

EMERGY BASIS OF FOREST SYSTEMS

By

DAVID ROGERS TILLEY

A DISSERTATION PRESENTED TO THE GRADUATE SCHOOL
OF THE UNIVERSITY OF FLORIDA IN PARTIAL FULFILLMENT
OF THE REQUIREMENTS FOR THE DEGREE OF
DOCTOR OF PHILOSOPHY

UNIVERSITY OF FLORIDA

1999

ACKNOWLEDGMENTS

The success of a graduate student is directly proportional to the care, friendship, and fellowship offered by family and friends. Conversely, the extent of ones academic career indicates how much love, support, and camaraderie was available. My extended educational experience was a success due to the unconditional support of both my old and new families. Thanks to my parents for faithfully professing the value of education and to my older siblings for graciously demonstrating and reinforcing this truism. A special loving thanks to Cathey for tolerating the emotional journey of graduate student life.

Special thanks go to my committee members: Dr. Mark Brown for offering intellectual guidance, keen insight, and patient support on top of his jovial character; Dr. H.T. Odum, a man with the most powerfully, diverse intellect, for including me in his quest to educate the world on how to understand itself; Dr. Clay Montague for sharing his discerning disposition; Dr. Clyde Kiker for providing the economist's viewpoint on understanding the link between nature and humanity; and Dr. Wayne T. Swank for having the foreknowledge to appreciate the unique abilities of our work, and for committing research resources of the U.S. Forest Service to fund my doctoral stipend.

Financial support for this research was provided by the Coweeta Hydrologic Laboratory of the U.S. Department of Agriculture Forest Service, Mark T. Brown, principal investigator (contract # A8FS-9, 961-113).

TABLE OF CONTENTS

	<u>page</u>
ACKNOWLEDGMENTS	ii
LIST OF TABLES	vi
LIST OF FIGURES	viii
ABSTRACT	xiii
1 INTRODUCTION	1
Statement of Problem	1
Why Study Forests	2
Description of Concepts and Principles	3
Previous Emergy Evaluations of Forests, Watersheds, and Other Ecosystems	6
Description of Systems Studied	9
Plan of Study	16
2 METHODS	18
Systems Diagrams	18
Emergy Systems Evaluations	19
Computer Simulation Models	20
Environmental Driving Energies	25
Energy and Emergy of Wind	25
Emergy of the Calcium Cycle	25
Spatial Distribution of Empower in the Wine Spring Creek Watershed	26
Spatial Distribution of Soil Organic Matter, Wine Spring Creek Watershed	27
Spatial Distribution of Empower in North Carolina	27
Emergy of the U.S. Forest Products Industry	29
3 RESULTS	30
Emergy Evaluation of Forested Watersheds	30
Environmental Driving Energies	32
Imported Driving Energies	38

Internal Processes	39
Emergy of Forest Exports	45
Transformity of Forest Exports.....	47
Dynamic Simulation of Emergy in Forest Storages	48
Emergy Evaluation of Forest Economies	66
Macon County, North Carolina	69
North Carolina	76
U.S. Forest Products Industry	97
International Trade of Forest Products	112
Global Forest Stocks and Consumption.....	115
Emergy Indices for Overview of Forested Systems	118
Sensitivity of Emergy Simulation Models.....	124
Sensitivity of Emergy and Transformity to Depreciation and Export	124
Sensitivity of Species Simulation Model EMSPECIES	125
Comparing Curves of Empower-species and Species-area	128
Simulating Management Alternatives of Forest Ecosystems	130
Logging Rotation Schedules and Forest Empower.....	130
A Model for Simulating the Empower of Multiple Forest Benefits	137
 4 DISSCUSSION.....	 145
Summary.....	145
The Significance of Environmental Driving Energies to the Southern Appalachians.....	145
Values of Forests in the Southern Appalachian Mountains.....	145
The Importance of Forested Systems and Other Ecosystems to Economic Production.....	147
Incorporating the Temporal and Spatial Dynamics of Emergy and Transformity into Emergy Evaluations.....	148
Management Policies	149
New Solar Transformities	149
Emergy of Southern Appalachian Watersheds	151
Environmental Driving Energies and Empower Spectra	151
Emdollar Values of Forest Processes, Exports, and Storages.....	153
Comparisons of the Ecological-Economics of Forest Systems	156
Emergy Measures of Living Standard	156
Emergy Measures of Sustainability	157
The Dynamics of Emergy, Empower and Transformity.....	163
Calculating Transformities Dynamically.....	163
Accounting for the Energy Transformation Processes of the Landscape	164
Spatial Distribution of Empower in North Carolina.....	164
An Explanation for the Fluctuating Empower Spectra of North Carolina	167
Plans for Future Research.....	171
 GLOSSARY	 173

APPENDICES

A SOLAR TRANSFORMITIES USED FROM PREVIOUS WORK AND FOOTNOTES TO EMERGY EVALUATION TABLES175

B CALIBRATION OF EMERGYDYN AND EMSPECIES218

C WATER VAPOR SATURATION DEFICIT OF THE ATMOSPHERE OVERLYING LAND234

D CALCULATING ENERGY ABSORBED FROM WIND251

E SOLAR TRANSFORMITY OF MOUNTAIN DEEP HEAT AND EROSION257

F PROGRAM CODE FOR EXTEND BLOCKS USED IN SIMULATION MODELS266

G MISCELLANEOUS EMERGY EVALUATIONS.....274

REFERENCES287

BIOGRAPHICAL SKETCH296

LIST OF TABLES

<u>Table</u>	<u>page</u>
2-1	Emergy evaluation template for calculating solar emergy, emdollars, and solar transformity19
2-2	Rules for simulating the temporal dynamics of emergy (Odum 1996)21
3-1	Emergy evaluation of 1 ha of watershed 18, Coweeta, NC.34
3-2	Emergy evaluation of 1 ha of Wine Spring Creek watershed (ca. 1995)36
3-3	Empower and weathering rates for seven (7) sub-basins of Coweeta watershed.....40
3-4	Emergy evaluation of storages in one hectare of the forest at WS18 (Coweeta)50
3-5	OMITTED
3-6	Soil organic matter in WSC watershed by soil type65
3-7	Emergy evaluation of resource basis of Macon Co., N.C. ca. 199271
3-8	Summary of flows in Macon county, N. C. circa, 199274
3-9	Emergy evaluation of resource basis for North Carolina, ca. 199280
3-10	Emergy evaluation of resource storages of North Carolina, 199292
3-11	Summary of flows in North Carolina, ca. 199294
3-12	Emergy evaluation of forest growth in North Carolina99
3-13	Emergy evaluation of the logging industry in the United States, 1992100
3-14	Emergy evaluation of woodpulp production in the United States, 1990101
3-15	Emergy evaluation of paperboard production in the United States, 1990102
3-16	Emergy evaluation of paper production in United States, 1990.103
3-17	Emergy evaluation of plywood production in United States, 1990.104
3-18	Emergy evaluation of lumber production in United States, 1990.....105
3-19	Indices using emergy for overview of Wine Spring Creek watershed (1128 ha)119
3-20	Indices using emergy for overview of Macon county, N.C. 1992.....120
3-21	Indices using emergy for overview of North Carolina, 1992121
4-1	Summary of solar transformities calculated in this dissertation150

4-2	Emergy investment ratios of forested systems.....	160
A-1	Summary of solar transformities previously calculated and used in this dissertation.....	176
B-1	Calibration of EMERGYDYN for simulating biomass, energy, and transformity of wood in Coweeta watershed.....	219
B-2	Calibration of EMERGYDYN for simulating biomass, energy, and transformity of total organic matter in Coweeta watershed	223
B-3	Calibration of EMERGYDYN for simulating saprolite, energy, and energy per mass of saprolite (regolith) in Coweeta watershed	226
B-4	Calibration of EMSPECIES for simulating species abundance, stored energy, and energy per species in the WSC watershed.....	229
C-1	Derivation of the vertical profile of the annual water vapor saturation deficit (mb) by latitude	246
C-2	Energy (J) of water vapor saturation deficit by latitude and altitude.....	247
C-3	Solar transformity of the water vapor saturation deficit overlying the continents.....	250
D-1	Equations and data used to calculate annual wind energy absorbed in the Coweeta watershed.....	252
D-2	Equations and data used to calculate annual wind energy absorbed in the Wine Spring Creek watershed.....	254
D-3	Equations and data used to calculate annual wind energy absorbed within a 1000m prism overlying Macon County, N.C.	255
D-4	Equations and data used to calculate annual wind energy absorbed within a 1000m prism overlying North Carolina	256
E-1	Solar transformity and empower density of deep heat as a function of altitude	263
E-2	Solar energy per gram of mountain erosion as a function of altitude.....	264
G-1	Emergy evaluation of the University of Florida Arboretum.....	276
G-2	Evaluation of the emergy, water, and sediment budgets of the continents.....	280
G-3	Sediment and emergy budgets for the main river basins of N.C. based on historic, agriculture, and present day sediment yield	282
G-4	Emergy evaluation of North Carolina leaf tobacco, 1987	283
G-5	Computation of North Carolina trade in manufactured goods.....	286

LIST OF FIGURES

<u>Figure</u>	<u>page</u>
1-1	Location of Southern Appalachian Mountains, Macon County, Wine Spring Creek watershed, and Coweeta watershed within North Carolina.....10
1-2	Systems diagrams comparing the environmental--economic interface of Southern Appalachian watersheds for the period 1880-1920 (a) to the late 20th Century (b).....11
2-1	Systems diagram and equations for the model EMERGYDYN, used to simulated the energy, energy, and transformity of watershed storages.....22
2-2	Systems diagram and equations for the model EMSPECIES, used to simulated the species abundance, emergy of tree species, and transformity of tree species23
3-1	Systems diagram of the forested watershed (WS18) at Coweeta Creek31
3-2	Systems diagram of the environmental--economic interface of Wine Spring Creek watershed.33
3-3	Power (a) and empower (b) spectra of environmental energy inputs to Wine Spring Creek (squares) and Coweeta (circles) watersheds.....37
3-4	Emergy per gram of weathered rock as function of total suspended sediment concentration for streams in seven (7) sub-basins of Coweeta and for total discharge from of the six (6) continents and the globe41
3-5	Energy systems diagrams of the calcium cycle of ws18 at Coweeta watershed. A) driving energies and calcium kinetics, B) calcium budget, and C) emergy of calcium inputs, internal cycle, and output43
3-6	Tree species as a function of area (a) and as a function of annual empower (b) for high-elevation (>1200m) forest in the Wine Spring Creek watershed46
3-7	Energy systems diagrams of EMERGYDYN used to simulate dynamics of emergy accumulation for wood biomass of the Coweeta watershed. Calibration of energy and material flows (a) and empower sources (b)51
3-8	Simulation results of EMERGYDYN calibrated in Figure 3-7 for wood biomass of Coweeta. Time series of wood biomass, emergy of wood biomass, and transformity of wood biomass are shown.....52
3-9	Energy systems diagrams of EMERGYDYN used to simulate dynamics of emergy accumulation for total (live + dead) organic matter of the Coweeta

	watershed. Calibration of energy and material flows (a) and transformity and empower sources (b).	53
3-10	Simulation results of EMERGYDYN calibrated in Figure 3-9 for total organic matter of Coweeta. Gross production, respiration, and net production (a), empower and transformity of use and export (b), and transformity and emergy of storage (c) are shown	55
3-11	Energy systems diagrams of EMERGYDYN used to simulate dynamics of emergy accumulation for saprolite of the Coweeta watershed. Calibration of energy and material flows (a) and empower sources (b).....	56
3-12	Simulation results of EMERGYDYN calibrated in Figure 3-11 for saprolite (regolith) at Coweeta. Emergy, emergy per mass of saprolite, and quantity of saprolite are shown.....	58
3-13	Model EMSPECIES used to calculate tree species abundance and emergy stored as tree species for the Wine Spring Creek watershed. A) systems diagram of model EMSPECIES shown with calibration values for an area of 0.08 ha, B) tree species-area curves for elevations above 1200m: simulation results compared to observations made by K. Elliott (unpublished data, Coweeta Hydro. Lab.), and C) simulated emergy stored per tree species for elevations above 1200m.	59
3-14	Spatial distribution of environmental empower density in the Wine Spring Creek watershed. A) systems diagram demonstrating how upstream empower from rain and deep heat converge from the ridge line down to the mid-basin region which in turn feeds the stream channel. B) map of the total environmental empower density	62
3-15	Frequency distribution of environmental empower density in the Wine Spring Creek watershed.....	64
3-17	Elevation gradient of soil organic matter in Wine Spring Creek watershed. Average organic matter per soil type as a function of mean elevation of soil type.	67
3-18	Topographic coverage of Wine Spring Creek watershed (a) and spatial distribution of soil organic matter by soil type (b).....	68
3-19	Systems diagram of Macon County, North Carolina (1992).....	70
3-20	Summary diagram of emergy flows of Macon County, N.C. (1992).....	75
3-21	Power and empower spectra of the main resource inputs used in Macon County, N.C. (1992).....	77
3-22	Systems diagram of North Carolina (1992)	78
3-23	Map of the renewable empower density of North Carolina by county	82

3-24	Historical consumption of primary fuels and electricity in North Carolina in units of emergy (1960-1994).....	85
3-25	Map of purchased empower density of North Carolina by county.	86
3-26	Maps of growth in growing stock (a), forest cover (b), and additions to growing stock for North Carolina by county.....	87
3-27	Systems diagrams of North Carolina's water budget (a) and the water evaluated as emergy (b) (1990).....	89
3-28	Summary diagram of emergy flows of North Carolina (1992).....	95
3-29	Power (a) and empower (b) spectra of the main resource inputs used in North Carolina (1992).....	96
3-30	Systems diagrams of the emergy inputs to the individual sectors of the forest products industry. The sectors are: forest growth in North Carolina (a), logging (b), pulpwood (c), paperboard (d), paper (e), plywood (f) and lumber (g).	106
3-31	Systems diagram summarizing the emergy flow (a), transformities (b), and emergy-to-dollar ratios (c) for the U.S. forest products industry (1990)	110
3-32	The emergy-to-dollar ratio (sej/\$) as a function of solar transformity for major wood products.	113
3-33	Balance of international trade in forest products. Trade in forest products (logs, woopulp, and paper) between the NAFTA (North American Free Trade Agreement) countries (U.S., Canada, and Mexico). Values for the forest products traded are shown in US dollars (\$) and emdollars (Em\$) ...	114
3-34	International trade in forest products between the NAFTA countries (1990). From/to matrices of money exchange for (a) wood logs, (b) pulp, (c) paper, and (d) all wood products; and from/to matrices of emdollar exchange for (e) wood logs, (f) pulp, (g) paper, and (h) all wood products.....	116
3-35	Empower of the global forest harvest (1950-97).....	117
3-36	Spatial distribution of the emergy investment ratio (purchased to renewable) in North Carolina by county.....	122
3-37	Rank order distributions of North Carolina counties by (a) emergy investment ratio (purchased to renewable) and (b) total empower density of the year 1992.	123
3-38	Transformity of total organic matter (TOM) simulated with EMERGYDYN for the Coweeta watershed. a) time series when total loss (export + depreciation) was held to a constant fraction of 0.03 of storage and the partitioning between export and depreciation was varied, percentages refer to export/total loss; b) steady-state values from (a); c) depreciation was held to a constant fraction of 0.023 of storage while export was varied from 0.006 to 0.094 of storage.	126

3-39	Simulation of species area curves for Wine Spring Creek watershed and two tropical rainforests.	127
3-40	Species-area curve (a) and empower-species curve (b) for the forest of Wine Spring Creek (>1200m), the Arboretum at the University of Florida, Gainesville (see Appendix G for emergy evaluation), and the tropical rainforest at East Kalimantan, Borneo (Kartiwinata 1984).	129
3-41	Simulated temporal dynamics of the quantity, emergy, and transformity of wood biomass for a 100-year rotation (a) and 300-year rotation (b) schedule	131
3-42	Simulated steady-state value of the response of fore emergy to frequency of harvest. Energy systems diagram (a), yield--wood & emergy (b), emergy inputs (c), emergy yield ratio & environmental loading ratio (d), renewable fraction in yield & emergy sustainability index (e), and transformity of yield and forest (f)	134
3-43	MULTIBEN, a model for simulating the empower of multiple forest benefits given different management scenarios	138
3-44	Model MULTIBEN with sub-module added for simulating the sustainability of providing multiple benefits	142
4-1	Summary diagram of the emdollar value of the forcing factors and products of the of Wine Spring Creek watershed	146
4-2	North Carolina's per capita empower consumption and per capita gross state product.....	158
4-3	Emergy-to-dollar ratio of North Carolina from 1977 to 1994. Total empower used in N.C. per dollar of gross state product.	159
4-4	An empower difference spectra of the U.S. woodpulp production industry (1972 vs. 1990).....	166
4-5	A possible explanation for the dynamics observed in the empower spectra of the forest systems evaluated.....	168
4-6	Ratio of the mean transformity of forest yield (Y in Figure 3-42a) divided by average transformity of forest wood (Q in Figure 3-42a) calculated from the EMERGYDYN simulation model.....	169
C-1	Systems diagram of the hydrologic cycle overlaid with the heat budget of the atmosphere highlighting the role of the water vapor saturation deficit over land	240
C-2	Map of the vapor saturation deficit at the surface for a) June and b) December	241
C-3	Annual and seasonal meridional profiles of the mean zonal saturation deficit (mb) at the surface of the continents. (DJF--Dec, Jan, Feb; JJA--Jun,July, Aug).....	243
C-4	Mean monthly (1961-90) saturation deficit at the surface (1000 mb) of the continents for the globe and northern and southern hemispheres	244

C-5	Meridional profiles of mean zonal saturation deficit at various altitudes	245
C-6	OMITTED	
C-7	Vertical profile of saturation deficit for continents	248
C-8	Seasonal mean monthly saturation deficit along the 35th parallel.....	249
D-1	Profile of wind velocity over Coweeta watershed.....	253
E-1	Diagram illustrating how total heat flow decreased with altitude.....	261
E-2	Mean flow of deep heat versus elevation	262
E-3	Solar emergy per gram of mountain erosion as a function of altitude	265
F-1	Extend representation of model EMERGYDYN used of simulating the emergy an transformity of wood biomass of the Coweeta watershed	267
G-1	Systems diagram of the environmental-economic interface of the UF Arboretum, Gainesville, Florida.	275
G-2	Concentration of suspended sediment in continental river discharge as a function of (a) total empower of continental precipitation and (b) empower density of continental precipitation.	281

Abstract of Dissertation Presented to the Graduate School
of the University of Florida in Partial Fulfillment of the
Requirements for the Degree of Doctor of Philosophy

EMERGY BASIS OF FORESTED SYSTEMS

By

David Rogers Tilley

August 1999

Chairman: Mark T. Brown

Major Department: Environmental Engineering Sciences

A major question in natural resource management is how to integrate economic-use activities with the supporting ecosystems to maximize performance of the ecological-economic system. In this dissertation, the natural wealth of forested systems of three different sizes was evaluated with emergy: two watersheds of the Southern Appalachians, Macon County (N.C.), and North Carolina. Emergy is the total amount of energy of one form that was required directly and indirectly to make another form of energy. Values are reported as emdollars (Em\$) which represent the economic activity resulting from resource use.

Benefits provided by forested watersheds were quantified based on emergy required to develop and maintain each service or product. Total wealth contributed by the multiple-use Wine Spring Creek (WSC) watershed was 4300 Em\$/ha/y, and was divided among scientific research (3450 Em\$/ha/y), water yield (2060 Em\$/ha/y), recreation (1880 Em\$/ha), and timber (1440 Em\$/ha/y).

In the 1990's, timber accounted for 3% of world energy use, 1% in the United States, 9% in North Carolina, 14% in Macon County, and 8% in the WSC watershed. Forest ecosystems captured 53% of environmental energy in North Carolina, 81% in Macon County, and 100% in the WSC watershed. The importance of forest ecosystems to the U.S. economy were evaluated based on energy flows of the U.S. forest products industry and international trade of forest products in North America. In 1993, the U.S. had an annual trade surplus in forest products worth 63 billion Em\$.

Simple models were developed to explore the temporal and spatial dynamics of energy and transformity in forested watersheds. Transformity is the ratio of energy to energy; it measures position in the energy hierarchy of energy forms. Temporally, transformity and energy lagged energy levels in reaching steady-state. Spatially, energy from mountain uplands converged to the stream network, making water and its carved basin locations of high empower density.

A model, MULTIBEN, evaluated forest empower of multiple benefits given various combinations of economic investment in recreation and timbering. Maximum empower was found at an intermediate level of economic investment, suggesting that an optimum intensity of forest development exists.

CHAPTER 1 INTRODUCTION

Statement of Problem

At the end of the 20th century, a major question in forest resource management is how to integrate economic use activities with the supporting ecosystems to maximize performance of the ecological-economic system. Methods of evaluation that can quantitatively integrate across systems are needed so that resource managers and the public can make informed policy decisions regarding the environment and its multiple uses.

Ascertaining the value of the goods and services provided 'free' from forests and other environments has increased in importance due to a shrinking environmental base and an expanding, industrialized global economy (Daily, 1997). The world's annual energy flow is now three and a half times greater than what is capable from renewable resources alone due to our use of energy obtained from fossil fuels (Brown and Ulgiati, 1999). In the developed countries, fossil-fueled economies are often ten times more intense than would be capable if only renewable, environmental sources of energy were used.

Quantitative measures are needed that signify how necessary the services and products of forested ecosystems are to human endeavors. When abundant fossil fuels no longer exist, civilization may find itself once again relying heavily upon forest ecosystems for economic stability. If this occurs, an energetically grounded knowledge

of forested ecosystems will be necessary so that they may be managed for maximum ecological-economic benefit.

Specific Issues

The following questions were addressed in this dissertation.

1. In Southern Appalachian mountain watersheds, how does the empower contributed from different driving energies compare? What are the relationships between the driving empower and internal processes, watershed exports of goods and services, and the stores of materials, energy, and information?
2. How does the ecological-economic relationship change for forested systems as the scale of analysis shifts from Southern Appalachian watersheds to the county, the state, the U.S. forest products industry, and finally to international trade?
3. How are the temporal, spatial, and process dynamics of emergy, empower, and transformity of forested systems incorporated into emergy evaluations of forests?
4. What intensity of development of U.S. National Forests maximizes empower?

Why Study Forests

Civilization has forever acquired food, fuel, and fiber from its forests (Mather, 1990). The expansion and success of early Mediterranean civilizations, if not entirely reliant upon forest resources, was at least significantly aided by their presence. Hughes & Thirgood (1982) estimated that in ancient Greece and Rome 90% of forest biomass was used as fuelwood for cooking and metal working. Forests provided the raw material for such final products as houses, war machines, and writing material, in addition to providing foods such as nuts, berries, and wildlife. The governments of Greece and Rome understood the importance of maintaining productive forests so well that they assumed ownership of much forested land and restricted export of forest products (Mather, 1990).

Some researchers point to archeological finds as an indication that soil erosion, accelerated from harvesting hillslope forests, devastated the fertility of agricultural lands downslope and led to the collapse of ancient Mediterranean civilizations (Mather 1990).

Up to the beginning of the fossil fuel boom of the late 19th Century in the United States, forests were the main source of raw material for the naval stores industry; turpentines of gum, wood, and sulfate were produced along with pine oil, rosin, pitch, and tar. Turpentine farming began as early as 1606 in North America, but peaked in 1909 at 750,000 barrels per year (Kurth, 1952).

Today, forests are recognized as much for their production of material goods, as they are for their aesthetics, recreational amenities, biological preservation, maintenance of mineral cycles, soil conservation and water enhancement (Myers 1997). While National Forest lands in the U.S are increasingly being viewed as a last vestige of wilderness, the public debate on how best to manage those lands continues to intensify. What is needed to address public concerns is a better understanding of the value of non-marketed, as well as marketed, goods and services provided by forests.

Description of Concepts and Principles

This dissertation used systems diagramming, simulation modeling, and energy analysis to evaluate forested systems. Brief descriptions of the concepts behind each method follow.

Energy Systems Diagramming and Simulation Modeling

The energy systems language of Odum (1994), with its explicit mathematical and energetic definitions of symbols (see the Glossary for names and definitions of symbols), is helpful in describing system architecture in overview and in mathematical detail. At an

overview level, systems diagrams are a rigorous statement of how main units are organized and interact with external driving energies. To study system behavior over time or across space, the language can be used to develop computer models of any type of system.

Emergy Analysis

Emergy analysis is a form of energy analysis useful for evaluating systems that have multiple forms of driving energies. Emergy is defined as the total amount of energy of one form that was used directly and indirectly to make another form of energy (Odum, 1996). Thus, when the energy basis of any system is evaluated, the multiple forms of energy can be converted to emergy and expressed in a common unit. Proper energy systems analysis recognizes the unique properties of energy forms (e.g., solar radiation, chemical bonds of wood, river currents, electricity) by accounting for the emergy used in the supporting network. The end result being that emergy systems analyses of all processes occurring on earth draw the system boundary so as to include the ultimate energy source, the sun.

The fundamental premise behind emergy analysis is that different forms of energy have unique properties associated with their position in the universal energy hierarchy and that the position is accurately measured with the transformity. The transformity is defined as the emergy required to make a certain form of energy (Odum 1996). The transformity of solar radiation is defined as unity (1) so that all other energy forms can be expressed as solar emergy. The System International (SI) unit for energy is the joule (J), so the unit for solar emergy is the solar emjoule (sej). The unit for the transformity is solar emjoules per joule (sej/J). Forms of energy which occupy a higher position in a

chain of energy transformations have higher transformities (e.g., the transformity of electricity is greater than that of coal or wood). Definitions of terms used in the dissertation are given in the Glossary.

In the realm of peopled systems where market systems and money are used to exchange goods and services, it is sometimes convenient to express energy in terms of the currency that it is driving. When expressed in this manner the quantity is called emdollars ($Em\$$) and is defined as the amount of currency (e.g., dollars) being driven by a flow of energy. Energy is translated to emdollars by dividing energy flow by the average energy-to-money ratio of an economic system. The energy-to-money ratio is found by dividing total energy use by a measure of economic product such as the gross domestic product. In this dissertation, the solar emjoules associated with the use of a resource or an environmental energy were often also reported as North Carolina emdollars. These emdollars were found by dividing solar energy by the energy-to-dollar ratio of North Carolina (i.e., total energy use divided by gross state product).

System Self Organization for Maximum Empower

The principle that systems self organize to maximize empower (rate of energy use) was put forth by Odum (1996). It states that systems self-organize by emphasizing those structures and functions that can provide feedback to the production process in order to capture more empower. At least two different strategies of systems development can be explained with the principle. When energy (or resource) availability is high, as with a recently burned forest that has high nutrient availability, it is advantageous for the system to respond quickly by emphasizing fast growing units with little regard for the longevity of the unit. On the other hand, when there is not a great surplus of unused

energy (low availability), as with an old growth forest, net growth is minimal or non-existent, and long-lasting, large units are emphasized that promote tight material cycles and efficient energy use.

The principle of systems self-organization for maximum empower is the premise that behind using energy to value systems. It assumes that the self-organized system values its units and interconnections by how much energy they use. Productive functions that use a lot of energy are valued highly. Wasteful functions can use a lot of energy also, but only for a short while. They will be selected against because they do not feed back properly to increase system empower.

Previous Energy Evaluations of Forests, Watersheds, and Other Ecosystems

The energy systems analysis methodology has been used to evaluate watersheds and ecosystems since the 1970's with the most complete review given by Odum (1996). Many aspects of forest ecosystems, including watersheds, have been evaluated using energy (Doherty 1995; Odum 1995; Romitelli and Odum 1996; Romitelli 1997; Kharecha 1997; Orrell 1998; and Howington 1999).

Doherty (1995) evaluated the net energy yield of forest production systems which had rotation cycles ranging from fast (5 years) to slow (300+ years). Net energy yield to the economy was discovered to increase with longer forest rotation cycles.

The energy basis of self-organization of mountain watersheds was investigated for the east coast of Brazil (Romitelli 1997) and the Coweeta basin (Romitelli and Odum 1996). Chemical potential and geopotential energies of water were found to be coupled; the geopotential energy accumulated in the mountains was used to spread the chemical

potential in the lowlands to maximum benefit to the whole watershed. Use of the chemical potential energy of water, a measure of productivity, increased downstream.

Odum et al. (1987) and Diamond (1984) evaluated the environmental and economic empower of the Mississippi River basin. Transformity of the river's geopotential energy was found to increase downstream and suggested as a novel system for classifying stream orders. Empower within the Cache River watershed of Arkansas was found to converge downstream to the Black Swamp (Odum et al. 1998). Kharecha (1997) and Doherty et al. (1997) found that empower density of the forest ecosystems of Luquillo Forest in Puerto Rico increased as elevation decreased.

Orrell (1998) studied the relationship between ecosystem respiration and plant diversity for ecosystems throughout the world. The empower required to support the tree diversity of north central Florida was found to be on the order of 1×10^{20} solar emjoules per species per year. Keitt (1991) related empower to tree diversity in the Luquillo Experimental Forest of Puerto Rico. Empower requirements were discovered to increase as the square of the number of tree species.

The spatial distribution of empower in watersheds was related to phosphorus cycling for the Upper Kissimmee River basin of central Florida (Boggess 1995) and for the karst-dominated St. Mark's watershed in the Florida panhandle (Parker 1998). In both watersheds, empower was found to increase downstream.

Howington (1999) evaluated the emergy of a Colombian-Venezuelan watershed and developed policy plans based on results. Methods for evaluating the spatial dynamics of the emergy of river water were refined.

Emergy evaluations and computer minimodels of tropical forests and their economic interfaces were developed to explore the ramifications of various public policy alternatives (Odum 1995). The environmental empower density of one (1) hectare of tropical forest was found to be $630 \text{ E}12 \text{ sej/ha/y}$. The environmental empower was matched by $120 \text{ E}12 \text{ sej/ha/y}$ of goods and services, $41 \text{ E}12 \text{ sej/ha/y}$ of fuels, and $546 \text{ E}12 \text{ sej/ha/y}$ of tourism. This represented an emergy investment ratio of 1.12. The 153 species of trees in the Luquillo National Forest were determined to represent a storage of $1.18 \text{ E}23 \text{ sej}$. Minimodels developed included: MATCHUSE that evaluated the emergy yields of wood sales and non-marketed goods and services, for a forest with competing woody and non-woody species; CACAO which evaluated the ecological interactions and economic yields of harvesting an understory crop; ELVERDE explored the relationship between nutrient cycling and gross productivity; and CLIMAX looked at the effects of wood harvesting on biodiversity. A systems diagram of moderate complexity was given for the El Verde forest at Puerto Rico which included such forcing factors as sunlight, wind, vapor, heat, nitrogen, carbon dioxide, rain, atmospheric deposition, and geologic uplift, and internal components such as seedlings, trees, epiphytes, earthworms, insects, and soil properties.

In an effort to determine the total benefits of recycling building materials, Buranakarn (1998) evaluated the emergy needed to make plywood and lumber in the United States. The transformities for softwood and hardwood plywood were $6.3\text{E}4 \text{ sej/J}$, while the transformity of lumber was determined to be $4.6 \text{ E}4 \text{ sej/J}$.

McGrane (1998) estimated the emergy associated with the main lithospheric units: cratons, mountains, and continental and oceanic sediments. The global average

energy per gram of mountain-material cycled was found to be on the order of 2×10^9 solar joules per gram. This was less than that found for the continental platforms (cratons), and greater than ocean sediments.

Descriptions of Systems Studied

The Southern Appalachian Mountains are centered in western North Carolina, but cross into northern Georgia and eastern Tennessee (Figure 1-1). The region was uplifted during three (3) mountain building episodes: the Taconic Orogeny during the Ordovician (505-438 million years ago); the Acadian during the Carboniferous (360-290 mya); and finally by the Alleghenian Orogeny of the Permian (290-245 mya) (Beyer 1991). The region is home to the highest mountain peaks in the eastern U.S (e.g., Mt. Mitchell and Clingman's Dome). Headwater streams for the Tennessee, Savannah, Chatahoochee, and Yadkin-Pee Dee drainage basins are located in the region. The U.S. National Forest Service and National Park Service manage a significant portion of the land as the Pisgah and Nantahala National Forests and the Great Smokey Mountain National Park.

Figure 1-2 shows how the energies driving the ecological-economic system of the Southern Appalachians changed over the past 120 years. At the end of the 19th Century, local "mountaineers" populated the valleys, subsisting mainly on natural resources but with a small amount of trade (Lewis et al. 1978). During this period, logging and mining companies moved down from the northeast U.S. into the region and bought timber and minerals rights from the mountaineers. When timber was extracted from the steep mountain slopes, the relatively small area of farmland held by mountaineers in coves was devastated by erosion (Whisnant, 1994).

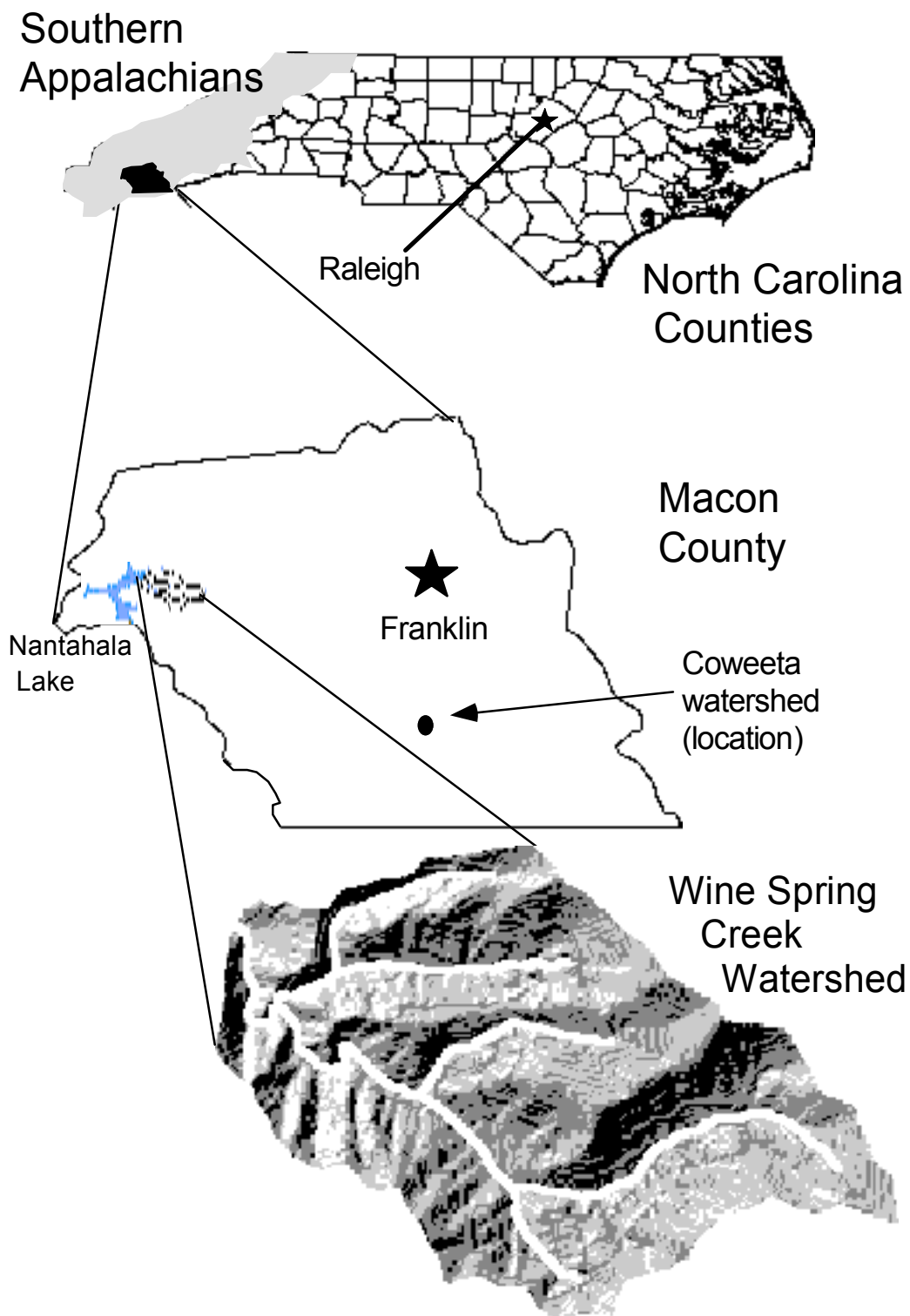

Figure 1-1. Location of Southern Appalachian Mountains, Macon County, Wine Spring Creek watershed, and Coweeta watershed within North Carolina.

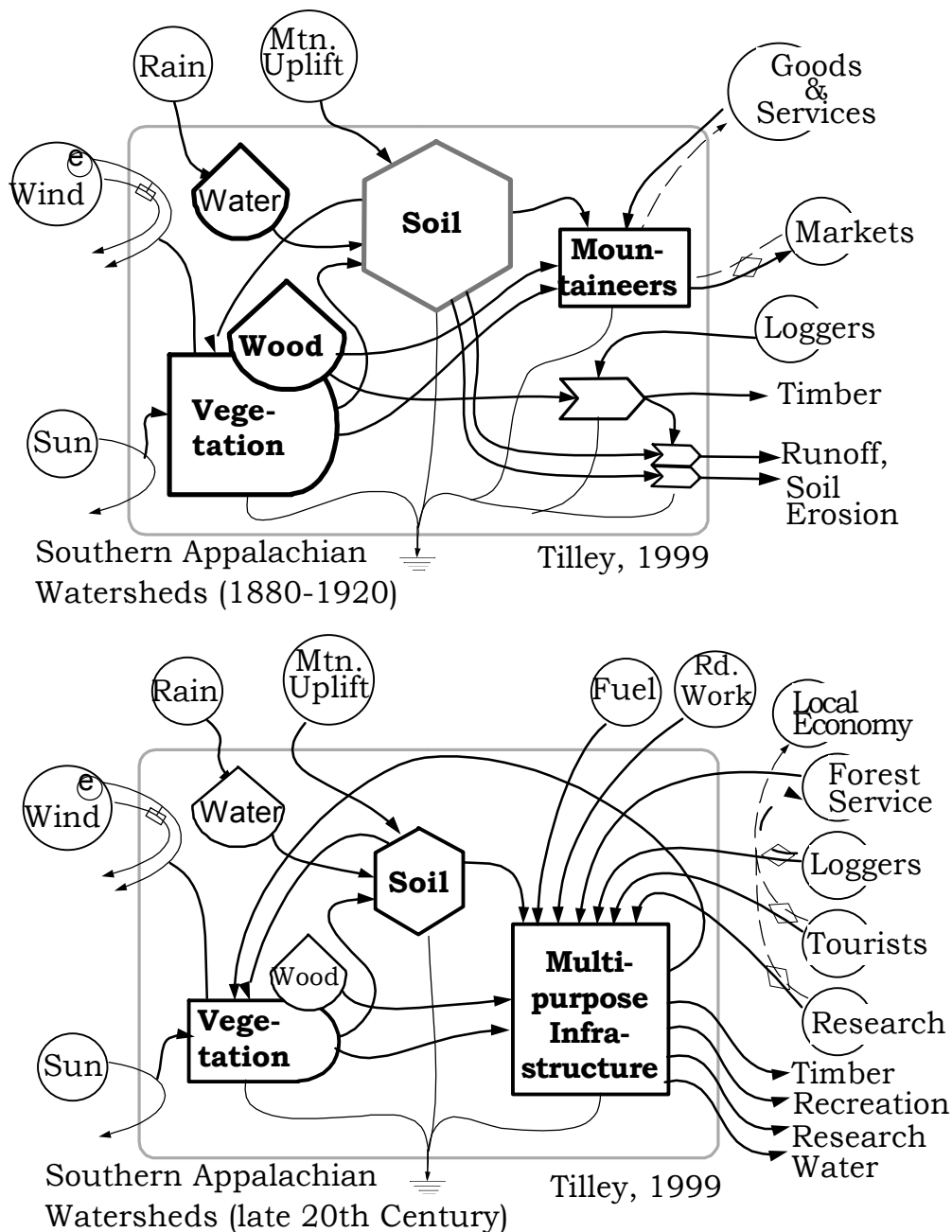

Figure 1-2. Systems diagrams comparing the environmental--economic interface of Southern Appalachian watersheds for the period 1880-1920 (a) to the late 20th Century (b). In the earlier period, mountaineers farmed the coves and depended little upon trade. During this period, capitalists from the north logged the old-growth forests, causing heavy soil erosion and accelerated water runoff (Whisnant 1994). At the end of the 20th Century, the region's economy relied heavily upon tourism, but timbering was still significant. The U.S. Forest Service managed a large portion of the land and promoted research on forestry management.

By the end of the 20th Century, the region had broadened its spectra of driving energies and developed into a recreational and tourist haven for the eastern United States, and once again supported a substantial timber industry with its vast forests (Southern Appalachian Assessment, 1996).

The State of North Carolina

North Carolina spans over 800 km from the Atlantic Ocean to the Appalachian Mountains. The state has the most diverse topographic relief of all states east of the Mississippi. The extensive lowland region of the east is known as the Coastal Plain, the rolling landscape of central North Carolina is called the Piedmont Plateau, and the rugged, high-peaked Southern Appalachian Mountains of the west are also referred to as the Blue Ridge province. The state's 135,531 km² (52,286 sq. mi.) is situated between latitudes 33.5N and 36.5N, and longitudes 75.5N and 84.3N.

The mean annual temperature for the state is 15°C, but varies along an east-west gradient with the Coastal Plain averaging 16.7°C, the Piedmont 15.5°C and the Mountains 12.8°C (NC Dept. of Conservation and Development, 1988). Under Koppen's climatological system, the state falls under the humid sub-tropical classification.

During the 1990's the population of North Carolina surpassed seven (7) million inhabitants. Although agriculture and forestry historically contributed significantly to the economy, high-technology manufacturing, research, and banking have gained prominence.

The County of Macon (North Carolina)

Macon county encompasses 134,000 ha of the southern Appalachian Mountains of western North Carolina (Figure 1-1). Altitudes within the county range from 600 m where the Little Tennessee River crosses into Swain County to over 1600 m. The mean elevation is 988 m. Climate is marine tropical with abundant precipitation (1350 mm y^{-1}) that includes some snowfall. Summers are warm while winters are mild to cold. Franklin is the county seat and largest city with 42% of the county's 23,500 (1992) residents (US Census Bureau 1996).

The Watershed of Wine Spring Creek

The 1130 ha Wine Spring Creek (WSC) watershed lies within the Nantahala National Forest of the North Carolina Blue Ridge physiographic province in western Macon county (35° Latitude, 83° Longitude; see Figure 1-1). Elevations in the basin range from 1660m at Wine Spring Bald to 900m at Nantahala Lake. The basin is unpopulated (U.S. Forest Service, 1995), but receives over 10,000 tourists per year (Cordell et al. 1996). The ~ 1800 mm of annual rainfall is evenly distributed throughout the year with more than 100mm of rain falling each month. Mean temperatures in January and July are 3.3 and 22°C , respectively (Swift et al. 1988).

The Wine Spring Creek Ecosystem Demonstration project, a research effort to quantify effects of several forest management prescriptions, was begun in 1994 as a collaboration between the managers of the Wayah Ranger District; scientists of the Coweeta Hydrologic Laboratory and other Southern Research Station research work units; and scientists from seven universities (Swank 1998).

The Watershed of Coweeta Creek

The Coweeta Hydrologic Laboratory, a 2185 ha research station of the USDA Forest Service in southwestern North Carolina, was set up in the 1930's to study the effects of land management practices on the hydrology of mountainous terrain. Later the research scope was broadened to include ecosystem management and watershed response to natural and man-made disturbance (Swank and Crossley, 1988).

Watershed 18 (ws18), a 12.5 ha mixed hardwood sub-basin of the Coweeta basin that has been undisturbed since 1927, was investigated in this dissertation due to its pristine status and long-term research history. In ws18, elevations range from 993 m down to 726 m. The basin faces the NW with a mean slope of 52% (Swank and Crossley (1988)).

Solar radiation over the annual cycle varies from a minimum mean of $7.0 \text{ E6 J m}^{-2} \text{ d}^{-1}$ in December to a maximum mean of $19 \text{ E6 J m}^{-2} \text{ d}^{-1}$ in June (Swift et al. 1988). Mean monthly wind velocities are greatest from late fall through early spring, presumably from the passage of cold fronts. Winds are generally lighter from late spring to early fall.

The Coweeta Lab is situated in the "temperate rainforest of the East" where average annual precipitation is greater than 1900 mm and well distributed throughout the year with every month receiving more than 110 mm. Based on the difference between stream discharge (1034 mm/y) and precipitation in ws18, the average evapotranspiration is 2.48 mm/d (Swift et al. 1988).

The bedrock geology (Tallulah Falls Formation) consists of metasandstones rich in feldspar and biotite, interlayered with mafic volcanic rocks and aluminous schists (Hatcher 1988). Directly overlying the bedrock is the residual regolith known as

saprolite. It is subsoil which has formed from the *in situ* isovolumetric dissolution of the crystalline rocks into less dense (bulk density of $\sim 1.6 \text{ g/cm}^3$) material. Thus, it has high porosity which allows for enhanced storage of subsurface water and augmented base flow. Information on the saprolite was extracted from Velbel (1988). Swank and Douglass (1975) reported that the average depth to bedrock was $\sim 6\text{m}$ for the Coweeta basin, of which 95% was most likely saprolite. Uplift of land at Coweeta was estimated as 3.8 cm per 1000 years (Velbel 1988), giving a replacement time of 160,000 years for the saprolite.

Other Forested Systems

The energy budget of the University of Florida's Arboretum was evaluated and compared to the forest of Wine Spring Creek and several tropical forests of Malesia. The University of Florida Arboretum, located in Gainesville, was established in 1993 by Dr. Bijan Dehgan, Professor of Environmental Horticulture. There were 135 north central Florida tree species, each represented by three (3) individuals, planted on two (2) ha.

Data on tree species richness of Indo-Malayan rain forests on the islands of Borneo, Sulawesi, and New Guinea were compared to the tree diversity of the Wine Spring Creek forest to gain perspective on the energetic basis of tree species diversity. The forest at East Kalimantan (1.10°S , 116.5°E) is located 38 km north of Balikpapan on the island of Borneo at an altitude of 50 m (Kartawinata et al. 1981). Forest soils are alluvial and the annual rainfall is greater than 2300 mm, evenly distributed throughout the year. The Toraut forest (0.5°N , 124°E) of the northern peninsula of Sulawesi has alluvial soils derived from volcanic rocks and annual rainfall greater than 2100 mm (Whitmore and Sidiyasa, 1986). New Guinea forest, located in the Northern District of Papua, 160

km northeast of Port Moresby and 30 km inland from the coast, received ~2300 mm of annual rainfall (Paijmans 1970).

Plan of Study

To better understand the environmental and economic basis of forest wealth and to clarify policy alternatives, the emergy values of four (4) forested systems and their main units were evaluated using systems diagrams, emergy analysis, and computer simulation models. The suite of emergies, driving the processes of two forested watersheds in the Southern Appalachian Mountains ($\sim 1 \times 10^3$ ha), were evaluated to quantify their emergy contributions to the forest. The many benefits provided by forests, such as wood, water, preservation of species diversity, tourism, and biogeochemical cycling, were also quantified as part of the evaluation of forest units. Macroscopic mini-simulation models and geographic information system-based models were used to explore temporal and spatial dynamics of emergy and transformity of forested watersheds.

To determine the value of the goods and services contributed by forest ecosystems to the economy, emergy evaluations of the economies of Macon County, N.C. ($\sim 1 \times 10^5$ ha) and North Carolina ($\sim 1 \times 10^7$ ha) were completed along with an emergy analysis of the United States forest products industry. International trade in forest products was assessed with emergy, using the North American Free Trade Agreement (NAFTA) between the U.S., Canada and Mexico as the case study. Finally, the total world consumption of wood was evaluated in terms of emergy.

More specifically, the following analyses of forests, forest components and processes, and forest products and services were undertaken:

1. To understand the relative importance of driving energies to the forested watersheds of the Southern Appalachians, power and empower spectra were developed.
2. To include the work of the atmosphere's water vapor saturation deficit in driving transpiration (productivity), the mean global transformity of the vapor deficit was calculated and included as a climatic input in emergy evaluations of all forested systems.
3. To determine how empower density and transformity of mountain energies changed with altitude, altitude-specific transformities for earth deep heat were calculated by accounting for the supporting emergy base.
4. To value biogeochemical cycling of forested watersheds, emergy of the calcium cycle was computed.
5. To determine the value of National Forest lands as reserves for preserving species, emergy was related to tree diversity with species area curves and a simulation model.
6. To determine the total benefit of the multiple uses (recreation, research, timbering) and products (water yield) of the Wine Spring Creek watershed, the product of each use was evaluated as emergy.
7. To explore how emergy and transformity of main forest units change over time, dynamic computer models were developed and simulated.
8. To see how dynamic emergy models could be used in sustainable forestry management, temporally dynamic emergy models of forest units were developed. The models were used to explore the effects of logging rotation cycles and various levels economic investment in recreation and logging on total empower, sustainable empower, wood yield, environmental loading ratios, and emergy yield ratios.
9. To understand how empower and transformity change spatially, Geographic Information System (GIS) models were developed for the Wine Spring Creek watershed that converged upland empower to stream channels.
10. To gain perspective on the level of economic activity supported by forests, emergy evaluations of Macon County, N.C., North Carolina, the U.S. forest products industry, and North American trade in forest products were conducted.
11. To see how emergy, transformity, and ratios of emergy-to-money changed for wood products throughout the ecological-economic system, emergy evaluations of the U.S. forest products industry were executed.

CHAPTER 2 METHODS

The general approach in this dissertation was to use systems diagramming, energy evaluations, and dynamic simulation models to explore the energy basis of forest wealth. A detailed description of each method is given in this chapter.

Systems Diagrams

To gain an overview perspective on the systems evaluated, system diagrams were drawn with the energy systems language (Odum 1994, see Appendix A for definition of symbols). The process of developing each energy systems diagram was as follows:

1. The spatial and temporal boundaries of the system were defined,
2. A list of exogenous energy sources that crossed the system boundary was formulated,
3. The internal units (state variables) of concern--those considered to vary over time--were listed,
4. Preliminary, complex diagrams of the systems were drawn, arranging all driving energy sources and internal components according to their transformity,
5. Driving energy sources and components were connected with appropriate pathways,
6. Symbols of complex diagrams were aggregated, reducing visual complexity to increase understanding of overall system organization.

The system diagrams were then used as the foundation for creating the energy evaluation tables. The system diagrams were also used as the basis for developing computer simulation models.

Emergy Systems Evaluations

The energy of flows and storages of the systems investigated were evaluated in energy and mass and then converted to emergy. The methodology of emergy evaluation was to construct a system diagram that included all flows and storages thought to be important and then to construct an emergy evaluation table from the diagram. Each energy or material crossing the system boundary appeared as a line item in the emergy table. A table like that in Table 2-1 was developed for each system based on its systems diagram. Table 2-1 demonstrates how energy and material flows were converted to solar emjoules by multiplying by solar transformity. The emdollars of a flow or storage were found by dividing the solar emergy by the mean emergy-to-dollar ratio of the regional economy (NC_{EDR}). Unless calculated within this work or otherwise noted, transformities used in this research were taken from Odum (1996). Generally, transformities of environmental inputs (e.g., solar radiation, rain) were based on global data, and thus represent global means.

Table 2-1. Emergy evaluation template for calculating solar emergy, emdollars, and solar transformity

Note	Item	Physical Units (J, g, \$, etc)	Solar emergy per unit sej/J, sej/g, sej/\$)	Solar Emergy (sej)	Emdollars* (NC Em\$)
<u>Inputs:</u>					
1	A	E_a	T_a	$M_a = E_a \times T_a$	$Em\$_a = M_a / (NC_{EDR})$
2	B	E_b	T_b	$M_b = E_b \times T_b$	$Em\$_b = M_b / (NC_{EDR})$
<u>Outputs:</u>					
3	C	E_c	$T_c = M_c / E_c$	$M_c = M_a + M_b$	$Em\$_c = M_c / (NC_{EDR})$

Note: NC_{EDR} = emergy-to-\$ ratio of North Carolina

Transformities for inputs were generally based on a system of larger scale. The transformity of outputs, on the other hand, were calculated for the system evaluated. In

Table 2-1 the transformity of C (T_c) was calculated by dividing the total input emergy (M_c) by the energy of C (E_c). If however, the two inputs were from the same source of emergy, the greater of the two inputs were taken as the emergy input to avoid double counting.

Computer Simulation Models

Computer models were developed with the iconographic simulation software Extend® to explore the dynamics of forest emergy. The process of developing models was as follows:

1. using the Extend® software, pre-programmed energy systems icons represent sources, interactions and storages were positioned on the modeling worksheet and connected (since the icons were pre-programmed with mathematical definitions, the differential equations were created once the energy systems icons were connected),
2. the kinetics of models were calibrated by entering rates for pathways and states for storages directly into dialog boxes of energy systems icons (generally models were calibrated based on a steady state condition),
3. to simulate emergy, the transformity of sources was calibrated,
4. simulations were conducted and output (time series graphs) produced on screen.

See Tilley (1996) or Odum and Odum (in press) for more details on simulating energy systems models with Extend.

Odum (1996) suggested the general rules (see Table 2-2) for simulating emergy.

Table 2-2. Rules for simulating the temporal dynamics of emergy (Odum 1996)

Condition of energy storage	Rules for accumulation of emergy
Amount of energy stored is increasing	The gross accumulation of emergy is the sum of all inputs; The net accumulation is the gross less the export of 'usable' emergy.
Amount of energy stored is decreasing	Gross accumulation is zero; The loss of emergy equals the energy lost times its transformity.
Amount of energy stored is not changing	The accumulated emergy remains the same.

Two simulation models, EMERGYDYN and EMSPECIES, were developed to investigate the temporal dynamics of forest components and to explore the dynamic calculation of transformities

The first model, EMERGYDYN (Figure 2-1), was developed to simulate the temporal dynamics of forest storages, and the second model, EMSPECIES (Figure 2-2), was developed to simulate the emergy of tree diversity.

Figure 2-1 shows the system diagram and equations of EMERGYDYN. In EMERGYDYN a single storage of energy was a balance between production--an autocatalytic process driven by rain and deep heat--and losses from export and depreciation. Export was a loss from storage that carried away emergy with the same transformity as the storage, whereas depreciation was unavoidable loss from storage that did not subtract emergy.

Emergy inputs from rain and deep heat were the sources included because they are considered to be independent sources of emergy. Rain emergy is a co-product of the earth's biogeospheric system which is driven by sunlight, tides, and deep heat. This precludes adding sunlight as a source of emergy because it and rain are from the same

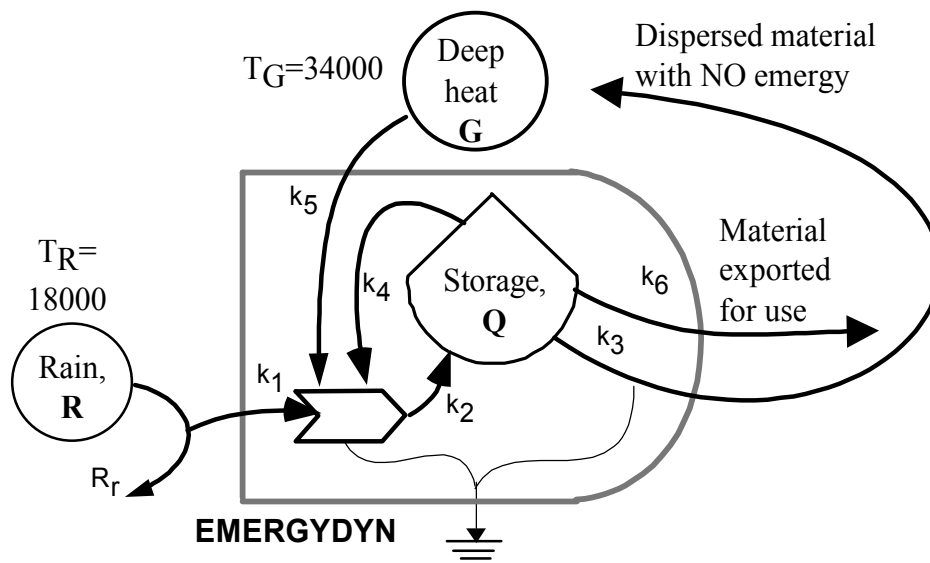

Equations for energy

R, & G are constant sources of energy;
Q is storage of energy.

$$R_r = R / (1 + k_1 QG)$$

$$dQ = k_2 R_r QG - k_3 Q - k_6 Q$$

Equations for energy

M_Q is energy of Q,
 T_R, T_G, T_Q are transformities of R,G,Q.

If $dQ > 0$

$$dM_Q = T_R(k_1 R_r QG) + T_G(k_5 R_r QG) - T_Q(k_6 Q)$$

If $dQ < 0$, then

$$dM_Q = T_Q(dM_Q)$$

Else

$$dM_Q = 0.$$

$$T_Q = M_Q/Q$$

Figure 2-1. Systems diagram and equations for the model EMERGYDYN, used to simulate the energy, energy, and transformity of watershed storages.

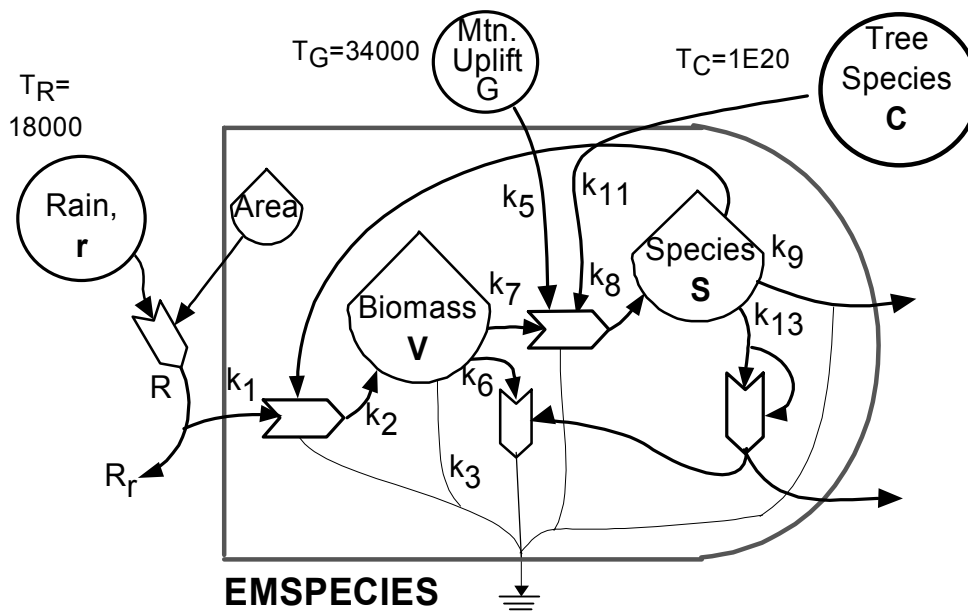

r, G & C are constants
 $R = r \times \text{Area}$
 $R_r = R / (1 + k_1 S)$

M_V, M_S : energy in V & S, respectively;
 $T_R, T_G, T_C, T_V, \& T_S$: transformity of rain, deepheat, new tree species, biomass, and stored tree species.

Equations of state:

$$dV = k_2 R_r S - k_3 V - k_6 V S^2 - k_7 V G C$$

$$dS = k_8 V G C - k_9 S - k_{13} S^2$$

If $dS > 0$ then,

$$dM_S = T_V * k_7 V G C + T_G * k_5 V G C$$

$$+ T_C * k_{11} V G C - T_S * k_9 S$$

Energy equations:

If $dV > 0$ then,

$$dM_V = T_R * k_1 R_r S - T_V * k_7 V G C$$

If $dV < 0$ then

$$dM_V = T_V * dV$$

Else $dM_V = 0$

If $dS < 0$ then

$$dM_S = T_S * dS$$

Else $dM_S = 0$

Figure 2-2. Systems diagram and equations of model EMSPECIES, used to simulate the species abundance, energy of tree species, and transformity of tree species.

energy source. Doing so would be double counting energy. Deep heat released from mountains, on the other hand, is considered to represent an energy contribution from an earth storage that was created long ago. Therefore, its source of energy was different from that which created rain and it can be added as an independent source of energy.

For each type of forest storage simulated with EMERGYDYN, the transformities of rain and deep heat were $1.8 \text{ E}4$ and $3.4 \text{ E}4 \text{ sej/J}$, respectively. Calibration values for production, depreciation, and export were specific to each forest component.

The mini-model EMSPECIES (Figure 2-2) was used to determine energy values of tree species. As previously proposed by Odum (1996), Orrell (1998), and Keitt (1991) respiration increased as the square of the number of species to account for the energetic loss of supporting not only more species, but more possible interactions between them. The number of species was a function of biomass, mountain uplift and the number of species available to colonize the forest (i.e., seeds).

Equations for simulating energy were programmed into EMSPECIES and transformities of driving energies (rain, earth deep heat, and species recruitment) were added so that the energy value of species diversity could be explored. The transformities were $1.8 \text{ E}4 \text{ sej/J}$ for rain, and $3.4 \text{ E}4 \text{ sej/J}$ for deep heat. The empower per tree species ($2 \text{ E}20 \text{ sej/y/tree species}$) was taken from Orrell's (1998) work in north central Florida.

Environmental Driving Energies

Energy and Emergy of Wind

A new methodology was developed and used for estimating the energy contributed from wind. First, wind speeds aloft (1000m) were approximated based on the general observation that, over land, near-surface speeds are 60% of speeds aloft (Barry and Chorley, 1992). Next, a vertical profile of wind speed was fitted to the two endpoints based on the curve-shape typically observed (Barry and Chorley, 1992). The total energy absorbed was found by numerically integrating the wind energy absorbed over the vertical profile in a spreadsheet (see Appendix D for details). The advantage of the method was that only near-surface wind speed data (typically reported at weather stations) were required.

Emergy of the Calcium Cycle

The emergy of the calcium cycle was investigated i) to refine the emergy methodology for evaluating nutrient cycles, ii) to develop baseline data on the calcium budget of a relatively undisturbed watershed, and iii) because calcium is an essential element for healthy forest growth that may become a limiting factor due to its scarcity in the bedrock.

Calcium enters the Coweeta watershed via three vectors: dryfall by wind (aeolian), wetfall from precipitation, and mineralization of bedrock. In forested watersheds, calcium and other minerals circulate among three major reservoirs: aqueous solution in the soil, live vegetation, and soil organic matter.

The fluxes and reserves of calcium and other nutrients (Mg, K, P, S, N, Na) in the Coweeta basin (WS18) were derived from Swank and Waide's (1988) analyses of

precipitation and stream water chemistry, Monk and Day's (1988) calculations of the nutrient balance of vegetation, and Velbel's (1985) estimates of rock weathering and chemistry.

All of the external sources of energy that interact to operate the forest system are simultaneously cycling mineral nutrients. Therefore, the internal cycling of mineral nutrients is driven by the total empower of the watershed. For mountain watersheds, such as Coweeta, the independent sources of empower were rain, earth cycle (deep heat), and atmospheric deposition. (See the previous section on calibrating EMERGYDYN for an explanation of why rain and deep heat were independent energy sources).

As for the atmospheric deposition, it was considered an independent source of energy as well. The majority of the minerals transported to the forest were of terrestrial origin, which means that they were eroded from land elsewhere (e.g., agricultural fields, forest fires). The forests gained minerals that were lost by another system. Emergy accounting protocol subtracts the emergy of erosion, so the emergy gain can be added to the forest without double counting.

Bedrock weathering was a function of the rate at which the hydrosphere interacted with the lithosphere, with the process accelerated by the development of vegetation and soil. Thus, the emergy per mass of weathered bedrock was determined by adding the empower of rain and deep heat, and dividing by the weathering rate.

Spatial Distribution of Empower in the Wine Spring Creek Watershed

The spatial configuration of stream empower within the Wine Spring Creek watershed was developed by converging upstream empower, provided by rain and deep

heat, into the stream channels. The coverage was developed according to the following steps:

1. The elevation gradient of empower density for each incoming energy source, rain and deep heat, was developed by linearly interpolating between the low (900m) and high (1600m) extremes.
2. Topographic coverages (developed from DEM's--digital elevation models) were converted to empower density coverages based on the elevation gradient developed in step 1, and added to produce a coverage of incoming empower density.
3. A coverage of the stream network was developed using the routine in the GIS software ArcView that is generally used to define stream channels and watershed boundaries.
4. The convergence of empower to the stream channels was calculated by weighting upstream cells with their total empower density (rain plus deep heat) when running the same "hydrologic" routines in the GIS software.

Spatial Distribution of Soil Organic Matter in the Wine Spring Creek Watershed

The spatial distribution of soil organic matter was investigated based on soil data collected by Forest Service personnel and soil coverages produced by the USDA Soil Survey. Soil data was provided in tabular form along with a hard copy map of sampling locations, courtesy of H. McNab and S. Browning of the US Forest Service.

The average organic content of each soil type was determined from the soil database. The average elevation of each soil type was determined from the USDA soil survey. The elevation gradient of soil organic matter was then estimated by plotting average soil organic matter content of each soil type against its average elevation.

Coverages of soil organic matter plotted the average soil organic by soil type.

Spatial Distribution of Empower in N.C.

To investigate the spatial distribution of empower in North Carolina, coverages of environmental empower were developed and combined with a coverage of purchased

empower to create a coverage of emergy investment ratio (empower purchased to locally renewable).

The locally renewable empower of a county was the sum of rain, natural erosion, and waves. The spatial distribution of rainfall was simplified from a detailed map (Clay et al. 1975) into three divisions, corresponding approximately with the three physiographic provinces (Coastal Plain, Piedmont, and Blue Ridge). A similar spatial division was made for natural erosion based on Simmons' (1993) long-term investigation of the sediment yield from various types of drainage basins (i.e., pristine forest, agriculture, urban). Wave energy was added to the coastal counties based on coastline length. The length of coastline for each coastal county was measured from the GIS coverage.

The purchased empower for each county was estimated as the product of county income (\$/y), the emergy-to-\$ ratio of N.C. ($1.1 \text{ E}12 \text{ sej}/\$$), and a correction factor (1.92). The correction factor accounted for the difference between personal income and gross state product and was calculated here as gross state product divided by total personal income. County income was from 1990 (US Census Bureau, 1996).

The estimator of emergy imported to a county was a sole function of dollar flows and the renewable emergy was based only on rainfall, geologic uplift, and waves. The estimate of imported emergy could be improved by considering each county in detail, taking into account the emergy of fuel use, road construction, services of state government, activity at universities and colleges, and any other major source of emergy. The estimate of the renewable emergy inputs could be improved by considering use of groundwaters, rivers, and soils.

Emergy of the U.S. Forest Products Industry

The majority of data for the emergy evaluations of forest products came from four sources. The U.S. Census Bureau (1992) provided information on services, labor and capital as well as on the dollar value of production. A USDA Forest Service resource bulletin by Ulrich (1990) gave necessary statistics for total wood use by various economic sectors. Data on energy use came from the U.S. Department of Energy's Energy Information Administration (EIA 1991) and the American Paper Institute's annual reports (API, 1989). Minor amounts of data were supplied by Commerce Research Bureau (CRB 1996).

The trade in forest products between Mexico, Canada and the U.S. was evaluated by converting reported dollar flows of exports and imports (Lyke, 1998) into emergy flows based on each forest products emergy to dollar ratio that was calculated in this work. The emergy flows were then converted to emdollars using the average U.S. emergy-to-\$ ratio for 1995 ($1.5 \text{ E}12 \text{ sej}/\text{\$}$, Odum 1996).

CHAPTER 3 RESULTS

The results chapter is organized into two broad sections with several subsections within each. In the first section, results of the emergy evaluations of the Coweeta and Wine Spring Creek watersheds are given which include evaluations of the major internal processes and main storages. In the second section, the value of forest products to economic systems is addressed. The section comprises emergy evaluations of the economies of Macon County, N.C. and the state of North Carolina, including the contribution of forests. Also given in this section are results of the emergy evaluations of the forest products industry of the United States, and an emergy evaluation of the international trade in forest products. Finally, the historical (1950 to present) world consumption of wood was evaluated as emergy.

Emergy Evaluation of Forested Watersheds

The diagram in Figure 3-1 demonstrates not only the interconnectedness of the units of the Coweeta watershed (WS18), but also highlights the important role that external energy sources play in determining the architecture of the watershed. The energies of the meteorological system--solar radiation, kinetic energy of wind, atmospheric vapor saturation deficit, and rain--interacted with the ancient geology to create a mixed-hardwood forest with rich soils.

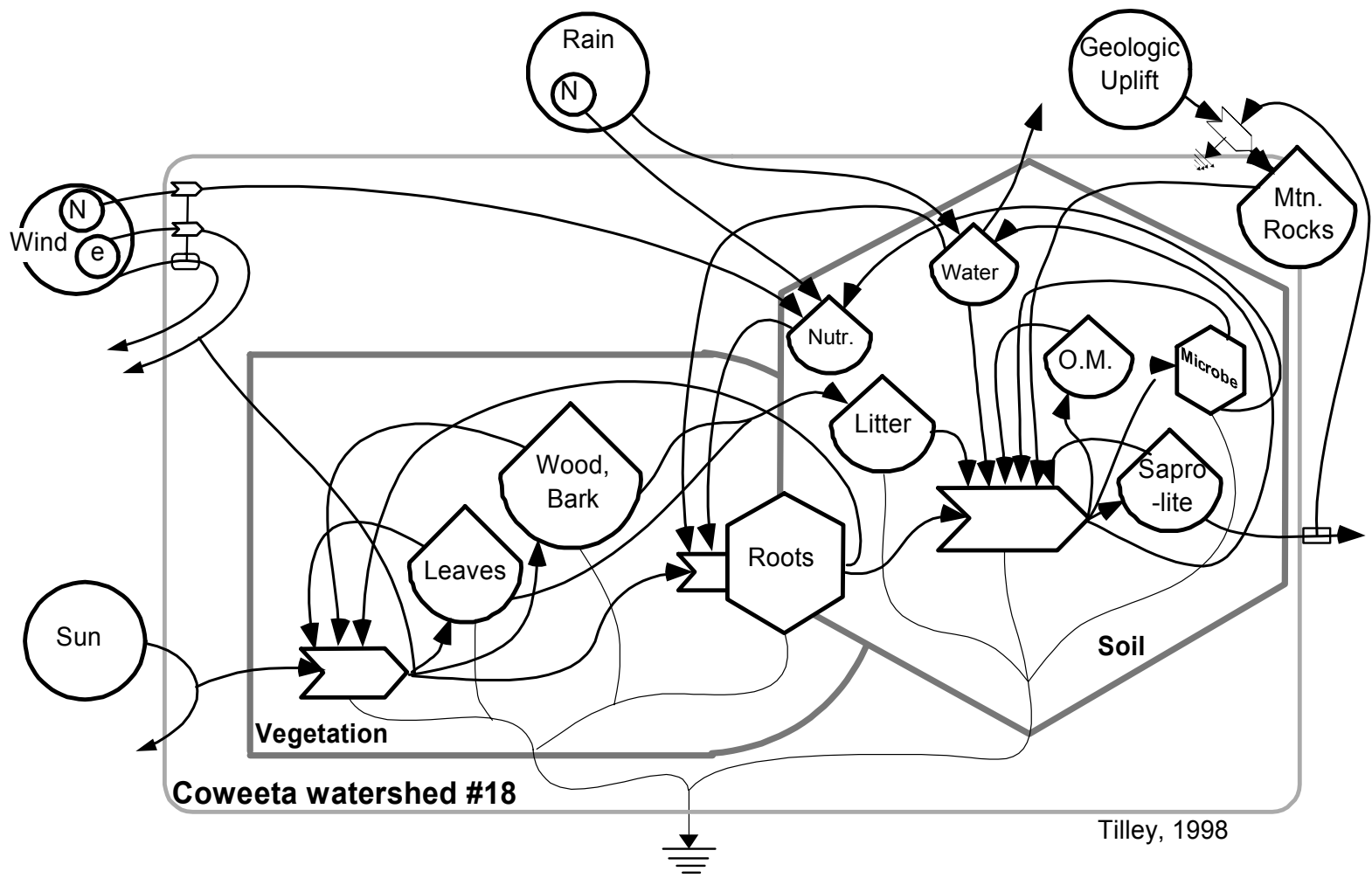

Figure 3-1. Systems diagram of the forested watershed (WS18) at Coweeta Creek (N-nutrients, e-water vapor, O.M.-organic matter).

Figure 3-2 shows the system diagram of Wine Spring Creek (WSC) watershed. The diagram emphasizes the multi-purpose role of the watershed. In addition to the forest and mountain capturing the energies of the environment (similar to the Coweeta watershed) the diagram reveals the interconnections of environment and economy, and highlights the fact that the environment is the basis of the human-built infrastructure and outside attraction.

The natural features of the watersheds were quite similar except for elevation--Coweeta (WS18) was lower, but public use of the watersheds represented two different cases for the Southern Appalachian Mountains. WS18 was chosen for the analysis because it represented a relatively pristine watershed with little economic activity, other than scientific investigation and Forest Service management, and because it has been heavily studied over the past 50 years. The WSC watershed on the other hand had significant economic inputs in the form of tourists, scientists, Forest Service management, and timbering activities.

In the sections that follow, the empower of each environmental energy (sunlight, atmospheric deposition, wind, water vapor, rain, and mountain uplift) was evaluated for the two watersheds, Coweeta WS18 (Figure 3-1) and Wine Spring Creek (WSC; Figure 3-2) and used to determine values for watershed processes, storages, and exports. Imported energies were evaluated for the WSC watershed, as well as its economic outputs.

Environmental Driving Energies

Table 3-1 lists each of the environmental energies used at Coweeta WS18. In order of the amount of emergy contributed they were: chemical potential of rain

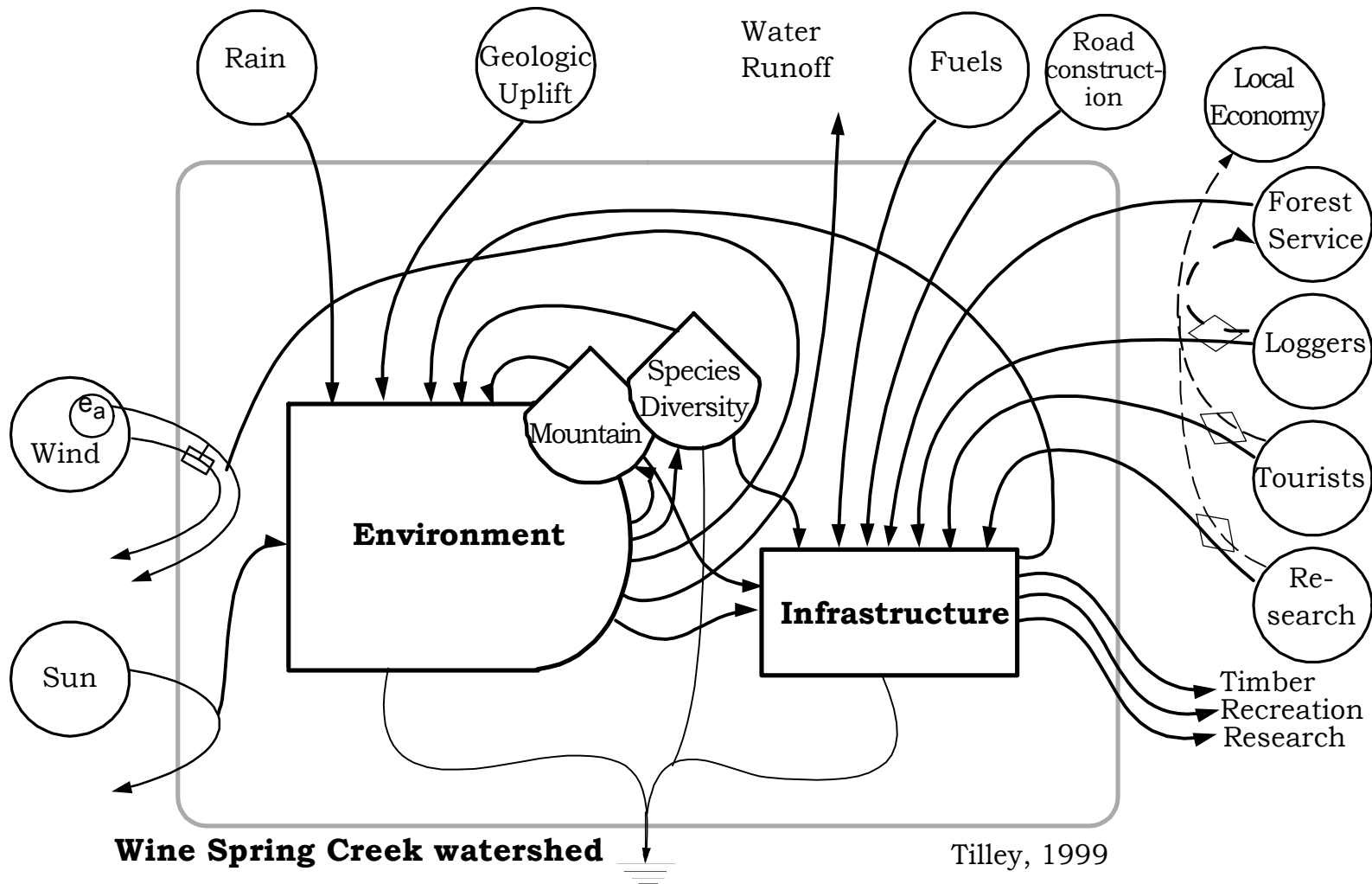

Figure 3-2. Systems diagram of the environmental--economic interface of Wine Spring Creek watershed.

Table 3-1. Emery evaluation of watershed 18 (WS18), Coweeta Hydrologic Lab (annual flows per ha).

Note	Item	Physical Unit	Emery per unit (sej/unit)	Solar Empower (E12 sej)	Emdollar Value (1992 Em\$)
ENVIRONMENTAL ENERGY SOURCES:					
1	Sunlight	5.0E+13 J	1	50	45
2	Vapor saturation deficit	1.2E+12 J	5.9E+02	715	650
3	Wind, kinetic	1.9E+11 J	1.5E+03	281	256
4	Water evapotranspired	4.5E+10 J	1.8E+04	814	740
5	Precipitation, chemical	9.6E+10 J	1.8E+04	1744	1586
6	Deep heat	1.4E+10 J	3.4E+04	462	420
7	Precipitation, geopotential	1.4E+10 J	1.0E+04	141	128
8	Atmospheric deposition	3.0E+04 g	1.0E+09	30	27
9	Ca as dryfall (wind)	9.1E+02 g	1.0E+09	1	1
10	Ca as wetfall (rain)	3.7E+03 g	1.0E+09	4	3
11	Ca from rock weathering	1.8E+04 g	4.6E+09	84	76
INTERNAL PROCESSES (transformities calculated)					
12	NPP, total live biomass	2.1E+11 J	6.1E+03	1306	1187
13	NPP aboveground	1.2E+11 J	1.1E+04	1306	1187
14	Root NPP	8.8E+10 J	1.5E+04	1306	1187
15	Wood accumulation	6.2E+10 J	2.1E+04	1306	1187
16	Litterfall	6.4E+10 J	2.0E+04	1306	1187
17	Leaf production	6.2E+10 J	2.1E+04	1306	1187
18	Rock weathering	4.8E+05 g	4.6E+09	2237	2033
19	Calcium cycle	8.4E+04 g	2.7E+10	2237	2033
20	Total mineral cycle	3.6E+05 g	6.2E+09	2237	2033
EXPORT (transformities calculated)					
21	Stream discharge (chem)	5.1E+10 J	4.4E+04	2237	2033
	Stream discharge (geo)	6.4E+10 J	3.5E+04	2237	2033
	Stream discharge (mass)	1.0E+10 g	2.2E+05	2237	2033
22	Calcium export	7.0E+03 g	2.7E+10	186	169
23	Dissolved mineral export	1.5E+05 g	6.2E+09	926	842

NPP - net primary production

Empower for primary production: evapotranspiration + deep heat + atmos. deposition.

Empower for rock weathering, Ca cycle, and stream discharge: rain + deep heat + atmos. deposition.

Transformity = annual empower divided by annual energy flow.

Footnotes to Table 3-1 appear in Appendix A

(transpiration), water vapor saturation deficit, geologic uplift (deep heat), wind (physical), geopotential of rain, sunlight, and atmospheric deposition.

In Table 3-2 the environmental energies of WSC are shown. The rank order was different from Coweeta WS18: geopotential of rain, chemical potential of rain (transpiration), geologic uplift (deep heat), water vapor saturation deficit, wind (physical), sunlight, and atmospheric deposition.

From Table 3-1 the total incoming environmental empower for the Coweeta watershed (2240 E12 sej/ha/y; 2040 Em\$/ha/y) was found by summing the three (3) sources which had independent sources of energy: chemical potential of rain, deep heat, and atmospheric deposition.

Based on identical energy sources, WSC (Table 3-2) had approximately the same total environmental empower (2260 E12 sej/ha/y, ~2060 Em\$/ha/y).

Figure 3-3 shows power (rate of energy) and empower (rate of energy) spectra, highlighting the differences and similarities in environmental inputs to Coweeta and WSC watersheds. When graphed as power used versus transformity (Figure 3-3a) the graph demonstrated the hierarchical property of energy quality. Energy of low transformity (e.g., sunlight) was more abundant than energy of high transformity (e.g., deep heat).

Figure 3-3b compares the empower spectra of the two watersheds. Normalizing energy to solar energy corrected the vast discrepancies in the quantitative differences contributed by energy sources. All energy flows were within an order of magnitude of each other.

Table 3-2. Emergy evaluation of Wine Spring Creek watershed (annual flows per ha, ~1995).

Note	Item	Physical Unit		Emergy per unit (sej/unit)	Solar Empower (E12 sej)	Emdollar Value (1992 Em\$)
ENVIRONMENTAL ENERGY INPUTS:						
1	Sunlight	5.0E+13 J		1	50	46
2	Vapor saturation deficit	7.2E+11 J		5.9E+02	423	384
3	Wind, kinetic (annual)	1.9E+11 J		1.5E+03	281	256
4	Precip., geopotential	5.6E+10 J		1.0E+04	577	525
5	Hurricanes (long term)	5.2E+10 J		1.0E+04	522	474
6	Precip., chemical	9.7E+10 J		1.8E+04	1763	1,603
7	Transpiration	2.7E+10 J		1.8E+04	484	440
8	Deep heat	1.4E+10 J		3.4E+04	468	425
9	Atmospheric deposition	3.0E+04 g		1.0E+09	30	27
IMPORTED ENERGY SOURCES:						
10	Auto-fuel, visitors within	2.1E+08 J		6.6E+04	14	12
11	Auto-fuel, thru traffic	2.1E+09 J		6.6E+04	136	124
12	Visitors, length of stay	8.6E+07 J		8.9E+06	768	699
13	Timbering, services	9 \$		1.5E+12	13	12
14	Timbering, fuels	1.6E+07 J		6.6E+04	1	1
15	Road maintenance	88 \$		1.5E+12	133	121
	Forest Service	13 \$		1.5E+12	20	18
16	Researchers time	4.0E+06 J		3.4E+08	1377	1,252
INTERNAL PROCESSES (transformities calculated):						
17	NPP, total live biomass	2.1E+11 J		4.7E+03	982	892
18	Wood accumulation	6.2E+10 J		1.6E+04	982	892
19	Litterfall	6.4E+10 J		1.5E+04	982	892
20	Rock weathering	6.0E+05 g		3.8E+09	2261	2,055
21	**Tree diversity	30 species		3.3E+13	982	892
EXPORTS (transformities calculated):						
22	Stream discharge (chem)	7.0E+10 J		3.2E+04	2261	2,055
	Stream discharge (geo)	1.3E+11 J		1.8E+04	2261	2,055
	Stream discharge (mass)	1.4E+10 g		1.6E+05	2261	2,055
23	Timber w/out service	4.1E+09 J		3.0E+04	124	113
	Timber with service	4.1E+09 J		7.0E+04	291	264
24	Recreated people	8.6E+07 J		2.4E+07	2065	1,877
25	Research information	1.2E+03 J		3.1E+12	3790	3,446
26	Total export (items 6, 8-16)				4722	4,293

** Tree diversity varies with sampling area, 30 species observed in first ha sampled.

Footnotes to Table 3-2 appear in Appendix A

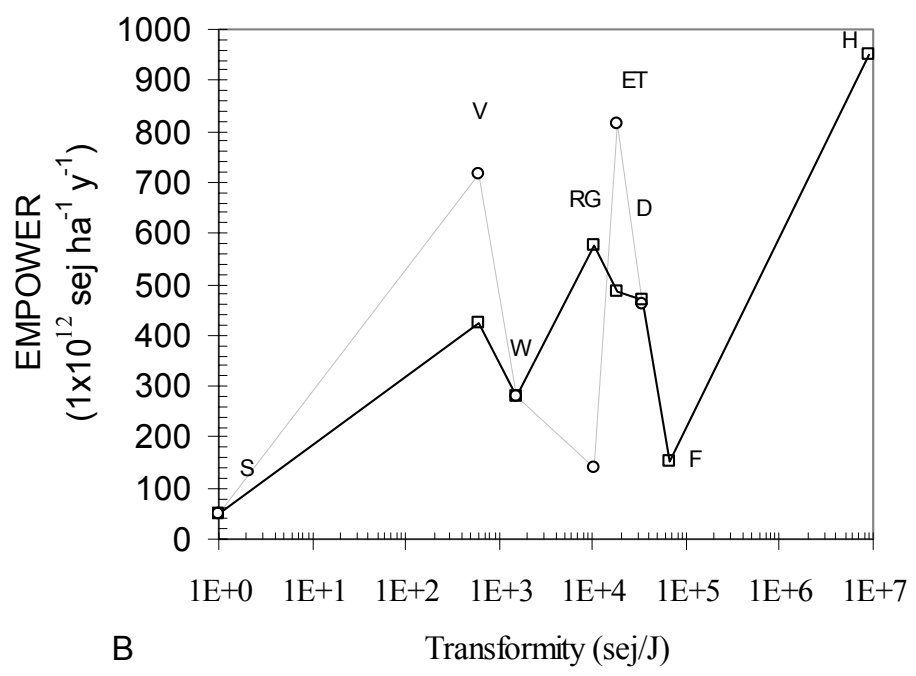
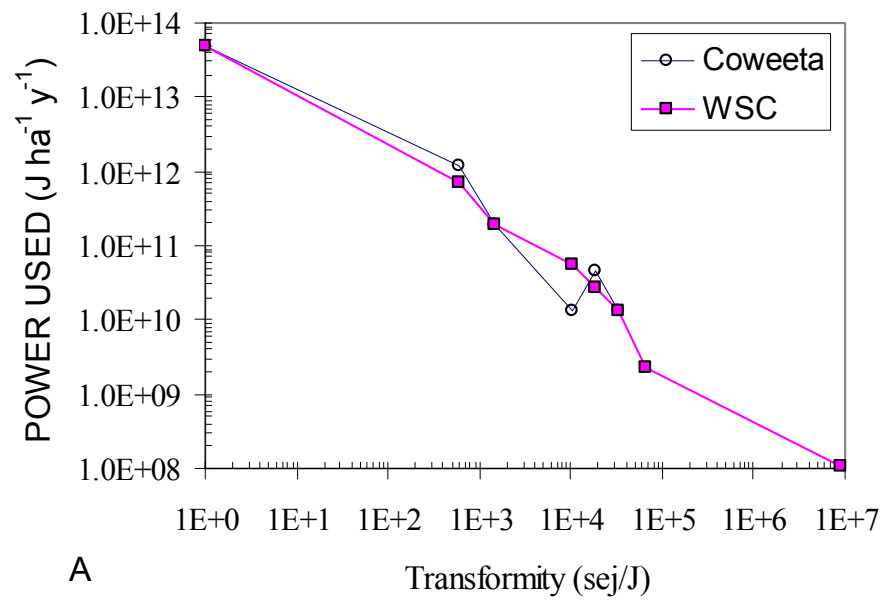

Fig. 3-3. Power (a) and empower (b) spectra of environmental energy inputs to Wine Spring Creek (squares) and Coweeta (circles) watersheds. S-sunlight, V-vapor saturation deficit, W-wind, RG-geopotential precipitation, ET-evapotranspiration, D-deepheat, F-fuels, H-human service. (see Tables 3-1 and 3-2 for details of calculations).

Figure 3-3b (empower spectrum) also revealed differences in the distribution of environmental energies used by the watersheds at Coweeta and WSC. Coweeta used more energy from the vapor saturation deficit and the chemical potential of transpiration, but less in the form of rain geopotential. The higher altitude of WSC (900 to 1600m v. 726 to 993m) likely contributed to the differences.

Imported Driving Energies

As shown in Figure 3-2, non-renewable, non-indigenous forms of energy (e.g., fuel, road construction material) were imported and matched with the locally 'free,' environmental energies to build and maintain an infrastructure (e.g., roads, scenic overlooks) within the WSC watershed. The infrastructure made it possible for the forest's resources to be utilized by scientists, local travelers, tourists, hunters, and loggers.

Table 3-2 shows the value of the energies imported to the WSC watershed. The watershed received over 15,000 visitors annually as part of the regional Southern Appalachian tourist attraction (Cordell et al. 1996). People used various energies, notably automotive fuel and their human services, to enjoy the recreational opportunities. In one year, visitors consumed 14 E12 sej/ha/y (12 Em\$/ha) of automobile fuel travelling around inside the WSC watershed. An additional 136 E12 sej/ha/y of auto-fuels were consumed by local through-traffic. Cordell et al. (1996) determined that the average length of stay for visitors was 19 hrs (an overnight stay). This represented about 200 people-hrs/ha, the equivalent of 768 E12 sej/ha/y assuming that the transformity of a recreating individual was equal to a typical U.S. citizen on an average day.

Table 3-2 also gives the values of the services imported to the WSC to extract timber, maintain the roads, manage the forest, and conduct science. The Forest Service,

over the last 25 yr was paid an average of \$9/ha/y by logging companies to harvest timber. This, combined with the fuels used in timber harvesting was valued at 14 E12 sej/ha/y. This was an order of magnitude less than the Forest Service expended (133 E12 sej/ha/y) to maintain thirty-two (32) km of roads--nine (9) km of paved road and twenty-three (23) km of unpaved service roads.

Table 3-2 shows that the largest imported source of emergy was the scientist participating in the WSC Ecosystem Demonstration Project (1377 E12 sej/ha/y).

Internal Processes

The internal processes of forest production, biogeochemical cycling, and maintenance of tree diversity were evaluated with emergy and are given next.

Forest production

Tables 3-1 and 3-2 list the elements of forest production evaluated and give the empower that operated them in the Coweeta (1306 E12 sej/ha/y) and WSC (982 sej/ha/y) watersheds, respectively. In each watershed, empower of forest production was the sum of transpiration, deep heat, and atmospheric deposition.

Tables 3-1 and 3-2 also provide the transformities for net primary production, root production, wood growth, litter fall, and leaf production for Coweeta and WSC watersheds. They ranged from 4.7 E3 sej/J for total net primary production in the WSC watershed to 2.1 E4 sej/J for wood accumulation in WS18 (Coweeta).

Biogeochemical cycles

Given in Table 3-3 are data for seven (7) sub-basins of the Coweeta watershed (#'s 2, 14, 18, 27, 32, 34, 36) used to calculate the empower of the weathering process and the emergy of weathered material. Figure 3-4 is a graph of select data from

Table 3-3. Empower and weathering rates for seven (7) sub-basins of Coweeta watershed.

WS #	Area, ha	Relative solar radiation	Precipitation, cm/y	Runoff, cm/y	Mid-elevation, m	Weathering rate, kg/ha/y	Sun Empower Density, sej/ha/y	Rain Empower Density, sej/ha/y	Geologic Empower Density, sej/ha/y	Altitude-specific empower per mass weathered, 1E9 sej/g	Total empower per mass weathered, 1E9 sej/g	Emergy per gram of water, 1E5 sej/g-H2O	Sediment discharge per water runoff, g/m ³
36	49	81	222	168	1282	779	4.1E+13	2.0E+15	1.5E+15	1.9	4.5	2.1	46.4
2	12	95	177	85	857	652	4.8E+13	1.6E+15	8.9E+14	1.4	3.8	2.9	76.7
34	33	90	201	118	1018	529	4.5E+13	1.8E+15	8.2E+14	1.5	5.0	2.2	44.8
18	13	50	194	103	860	482	2.5E+13	1.7E+15	6.6E+14	1.4	5.0	2.3	46.8
32	41	81	240	171	1078	328	4.1E+13	2.2E+15	5.3E+14	1.6	8.2	1.6	19.2
27	39	40	245	174	1258	325	2.0E+13	2.2E+15	6.1E+14	1.9	8.7	1.6	18.7
14	61	50	188	99	850	292	2.5E+13	1.7E+15	3.9E+14	1.4	7.2	2.1	29.4

Footnotes to Table 3-3

Area, precipitation, and runoff (Swank and Crossley, 1988)

Mid-elevation = (max. + min)/2 (max and min from Swank and Crossley, 1988)

Relative solar radiation: aspect scaled between 100 and 50. South=100; South-southeast=95, etc.

Weathering rate calculated from Velbel (1984)

Sun empower, sej/ha/y = (mean empower density, 50E12 sej/ha/y) x (relative radiation/100)

Rain empower, sej/ha/y = (precipitation, cm/y)/100 x (1E4 m²/ha) x (1E6 g/m³) x (9E4 sej/g)

Geologic empower, sej/ha/y = (weathering rate, kg/ha/y) x (altitude-specific emergy per gram, sej/g)

Altitude-specific empower per mass, sej/g: globally averaged empower per mountain erosion (see Table E-2)

Total empower per mass weathered, sej/g = (Rain empower + geologic empower, sej/ha/y) / (weathering rate, g/ha/y)

Emergy per gram of water, sej/g-H2O = Rain empower + geologic empower, sej/ha/y) / (water runoff, g-H2O/ha/y)

Sediment discharge per water runoff, g/m³ = (weathering rate, g/ha/y) / (water runoff, m³/ha/y)

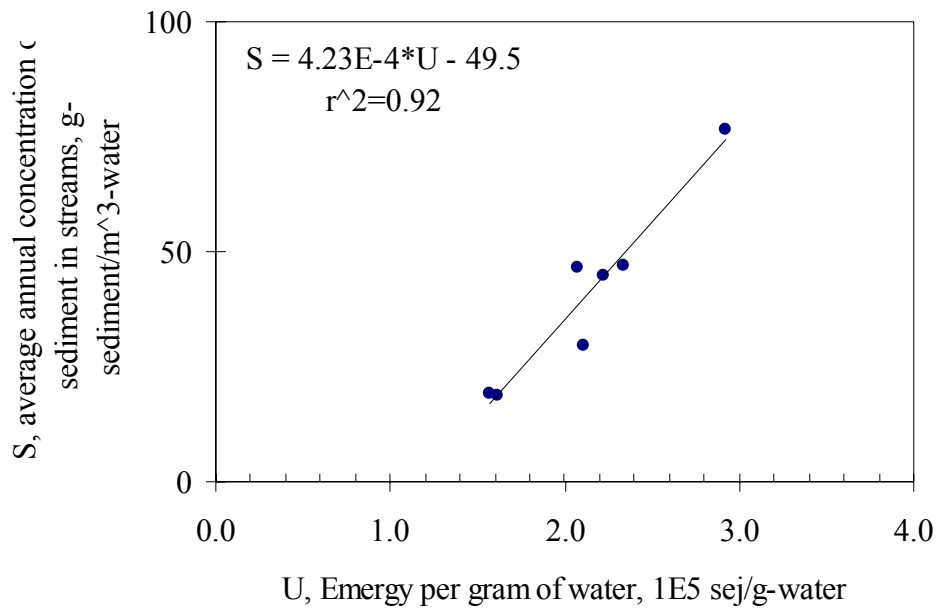

Figure 3-4. Concentration of suspended sediment in streams of the Coweeta basin as a function of energy (rain+geology) per gram of water.

Table 3-3. The graph shows that the concentration of sediment in stream waters increased as the emergy per mass of stream waters increased.

The total empower flux (rain + geologic uplift) per mass of rock weathered ranged from 3.8 E9 to 8.7 E9 sej/g for the seven (7) Coweeta sub-basins (Table 3-3, column 12).

Figure 3-5a shows an overview systems diagram highlighting the energy basis of the calcium cycle. Atmospheric deposition of calcium penetrates the soil solution, is used by vegetation, falls to the ground as litter, and is mineralized by soil processes. Acidic runoff waters percolate through the soil, down to the regolith, mineralizing the bedrock. Calcium ions from the mineralized bedrock and organic matter are placed in soil solution where the cycle begins again. Growth of forest biomass accelerates the mineralization process due to the addition of carbonic acid from soil respiration. Thus, the calcium cycle evolves over time, maturing with the forest.

Figure 3-5b shows that the three sources of calcium (wind, rain, and bedrock) provided 1.0, 3.8, and 18 kg-Ca/ha/y, respectively, to WS 18 of the Coweeta watershed. The rate of internal cycle, measured at plant uptake, was 82 kg-Ca/ha/y, ~3.5 times the annual input. The watershed exported 7 kg-Ca/ha/y. The internal reservoir of calcium, live vegetation (830 kg-Ca/ha) plus soil (620 kg-Ca/ha), had a residence time of ~63 y assuming a constant rate of influx.

Figure 3-5c shows the emergy budget of the calcium cycle of Coweeta. Calcium which entered the forest via dryfall and wetfall contributed, 1 E12 and 4 E12 sej/ha/y,

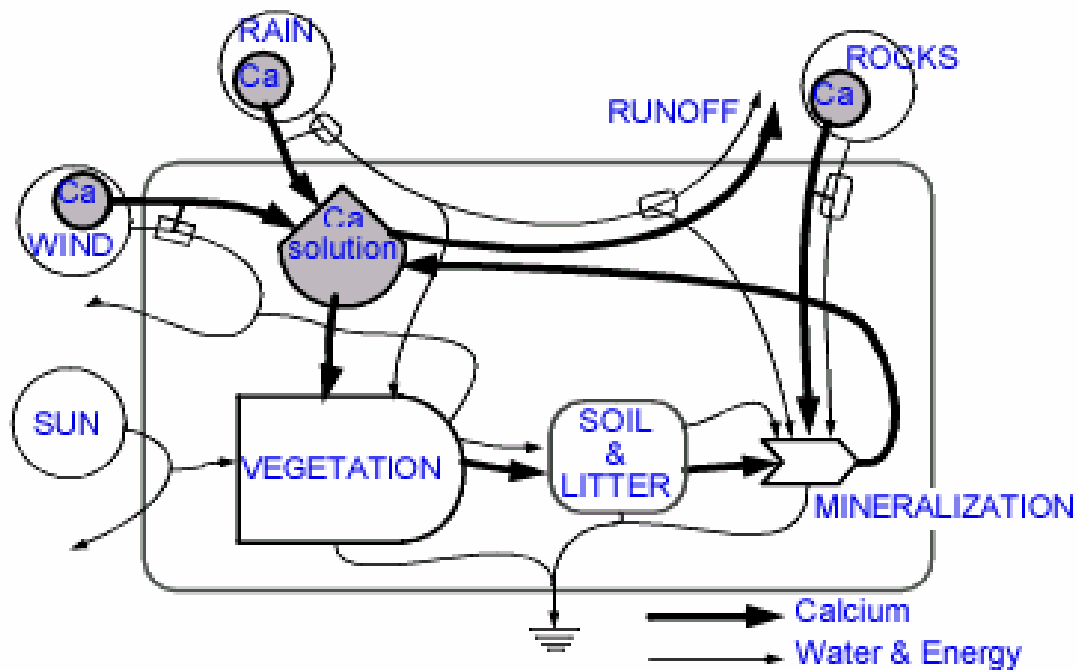

A. Energetics of Calcium cycle at Coweeta

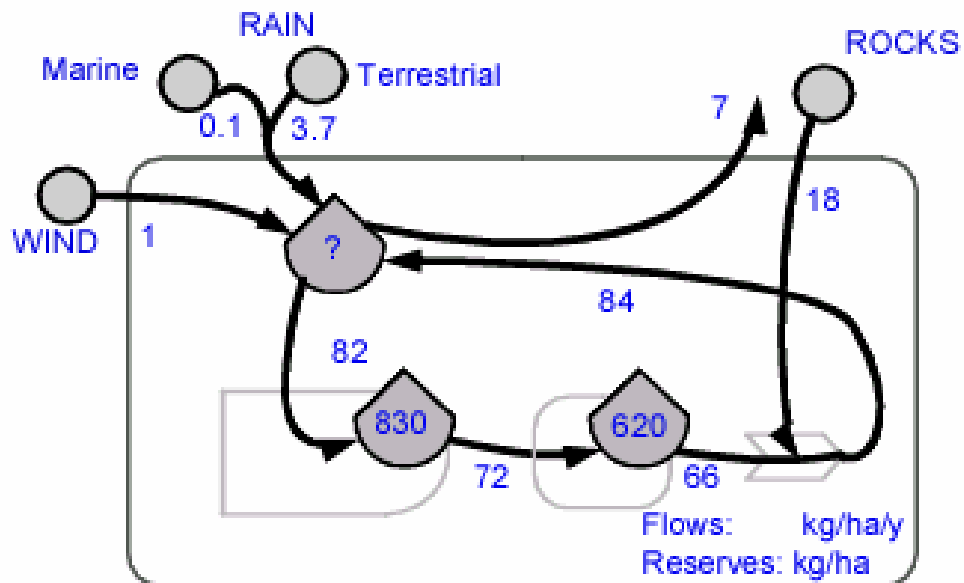

B. Calcium budget at Coweeta

Figure 3-5. Energy systems diagrams of the calcium cycle of WS18 at Coweeta watershed. A) driving energies and calcium kinetics, B) calcium budget, and C) energy of calcium inputs, internal cycle, and output.

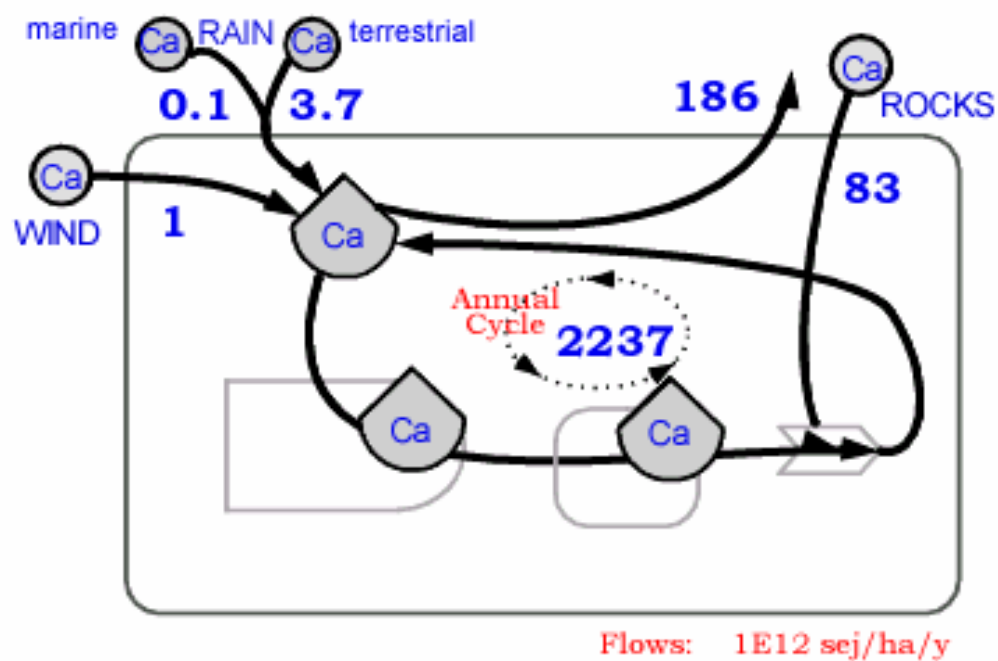

C. Emergy associated with calcium inputs,
internal cycle, and output.

Figure 3-5. continued.

respectively, to the forest. The 18 kg-Ca/ha/y that weathered from bedrock represented 83 E12 sej/ha/y.

Maintenance of tree diversity

Figure 3-6a shows the tree species-area curve for high-elevation forests of the WSC watershed. The species area curve was developed from unpublished data gathered by K. Elliot (USDA Coweeta Hydro Lab) in the WSC watershed at altitudes greater than 1200 m. The number of tree species increased with area, but at a decreasing rate. Thirty-two (32) tree species were found in total; twenty-nine (29) of which were found in the first hectare (10,000 m²).

Figure 3-6b shows the empower-species curve for the WSC forest which was developed by substituting annual empower for area. Approximately 2000×10^{12} sej/y supported thirty (30) tree species in the WSC forest, but a 50% increase in empower (1000×10^{12} sej/y) over this amount was needed to support thirty-two (32) tree species. Thus, the curve points out that to support another tree species, the additional amount of empower required is large.

Emergy of Forest Exports

Table 3-1 list the energy, emergy, and transformity of water, calcium, and minerals exported from the Coweeta watershed, while Table 3-2 lists the same information for the WSC watershed along with exports of recreated people, timber, and research information.

Shown in Tables 3-1 and 3-2, water yield from the Coweeta and WSC watersheds were on the order of 2250 E12 sej/ha/y.

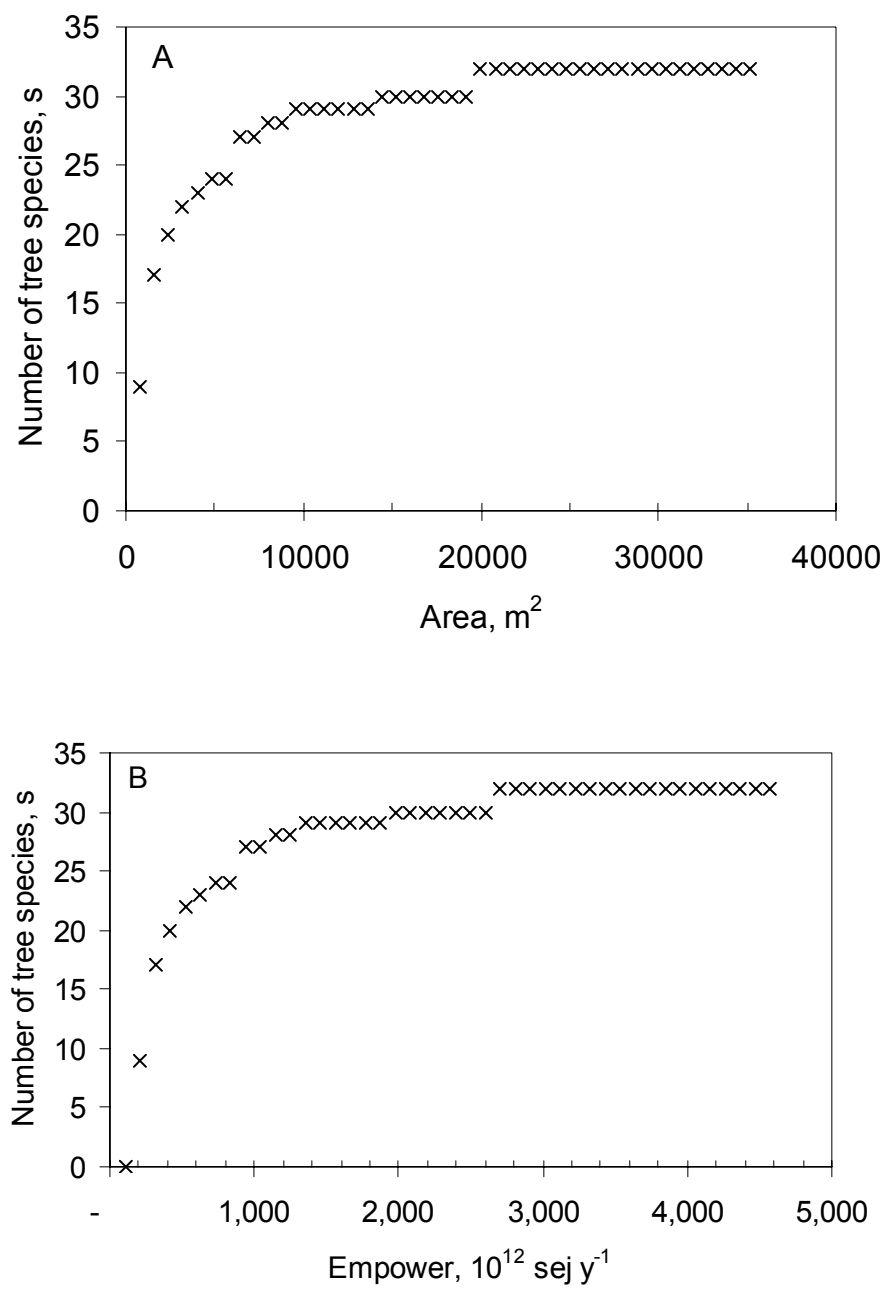

Figure 3-6. Tree species as a function of area (a) and as a function of annual empower (b) for high-elevation (>1200m) forest in the Wine Spring Creek watershed.

Table 3-1 shows that the calcium exported in stream water of the Coweeta watershed carried 186 E12 sej/ha/y. The total value of the minerals dissolved in the stream water was 926 E12 sej/ha/y. (Stream chemistry data were not available for the WSC watershed).

Table 3-2 shows that wood accumulation in the WSC forest was 982 E12 sej/ha/y, about eight (8) times the value of the harvest, excluding services (124 E12 sej/ha/y). With the services added, the wood harvest was valued at 291 E12 sej/ha/y.

Table 3-2 shows that the 15,000 people who visited the WSC watershed within a year (1995-96) enjoyed a total of 2065 E12 sej/ha/y. This was the sum of environmental and economic inputs. Environmental inputs were taken as half of the annual empower of rain, deep heat, and atmospheric deposition, since the watershed was only open to the public for half the year, from April to November. Economic inputs were the sum of fuel, human metabolism during their visit, road maintenance, and Forest Service empower.

The research effort put forth to study the WSC Ecosystem Management Project by the team of Forest Service and university scientists, Forest Service personnel, and graduate students represented 3790 E12 sej/ha/y (Table 3-2). Research publications were produced at the rate of 9.5 per year and their emergy value estimated at 450 E15 sej/publication (409,000 Em\$/pub).

Transformity of Forest Exports

Table 3-1 and 3-2 show the solar transformities calculated for the exports from the Coweeta (WS18) and WSC watersheds. Due to its higher elevation, the chemical and geopotential energy of water exported from the WSC watershed was higher than that exported from the Coweeta watershed. This led to the WSC having lower transformities. The water leaving WS18 (1 E10 g/ha/y) had a mean emergy per mass of 2.2 E5 sej/g-

water, while the water yield from WSC ($1.4 \text{ E}10 \text{ g/ha/y}$) was $1.6 \text{ E}5 \text{ sej/g}$. For comparison, global rainfall had an emergy per mass of $0.9 \text{ E}5 \text{ sej/g}$.

Whereas the mean transformity of all wood accumulation in the WSC was $1.6 \text{ E}4 \text{ sej/J}$, the harvested timber had a transformity 2 times greater ($3.0 \text{ E}4 \text{ sej/J}$; Table 3-2). The difference in transformity was due to the former being a flow and the latter a storage. That is, the transformity of wood accumulation was calculated as annual empower divided by annual growth and the transformity of harvested wood was emergy accumulated over its life span divided by its energy content.

The transformity of the tourists' metabolic energy, while visiting the watershed, was estimated to be $15 \text{ E}6 \text{ sej/J}$ (Table 3-2), about 70% greater than the $9 \text{ E}6 \text{ sej/J}$ for the average American (Odum 1996).

The transformity of the research publications was estimated to be $3.1 \text{ E}12 \text{ sej/J}$ (Table 3-2).

Dynamic Simulation of Emergy in Forest Storages

The natural wealth accumulated and stored as soil moisture, wood, total calcium, root biomass, total organic matter, saprolite, and tree species was evaluated for the forested watersheds using dynamic simulation. A simple product function that produced asymptotic growth to steady-state was used to estimate emergy stored as soil moisture, calcium, and root biomass. The two simulation models used for dynamic emergy accounting were EMERGYDYN and EMSPECIES. EMERGYDYN was used to simulate emergy of wood, total organic matter, and saprolite while EMSPECIES was used to simulate the emergy of tree species.

Table 3-4 summarizes the dynamic simulation of emergy in soil moisture, wood, root biomass, calcium, total organic matter, living vegetation, saprolite, and tree species.

Tree species were found to represent the largest storage of emergy that was measured (2,300,000 E15 sej/ha). Saprolite was two orders of magnitude less at 360,000 E15 sej/ha (330 million Em\$/ha). Emergy in total organic matter, calcium, and wood were 795 E15, 261 E15, and 169 E15 sej/ha, respectively. Water retained as soil moisture was 4 E15 sej/ha (4000 Em\$/ha).

Emergy of wood

Figure 3-7 is the systems diagram of EMERGYDYN showing the calibration values for the energy and emergy flows. Figure 3-8 is a graph of the simulated values for emergy and transformity of wood in the Coweeta watershed. EMERGYDYN simulated the emergy accumulated in wood as 169 E15 sej/ha by age 500 years, while the transformity of wood was 3.0 E4 sej/J.

Emergy of total organic matter

Figure 3-9 shows EMERGYDYN with values for energy, material, and emergy flows calibrated to simulate the total (live + dead) organic matter of WS 18. Calibration values for gross primary productivity (25 MT/ha/y), respiration (8 MT/ha/y), and export (2 MT/ha/y) were estimated based on the net primary productivity (15 MT/ha/y) measured in WS 18 by Day and Monk (1977) and on other values found for Southern Appalachian forests (Waide, 1988). Total empower input was the sum of rain ($100 \text{ E9 J/ha/y} \times 1.8 \text{ E4 sej/J} = 1800 \text{ E12 sej/ha/y}$) and deep heat ($14 \text{ E9 J/ha/y} \times 3.4 \text{ E4 sej/J} = 476 \text{ E12 sej/ha/y}$). Atmospheric deposition was excluded from the simulation models as a simplifying measure and since its contribution represented only 1% of total empower.

Table 3-4. Emergy evaluation of storages in one hectare of the forest at WS18 (Coweeta)

Item	Physical Units		Emergy per		Emdollar Value ^c Em\$/ha	Accumulation Period ^d (years)
			unit ^a (sej/unit)	Emergy ^b (E15 sej/ha)		
1 Soil moisture	8.5E+10	J	5.2E+04	4	4.0E+03	2
2 Wood	5.7E+12	J	3.0E+04	169	1.5E+05	80
3 Total organic matter	3.2E+13	J	2.5E+04	795	7.2E+05	200
4 Calcium reserve	1.5E+06	g	1.8E+11	261	2.4E+05	200
5 Sub-soil (saprolite)	9.2E+10	g	7.9E+09	725,000	6.6E+08	161005
6 Tree species	0.062	species	3.7E+22	2,300,000	2.1E+09	

Equations:

^a Transformity (sej/J) = emergy stored divided by energy

^a Emergy-to-mass ratio (sej/g) = emergy stored divided by energy (or mass) available.

^a Emergy per species (sej/unit) = emergy stored divided by species.

^b see individual footnotes in Appendix A.

^c Emdollar value = emergy divided by North Carolina emergy-to-dollar ratio (ca. 1992)

Footnotes to Table 3-4 in Appendix A

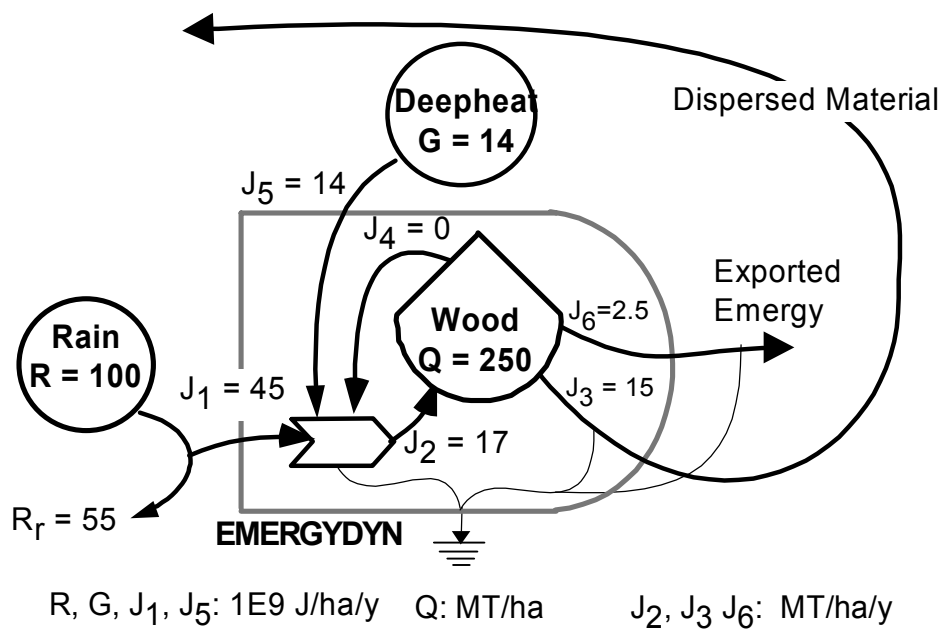

a) Energy and material flows

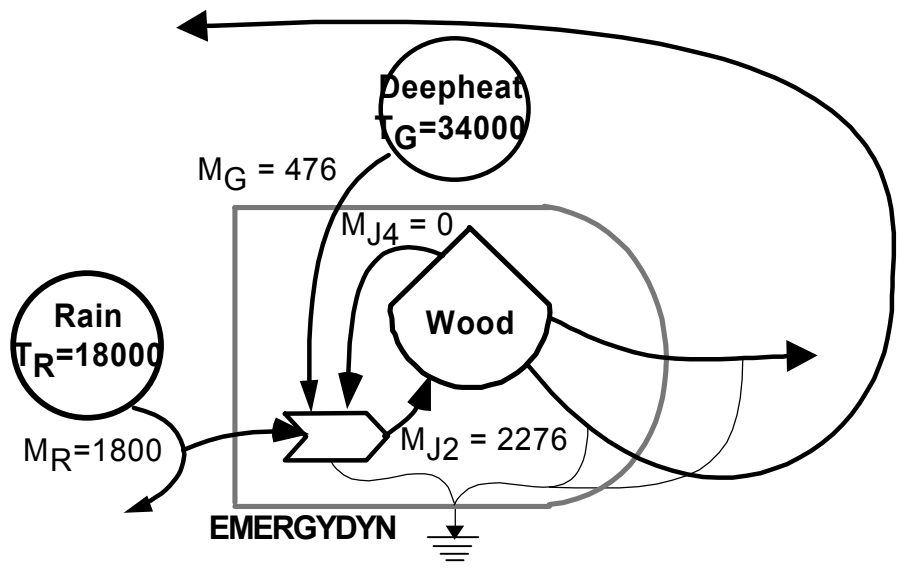

Transformity of rain & deepheat, T_R & T_G : sej/J
 Empower used from rain & deep heat, M_{J1} & M_{J5} : 1E12 sej/ha/y

b) transformity and empower of sources

Figure 3-7. Energy systems diagrams of EMERGYDYN used to simulate dynamics of energy accumulation for wood biomass of the Coweeta watershed. Calibration of energy and material flows (a) and empower sources (b).

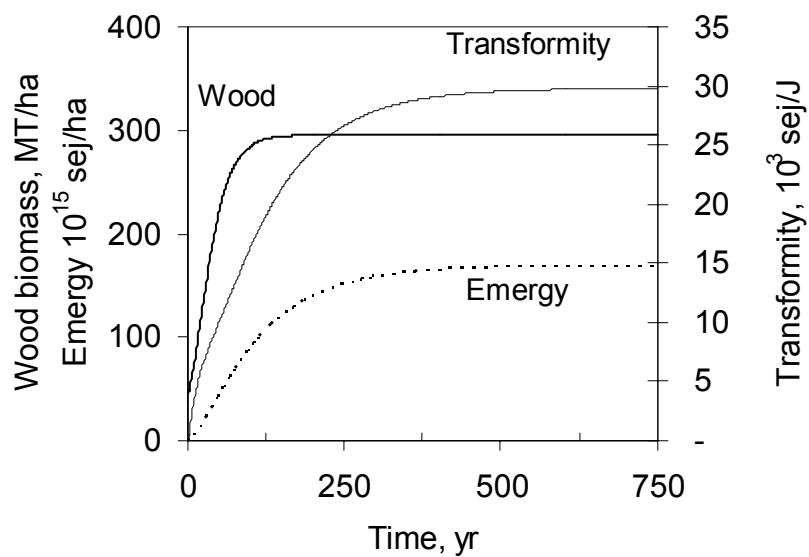
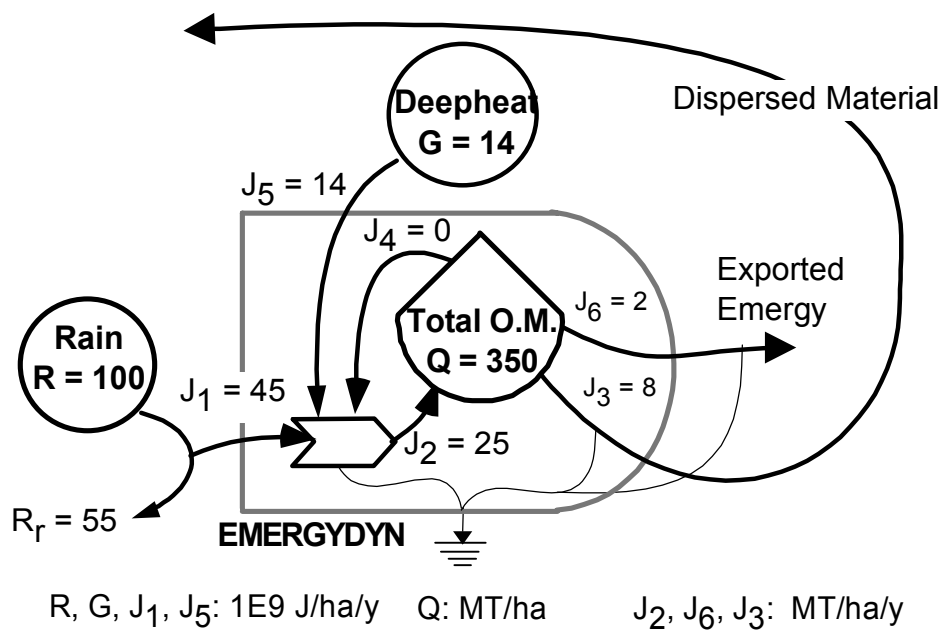
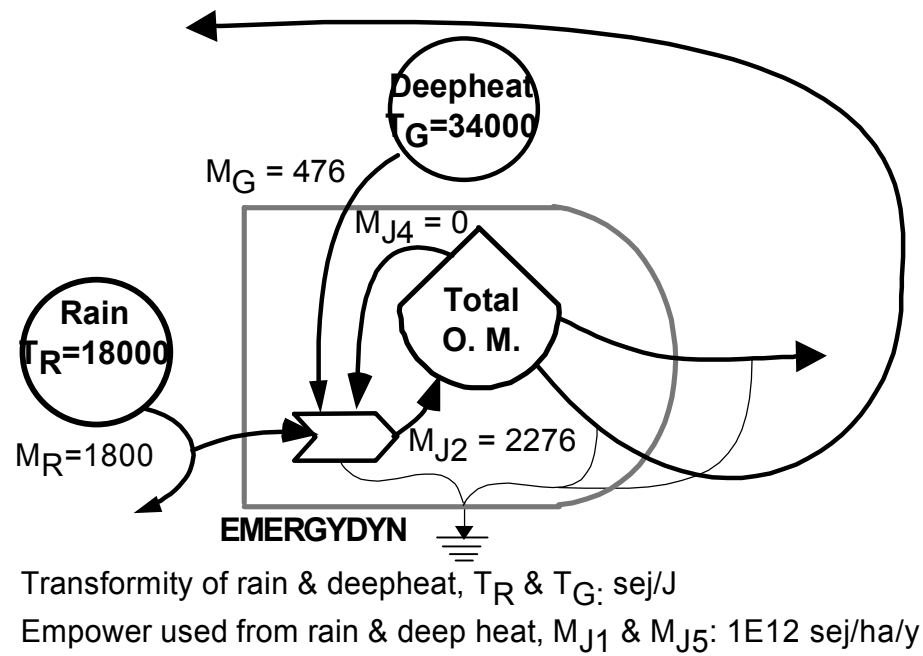

Figure 3-8. Simulation results of EMERGYDYN calibrated in Figure 3-7 for wood biomass of Coweeta. Time series of wood biomass, energy of wood biomass, and transformity of wood biomass are shown.



a) Energy and material flows



b) transformity and empower of sources

Figure 3-9. Energy systems diagrams of EMERGYDYN used to simulate dynamics of energy accumulation for total (live + dead) organic matter of the Coweeta watershed. Calibration of energy and material flows (a) and transformity and empower sources (b).

These estimates of empower were each about 3% greater than the values given in the energy evaluation table of Coweeta (Table 3-1) due to rounding.

Figure 3-10 presents simulation output for total organic matter. Gross primary productivity (GPP) was within 10% of its maximum value by year 100 and respiration lagged GPP by about 75 years. Net production peaked at year 50, and decreased asymptotically to zero (Figure 3-10a).

Figure 3-10b shows empower and transformity of process rates for total organic matter. Empower used was at its maximum by the 200th year, but the empower export rate did not equal the input until year 750. The transformity of organic matter that was exported increased over time, reaching its maximum value of 11,000 sej/J by the 600th year.

Shown in Figure 3-10c are the simulated values for the energy and total organic matter stored. Although the physical quantity of organic matter required about 250 years to reach its maximum value (~1600 MT/ha), its transformity increased at a slower rate, requiring 500+ years to level-off at 11,300 sej/J. By year 750, the value of the total organic matter stored was 400 E15 sej/ha (360,000 Em\$/ha).

Emergy of saprolite (regolith)

EMERGYDYN was calibrated to simulate the emergy dynamics of saprolite formation in the Coweeta watershed (Figure 3-11). Formation and storage of saprolite was a function of the energy inputs of rain and deep heat, export, and dispersion. The two (2) meters of rainfall (equivalent to 100 E9 J/ha/y as chemical potential) and deep heat (14 E 9 J/ha/y) were the driving energies for saprolite production. The 91.5 E9 g/ha of saprolite was assumed to be in steady state with the production rate calibrated to equal

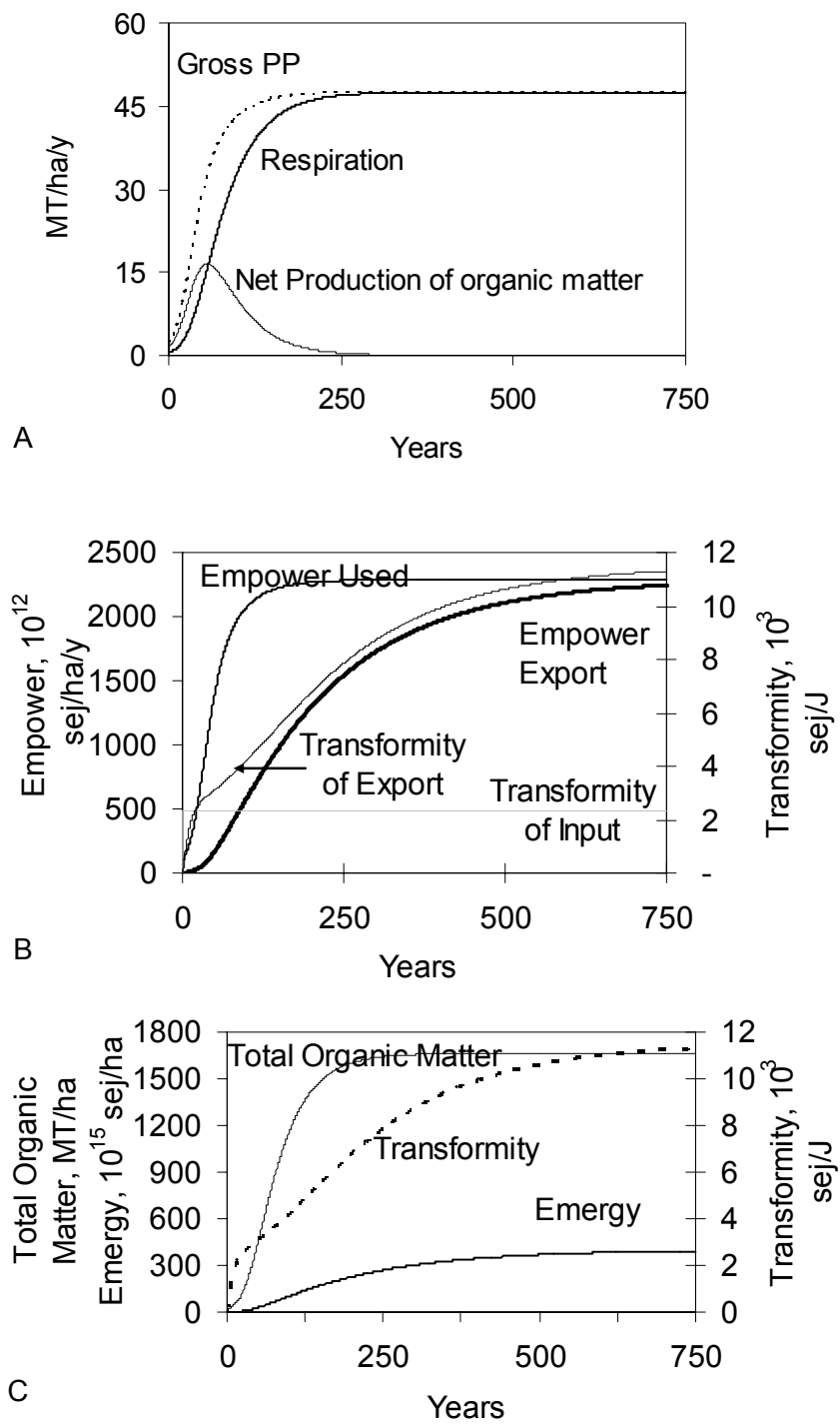
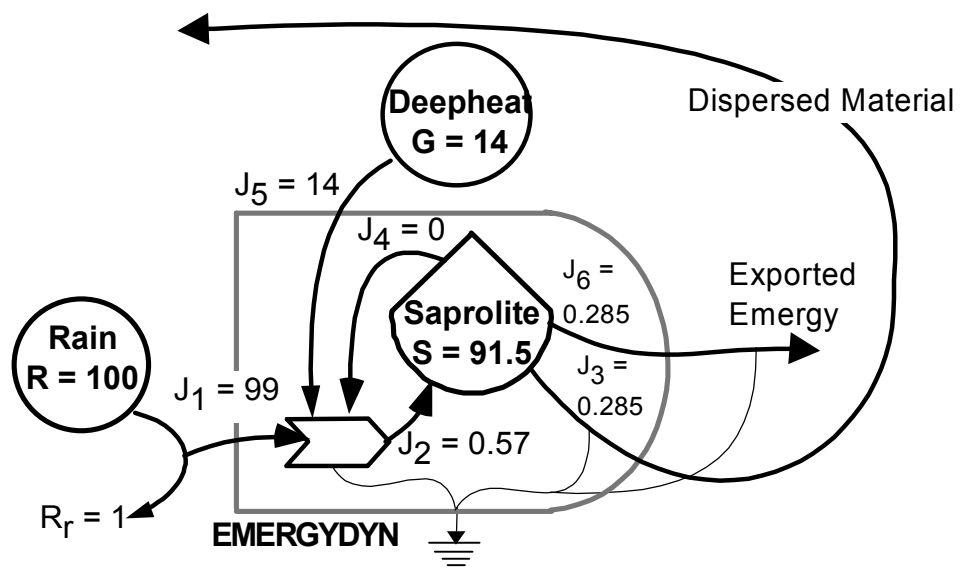
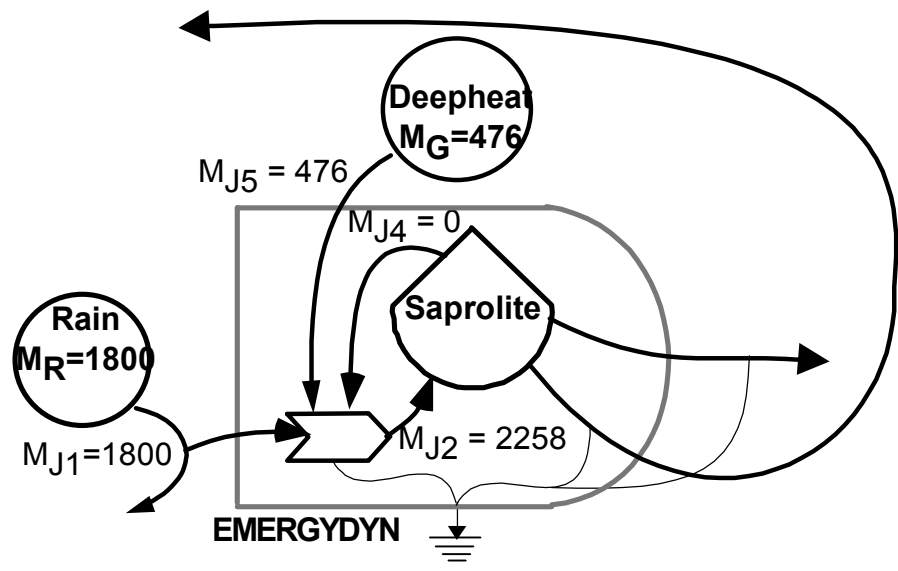

Figure 3-10. Simulation results of EMERGYDYN calibrated in Figure 3-9 for total organic matter of Coweeta. Gross production, respiration, and net production (a), empower and transformity of use and export (b), and transformity and emergy of storage (c) are shown.



R, G, J_1 , J_5 : $1E9$ J/ha/y S: $1E9$ g/ha J_2 , J_6 , J_3 : $1E6$ g/ha/y

a) Energy and material flows



Empower of x, M_x : $1E12$ sej/ha/y

b) empower input

Figure 3-11. Energy systems diagrams of EMERGYDYN used to simulate dynamics of energy accumulation for saprolite of the Coweeta watershed. Calibration of energy and material flows (a) and empower sources (b).

total loss ($0.57 \text{ E}6 \text{ g/ha/y}$). As a first approximation, total loss of saprolite was split evenly between dispersion and export (i.e., each equaled $0.285 \text{ E}6 \text{ g/ha/y}$).

The calibration value for the empower input from rain ($1800 \text{ E}12 \text{ sej/ha/y}$) was energy input multiplied by $1.8 \text{ E}4 \text{ sej/J}$. Similarly, deep heat empower ($476 \text{ E}12 \text{ sej/ha/y}$) was energy flow times $3.4 \text{ E}4 \text{ sej/J}$ (Figure 3-11b).

Figure 3-12 shows simulation of emergy of saprolite formation. Beginning with essentially bare rock and nearly no saprolite, the present day amount of saprolite ($91.5 \text{ E}9 \text{ g/ha}$) required 500,000 years to form. The emergy per mass of saprolite increased over time and reached its maximum ($8 \text{ E}9 \text{ sej/g}$) at year $1.5 \text{ E}6$. At the same time, the emergy accumulated in the saprolite leveled off at $715 \text{ E}18 \text{ sej/ha}$ ($650 \text{ E}6 \text{ Em\$/ha}$).

Emergy of tree diversity

Figure 3-13a shows the model EMSPECIES with its mathematical equations. The model was used to simulate the emergy of tree diversity. Figure 3-13b shows the close correlation between the modeled and observed species area curves for the WSC watershed.

The graph in Figure 3-13c is the emergy accumulated in tree species of WSC watershed at elevations above 1200 m as a function of area. The graph is the simulated result of the model EMSPECIES shown in Figure 3-13a. In Figure 3-13c it can be seen that within an area of $3.5 \text{ E}4 \text{ m}^2$, the emergy accumulated as tree species was $13 \text{ E}22 \text{ sej}$ ($120 \text{ E}9 \text{ Em\$/ha}$).

Spatial gradients of emergy and empower in mountain watersheds

The spatial dynamics of emergy empower, and transformity were evaluated for the mountain watershed and are presented in this section.

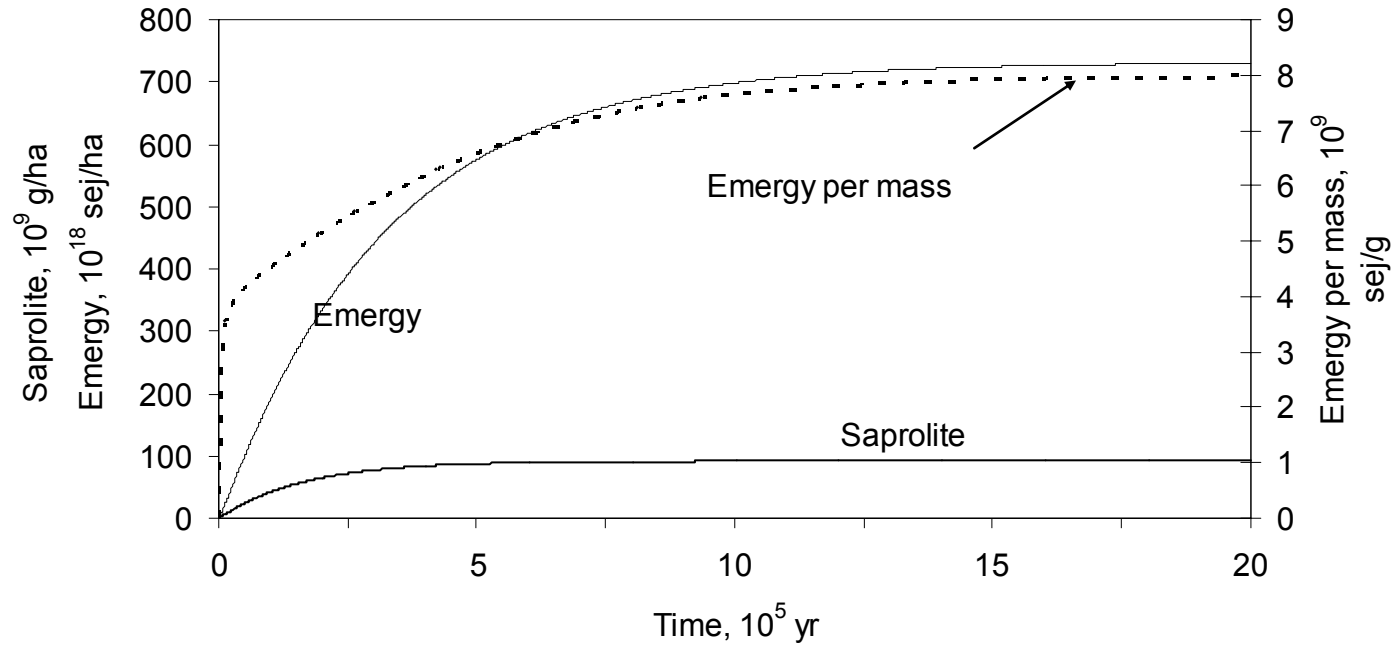
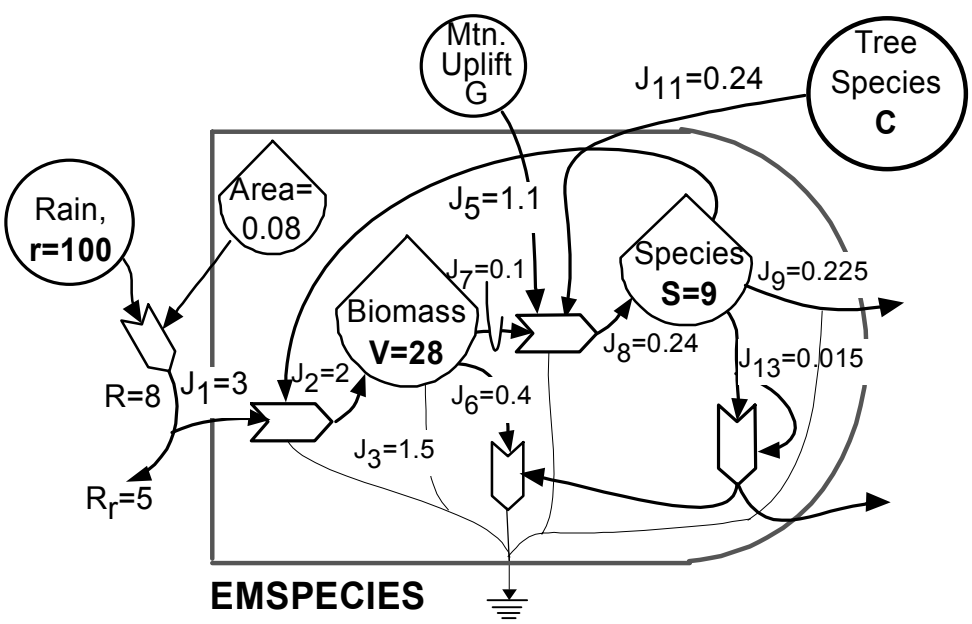

Figure 3-12. Simulation results of EMERGYDYN calibrated in Figure 3-11 for saprolite (regolith) at Coweeta. Energy, energy per mass of saprolite, and quantity of saprolite are shown.



Units:
 Area--ha; biomass(V)--MT; species(S)--number of trees species;
 rain(r)-- $1E9$ J/ha/y; uplift(G)-- $1E9$ J/ha/y; new species(C)--trees.
 J_1, J_2, J_3, J_6, J_7 -- $1E9$ J per 0.08 ha per y;
 J_8, J_9, J_{11}, J_{13} --tree species per 0.08 ha per y.

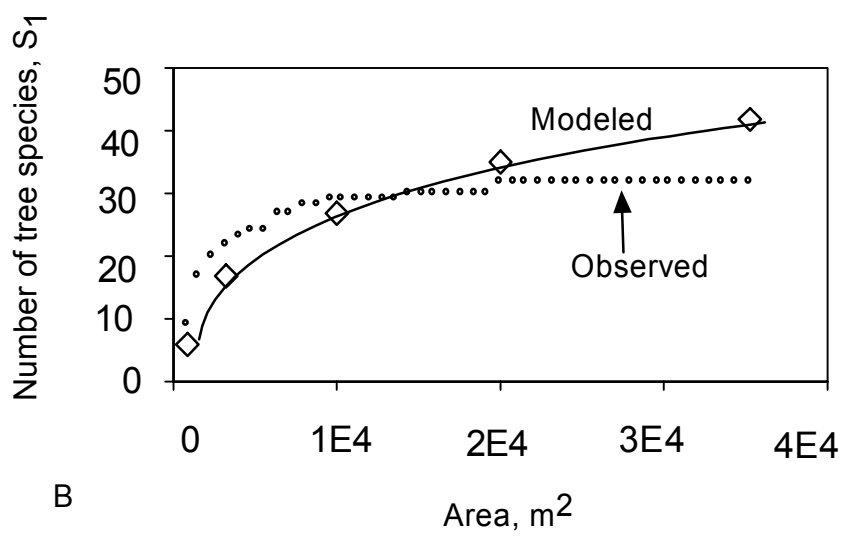

Figure 3-13. Model EMSPECIES used to calculate tree species abundance and energy stored as tree species for the Wine Spring Cree watershed. A) systems diagram of model EMSPECIES shown with calibration values for an area of 0.08 ha, B) tree species-area curves for elevations above 1200m: simulation results compared to observations made by K. Elliott (unpublished data, Coweeta Hydro. Lab.), and C) simulated energy stored per tree species for elevations above 1200m.

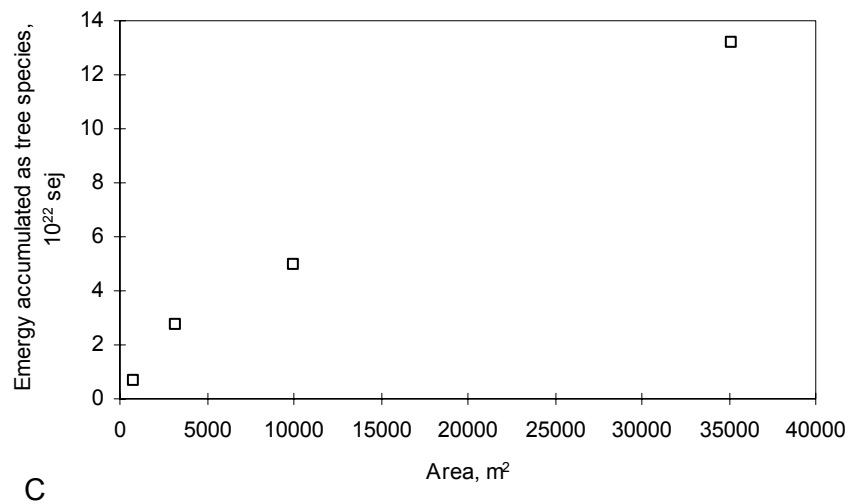

Figure 3-13. continued.

Spatial gradients of empower input

Figure 3-14a is a systems diagram that explains how the spatial configuration of stream empower was calculated. Figure 3-14b is a map showing the spatial distribution of empower input across the mountain surface. Incoming empower density was greatest at the mountain peaks and decreased with elevation. Even though forest productivity has generally been found to be less at higher elevations (Odum 1970, Doherty et al. 1997), this map shows that the quality of the productivity may be greater since the empower density is greater. Figure 3-14c is a map of the stream empower showing the increase in empower downstream. First order streams carried in the range of $1 \text{ E}16$ to $1 \text{ E}17$ sej/y, while second order streams had from $1 \text{ E}17$ to $1 \text{ E}18$ sej/y, and the main segment of the Wine Spring Creek was carrying $5 \text{ E}18$ sej/y at the watershed outlet.

Figure 3-15 shows the areal distribution of the total empower density for the WSC watershed which was determined from the combination of the input empower and stream empower maps shown in Figures 3-14b and 3-14c. The distribution had a mode of $4500 \text{ E}12$ sej/ha/y with about 300 ha having this value. Ninety-eight percent (98%) of the watershed had an empower density less than $1 \text{ E}16$ sej/ha/y. The greatest empower density ($4 \text{ E}18$ sej/ha/y) at the mouth of the watershed represented a very small amount of the watershed.

Spatial distribution of soil organic matter

Table 3-6 shows estimates of soil organic matter for the WSC watershed by soil type. The mean organic content of WSC soil was 232 MT ha^{-1} . As shown in column 2 of Table 3-6, the floodplain soil Cullasaja, at 565 MT-O.M./ha , had more than twice the organic matter of any other soil type. However, by virtue of its limited coverage in the

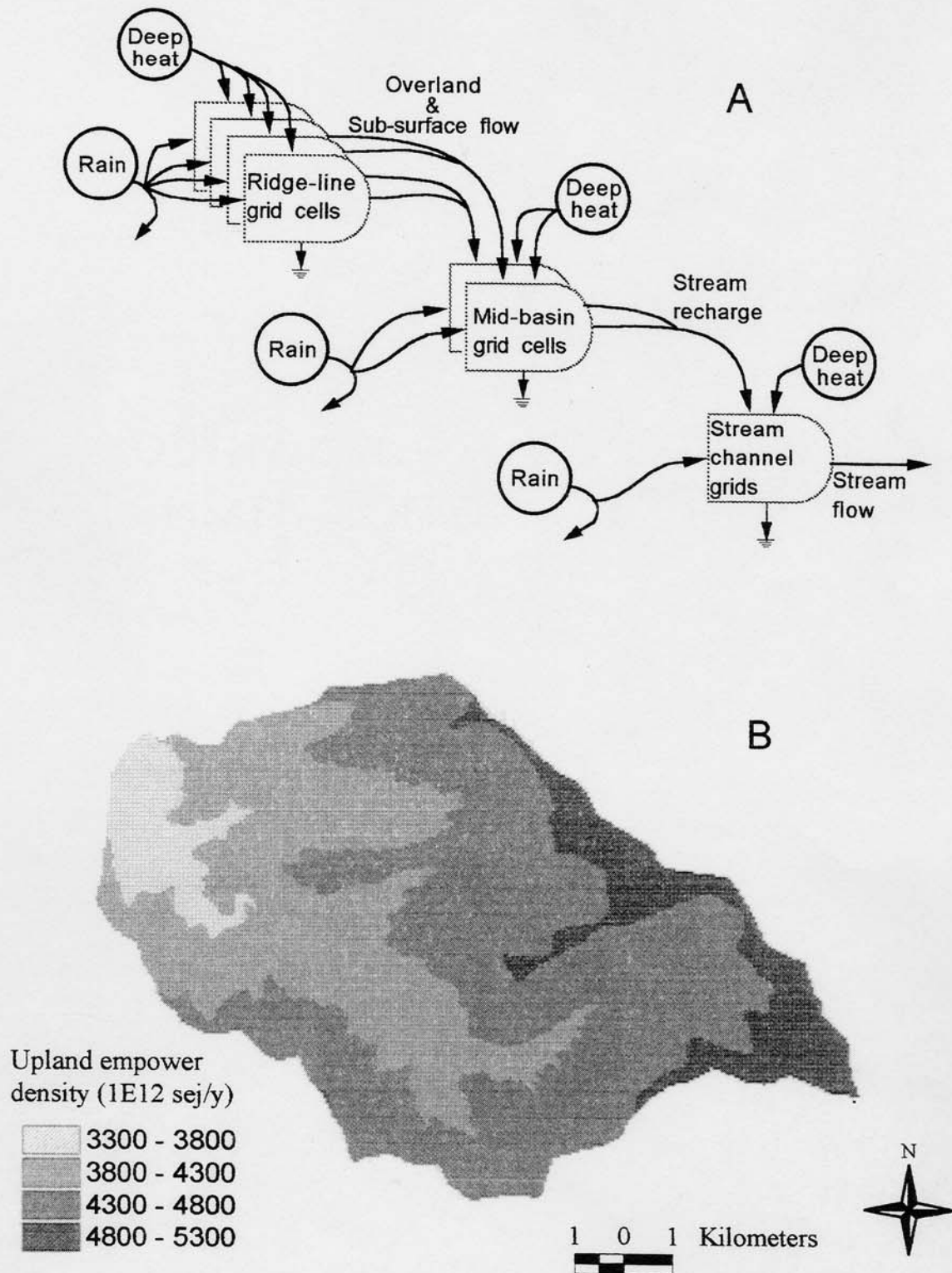

Figure 3-14. Empower of streams in the Wine Spring Creek watershed. A) systems diagram demonstrating how upstream empower from rain and deep heat converge from the ridge line down through the mid-basin region into the stream channel. B) map of upland empower density, C) map of stream empower.

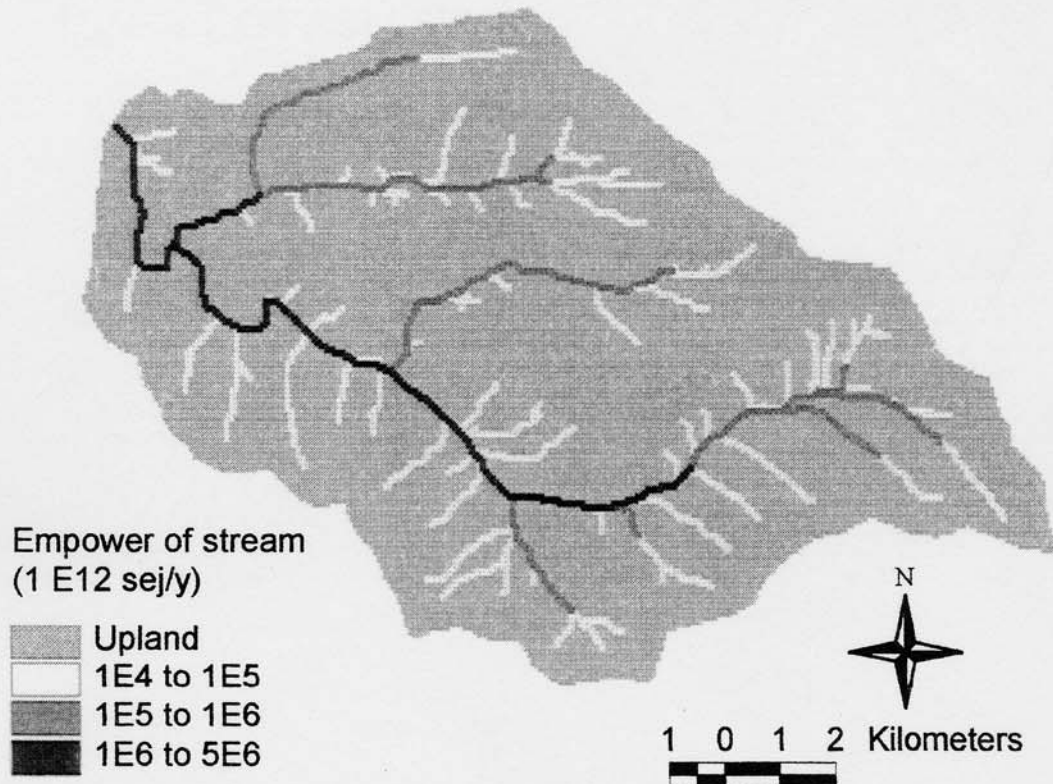

Figure 3-14. continued.

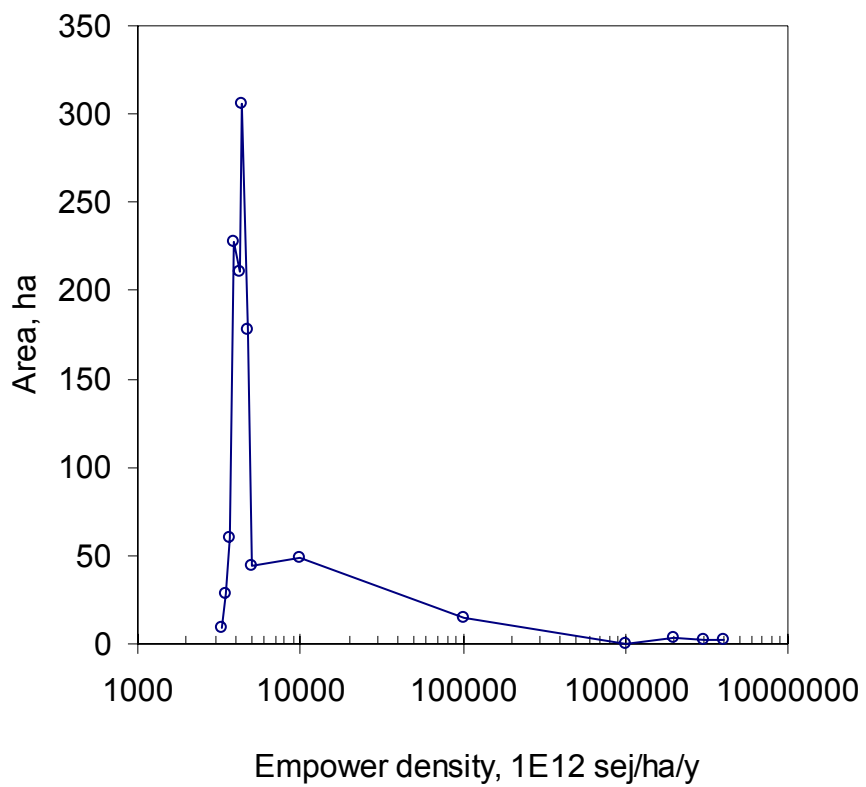

Figure 3-15. Areal distribution of environmental empower density in the 1128 ha Wine Spring Creek watershed.

Table 3-6. Soil organic matter in WSC watershed by soil type.

Soil Type	Mean soil organic matter, MT/ha	Mean elevation, m	Area, ha	Total soil organic matter, MT
Cullasaja	565	1315	129	72610
Plott	269	1382	349	93984
Tuckasegee-Cullasaja	231	1208	14	3216
Tuckasegee-Whiteside	231	1258	6	1448
Wayah	229	1523	51	11743
Cheoh	202	1207	126	25419
Edneyville-Chestnut	116	1351	259	30038
Chestnut	90	1454	2	147
Spivey-Santeetlah	89	1085	52	4589
Soco-Stecoah	87	1195	71	6176
Porter	72	1068	27	1949
Total			1085	251318
Mean	232			

Footnotes to Table 3-6

Mean soil organic matter, MT/ha = mean soil depth x mean bulk density x mean organic fraction

Mean elevation of soil type from GIS coverages of topography and soils.

watershed, it only represented the second largest storage of soil organic matter (72.6 E3 MT). The Plott series, which generally has a north facing slope contained the greatest amount of soil organic matter.

Figure 3-17 graphs average organic matter per soil type as a function of the average elevation of the soil type. The elevation gradient was 275 MT-O.M./ha per km of elevation. Translating the soil organic matter to emergy based on a transformity calculated for the Coweeta soil organic matter (9.3 E4 sej/J), an emergy gradient of 482 E12 sej/ha m⁻¹ resulted.

Figure 3-18 shows the spatial distribution of soil organic matter classified by soil type. Generally, north-facing slopes had soils with high organic matter content (116-270 MT-O.M./ha), although, the floodplain soil, Cullasaja, had the highest organic content.

Emergy Evaluation of Forest Economies

The emergy basis of the state of North Carolina (~1x10⁷ ha) and one of its counties, Macon (~1x10⁵ ha), was appraised to ascertain the prominence of forested ecosystems in linking environmental energies to the economic system of people. Macon County was chosen because it contained the two forested watersheds evaluated in this study. Emergy evaluations of the U.S. forestry industry were undertaken to determine how much wealth was contributed from forest ecosystems to economic systems. Lumber, plywood, pulp, and paper were included in the analysis. International trade in forest products between the U.S., Canada, and Mexico in the wake of passage of the North American Free Trade Agreement (NAFTA) was evaluated. Finally, empower consumed from the world's forests since 1950 was determined.

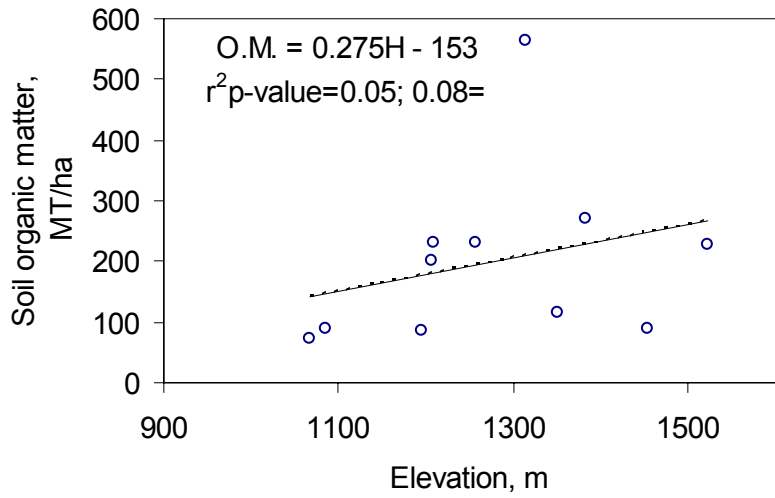

Figure 3-17. Elevation gradient of soil organic matter in Wine Spring Creek watershed. Average organic matter per soil type as a function of mean elevation of soil type.

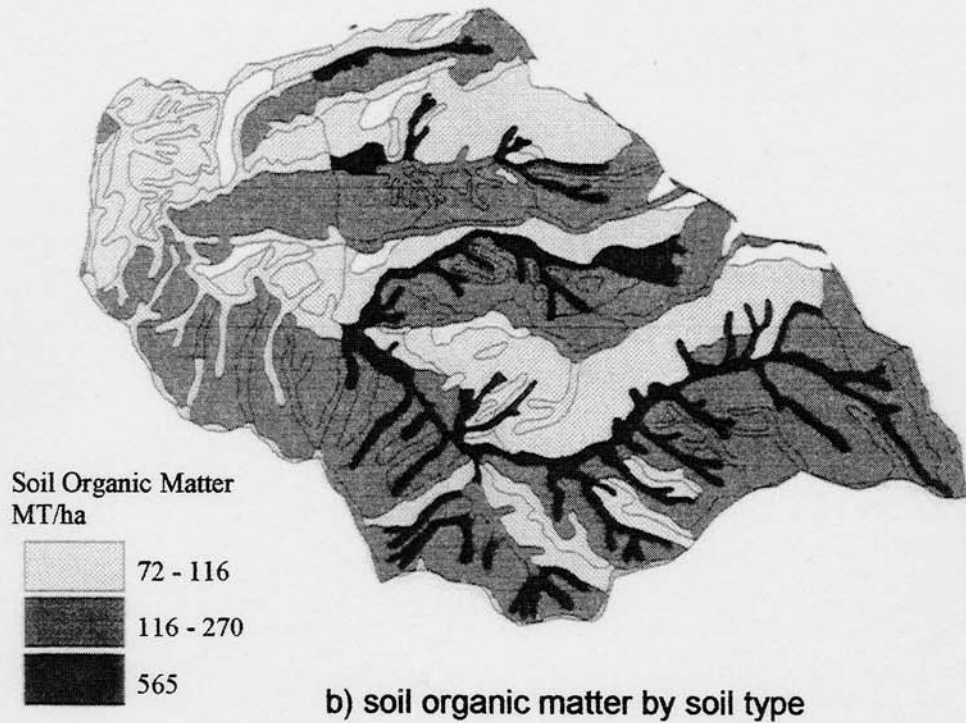
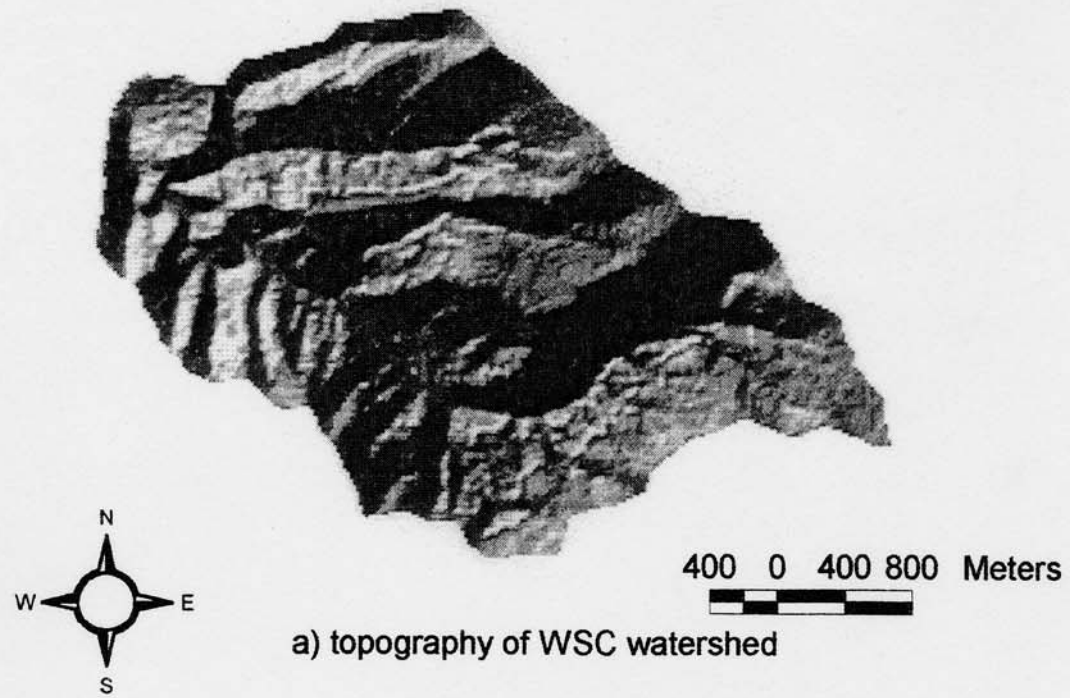

Figure 3-18. Topographic coverage of WSC watershed (a) and spatial distribution of soil organic matter by soil type (b).

Macon County, N.C.

The systems diagram of Macon County (Figure 3-19) highlighted the fundamental relationship that existed between forest ecosystems, mountains, and economy. Covering, 84% of the county land surface, forested ecosystems transformed the dilute, low transformity energies of sun, vapor deficit, wind, water, and geologic uplift into ecological commodities. Rainfall in the county, above the state average, was aided by the mountain system. These two main features of the landscape, forests and mountains, together provided the environmental basis for much of the county's economic activities.

The county was chosen for analysis because it is home to both the Coweeta and WSC watersheds (see Figure 1-1). It also is a county representative of the Southern Appalachian Mountains.

Environmental driving energies of Macon County

As can be seen in Table 3-7, of the renewable energy sources used within the county, deep heat ($0.63 \text{ E}20 \text{ sej/y}$; $32 \text{ E}6 \text{ Em\$/y}$) was the largest. The use of rain chemical potential in transpiration ($0.48 \text{ E}20 \text{ sej/y}$), the use of rain geopotential ($0.46 \text{ E}20 \text{ sej/y}$), depression of the vapor saturation deficit ($0.42 \text{ E}20 \text{ sej/y}$), and wind ($0.38 \text{ E}20 \text{ sej/y}$) were not much less.

Table 3-7 also shows the emergy values of the indigenous renewable energies used in Macon. These were ecosystem products made by the interaction of the environmental and imported driving energies. Of the three economic sectors linked directly to the environment (i.e., electrical power supply, agriculture, and forestry), hydro-electricity production ($1.41 \text{ E}20 \text{ sej/y}$) offered the most empower. Agriculture was second with $1.31 \text{ E}20 \text{ sej/y}$ and forestry was third, harvesting $0.60 \text{ E}20 \text{ sej/y}$.

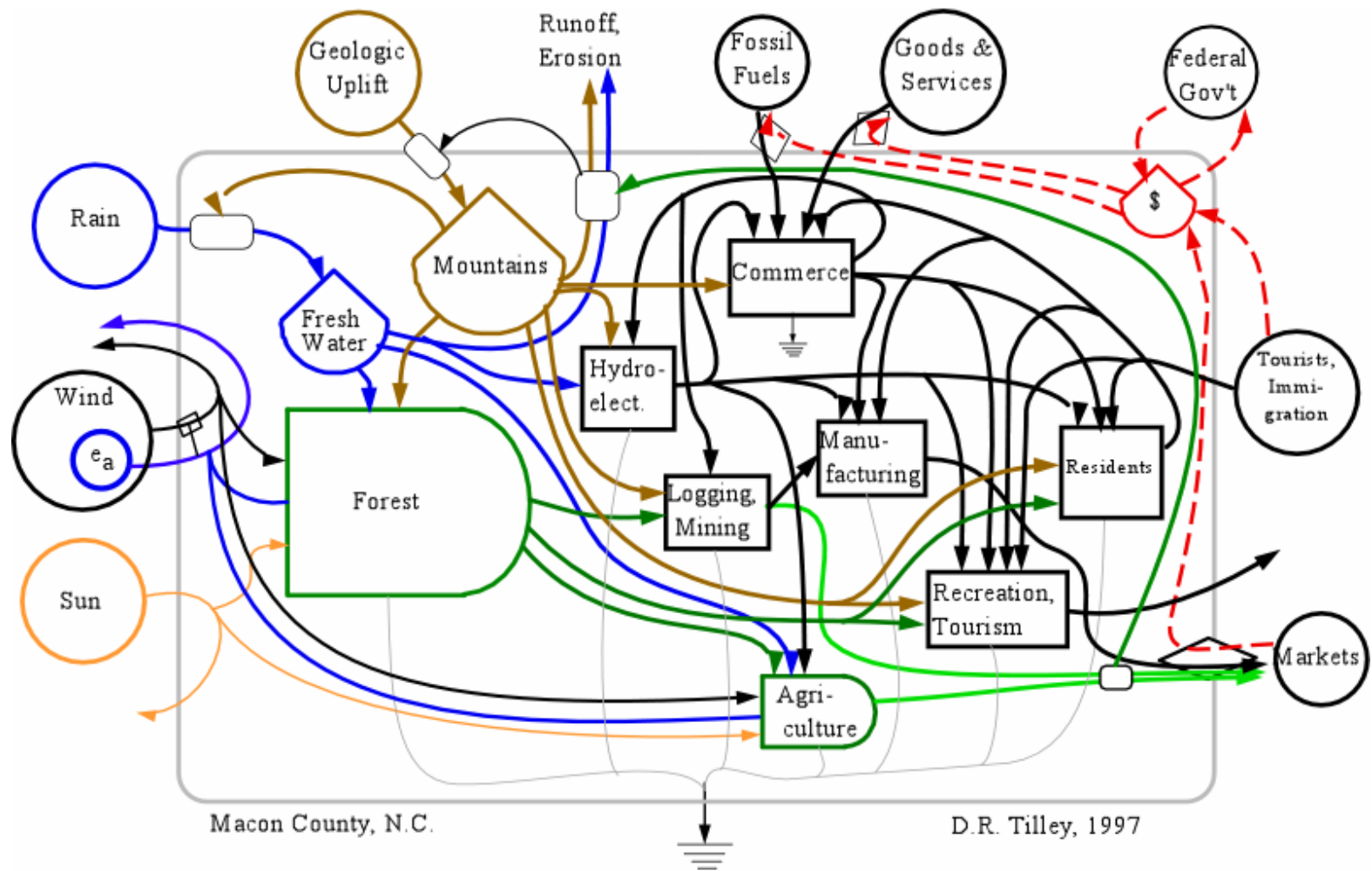

Figure 3-19. Systems diagram of Macon county, N.C. (1992).

Table 3-7. Emergy evaluation of resource basis of Macon Co., N.C. ca. 1992.

Note	Item	Physical Units	Trans- formity (sej/unit)	Solar Emergy (E18 sej)	Value to Macon County Economy (1E6 Em\$, 1992)
RENEWABLE RESOURCES:					
1	Sunlight	7.18E+18 J	1	7.2	3.3
2	Rain (transpired)	5.96E+15 J	1.8E+04	108.4	49.3
3	Rain, geopotential	2.01E+15 J	1.1E+04	21.1	9.6
4	Wind, kinetic	2.56E+16 J	1.5E+03	38.3	17.4
5	Saturation deficit	1.61E+17 J	5.9E+02	94.8	43.1
6	Historic erosional loss	2.01E+10 g	1.0E+09	20.1	9.1
7	Geologic Uplift	6.42E+14 J	3.4E+04	21.8	9.9
8	Deep heat	1.82E+15 J	3.4E+04	62.0	28.2
INDIGENOUS RENEWABLE ENERGY:					
9	Hydroelectricity	8.85E+14 J	1.6E+05	140.7	64.0
10	Total electricity use	1.41E+15 J	1.6E+05	223.8	101.8
11	Agriculture prod	3.86E+14 J	2.0E+05	77.2	35.1
12	Livestock prod	2.70E+13 J	2.0E+06	53.9	24.5
13	Forest growth	4.25E+15 J	2.1E+04	89.1	40.5
14	Forest extraction	1.47E+15 J	4.1E+04	60.1	27.4
15	Fuelwood use	2.87E+14 J	4.1E+04	11.8	5.4
NONRENEWABLE SOURCES FROM WITHIN SYSTEM:					
16	Present erosional loss	1.07E+11 g	1.0E+09	107.2	48.8
17	Gemstones	50,000 \$	1.5E+12	0.1	0.0
18	Non-fuel minerals	3.52E+11 g	5.0E+08	175.8	79.9
IMPORTS AND OUTSIDE SOURCES:					
19	Petroleum Prods.	1.96E+15 J	6.6E+04	129.6	58.9
20	Natural Gas	- J	4.8E+04	0.0	0.0
21	Coal	- J	4.0E+04	0.0	0.0
22	Electricity	5.22E+14 J	1.6E+05	83.1	37.8
23	Livestock	- J	2.0E+06	0.0	0.0
24	Net Immigration	1.92E+12 J	2.5E+07	47.3	21.5
25	Machinery, Equipment	3.00E+09 g	6.7E+09	20.1	9.1
26	Wood	- J	1.7E+04	0.0	0.0
27	Fed. Government	3.87E+07 \$	1.5E+12	58.1	26.4
28	Imports, non-tourism	2.58E+07 \$	1.5E+12	38.7	17.6
29	Tourist (time)	1.11E+13 J	2.5E+07	274.0	124.6
30	Tourist services	3.26E+07 \$	1.5E+12	48.9	22.2
EXPORTS:					
31	Tobacco	8.79E+11 J	1.5E+06	1.4	0.6
32	Wood/wood prod	5.08E+14 J	1.7E+04	8.7	4.0
33	Livestock	6.69E+12 J	2.0E+06	13.4	6.1
34	Minerals	2.75E+11 g	5.0E+08	137.6	62.6
35	Service in exports	2.58E+07 \$	1.5E+12	38.7	17.6
36	Fed. Government	3.87E+07 \$	1.5E+12	58.1	26.4

Footnotes to Table 3-7 are in Appendix A

The value of mineral resources extracted in Macon are also shown in Table 3-7. The county was mining sand and gravel aggregate for construction at the rate of 1.76 E20 sej/y. The quantity of gemstones used for the analysis were only commercially mined. An appropriate emergy/gram was not available, but the emergy associated with the money paid for the gems was calculated to be of minor importance (0.001 E20 sej/y).

Present-day loss of mountain structure (80 g/m²/y) in Macon County was five (5) times as great as estimated pre-historic levels (15 g/m²/y). The value of the natural rate of loss--the proxy for pre-historic rates--was 0.20 E20 sej/y (10 E6 Em\$/y). With the introduction of man to the landscape, erosion rates were accelerated and the loss was 1.07 E20 sej/y (Table 3-7). The difference between the pre-historic and present-day rates amounted to an additional 0.87 E20 sej/y (44 E6 Em\$/y) being lost from the county.

Imported driving energies

Table 3-7 includes the emergy values for the driving energies that were imported to Macon. In step with the rest of the state, Macon County imported significant quantities of petroleum products (1.30 E20 sej/y). However, Macon did not import natural gas or coal, leaving its diversity of fuel-use lower than North Carolina's. The use of nuclear powered electricity in Macon was not investigated, but its possible that some of the electricity used was produced in this manner and delivered via an electrical grid network. In fact 37% (0.83 E20 sej/y) of the total electricity used in the county was imported directly.

In 1992, the net migration rate to Macon County was 503 people per year, 2% of the present population. Assuming they consumed resources at the rate of the average American, these additional people increased the empower demand of Macon county by 0.47 E20 sej/y (9% of annual total use).

Money spent by tourist represented 0.49 E20 sej/y, while their time visiting was valued at (2.74 E20 sej/y, Table 3-7). This was the largest single source of empower to the county.

Other imports included federal spending (0.58 E20 sej/y), machinery & equipment (0.20 E20 sej/y), and services associated with imported products (0.39 E20 sej/y).

Exports

Exports from Macon county are shown in Table 3-7. Exported products included tobacco, wood & wood products, livestock, non-fuel minerals, and services in exports and federal taxes. The total emergy value was 2.61 E20 sej/y (P1E plus N2 in Figure 3-20).

Summary of Macon County emergy use

Table 3-8 summarizes the emergy flows of Macon County by aggregating line items of Table 3-7 into categories that were based on the source of the energy. Figure 3-20 is a system diagram that defines the symbols used in Table 3-8.

The emergy analysis of the resource basis of Macon county's economy revealed that total emergy use was 5.08 E20 sej/y for the year 1992 (the sum of R, N0, N1, F, G, and P2I in Table 3-8). Assuming that the total emergy used was necessary to produce a county personal income of \$258 million for 1992, then the emergy-to-dollar ratio was 1.97 E12 sej/\$ (P1 in Table 3-8). That same year, North Carolina's was lower (1.18 E12 sej/\$); money in Macon purchased 1.75 times more wealth than the state average.

Table 3-8. Summary of flows in Macon county, N. C. circa, 1992.

Symbol	Item	Solar Emery (E18 sej/y)	Dollars
R	Renewable sources (rain chemical used, deep heat)	170	
N	Slow-renewable sources flow within Macon (N0, N1, N2)	272	
N0	Dispersed Rural Source (accelerated loss of sediment)	87	
N1	Concentrated Use (non-fuel minerals, gemstones)	38	
N2	Exported without Use (non-fuel minerals, wood)	146	
F	Imported Fuels and Minerals (oil derivatives, electricity)	213	
G	Imported Goods (machinery, transportation equip.)	20	
I	Dollars Paid for Imports		2.58E+07
P2I	Emery Value of Goods & Service Imports	39	
E	Dollars Received for Exports & Tourism		5.84E+07
P1E	Emery Value of Goods & Service Exports	128	
x	County Personal Income		2.58E+08
P2	U.S. emery/\$ ratio, used in imports	1.50E+12	
P1	Macon County Emery/\$ ratio	2.20E+12	
Z	Population, 1992	23,500	

* Letters are given on pathways in Figure 3-20 for reference.

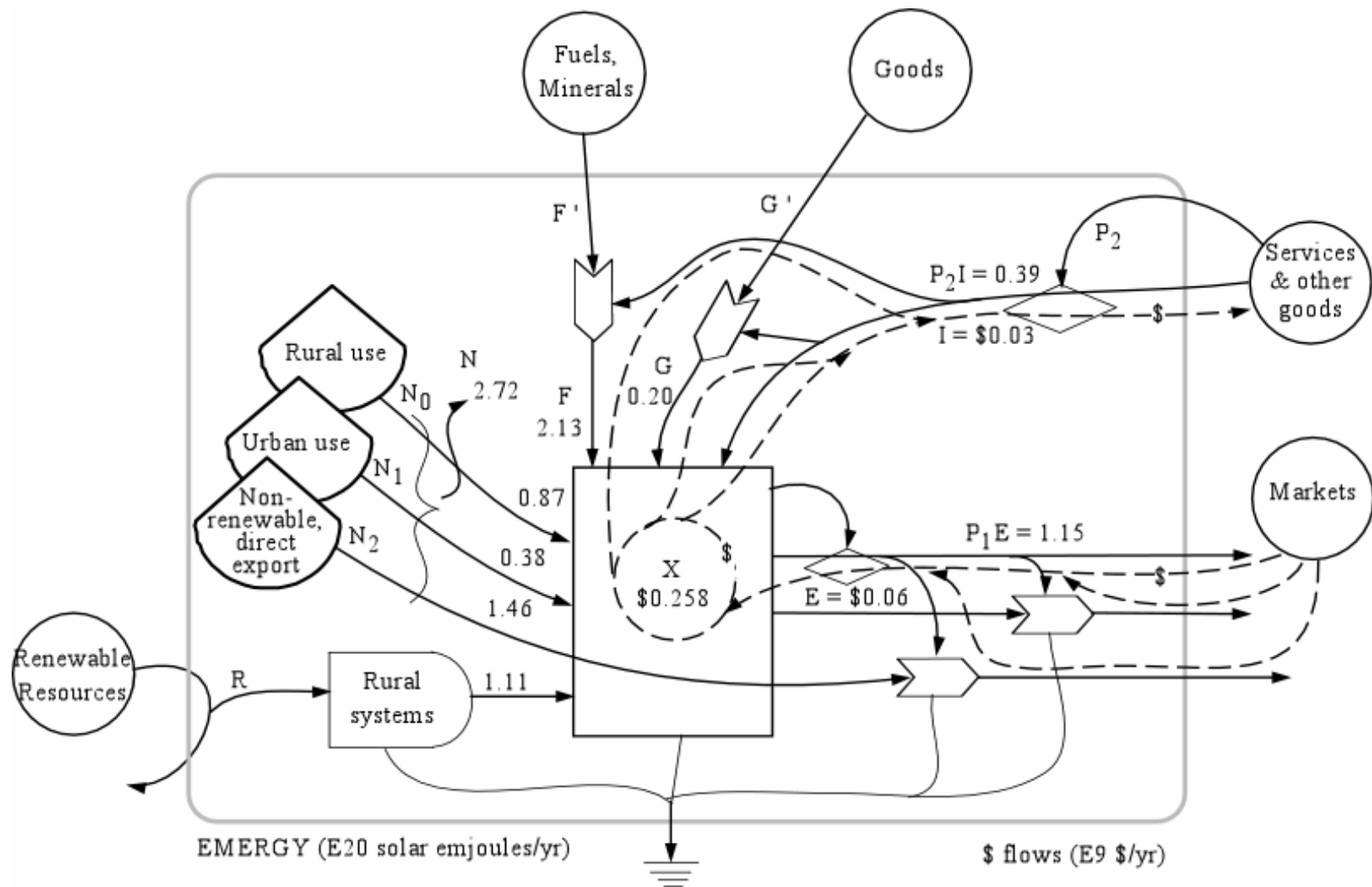

Figure 3-20. Summary diagram of emergy flows of Macon County, N.C. (1992).

Shown in Figure 3-21 are the power and empower spectra developed for Macon County. The county's power spectrum demonstrated the hierarchical property of energy use, just as the spectra for the Coweeta and WSC watersheds did. The use of low quality energy (e.g., sunlight) was vastly greater than the use of high transformity energies such as that associated with tourists and migrants (Figure 3-21a).

The empower spectrum in Figure 3-21b highlighted the significance of electricity and tourism in the county. Electricity use ($2.2 E_{20} \text{ sej/y}$) was about four and a half (4.5) times that of transpiration. Total people flux (tourism plus net migration) at $3.2 E_{20} \text{ sej/y}$ was 6.7 times transpiration.

North Carolina

The systems diagram of North Carolina (Figure 3-22) described the role of external environmental and economic energies in supporting the interconnections of the state's main ecological and economic units. Beginning on the left of the diagram, the main ecosystems of the coastal zone (beaches, estuaries, and shelf), forests, and agriculture seized the diverse spectrum of environmental energies--sun, wind (vapor deficit and kinetic energy), rain, tides, waves and geologic uplift--and transformed them to ecosystem goods and services available for economic production and life support. Mineral deposits (phosphate and aquifers) and mountains, large reserves created by past environmental processes, provided the foundation for such industries as hydroelectric power production and phosphate mining. Continuing rightward in the diagram, the economic sectors of electric power generation, mining, logging, manufacturing and commercial services transformed the goods and services of the ecosystems, with the assistance of imported fuels and services, into products and services for peoples'

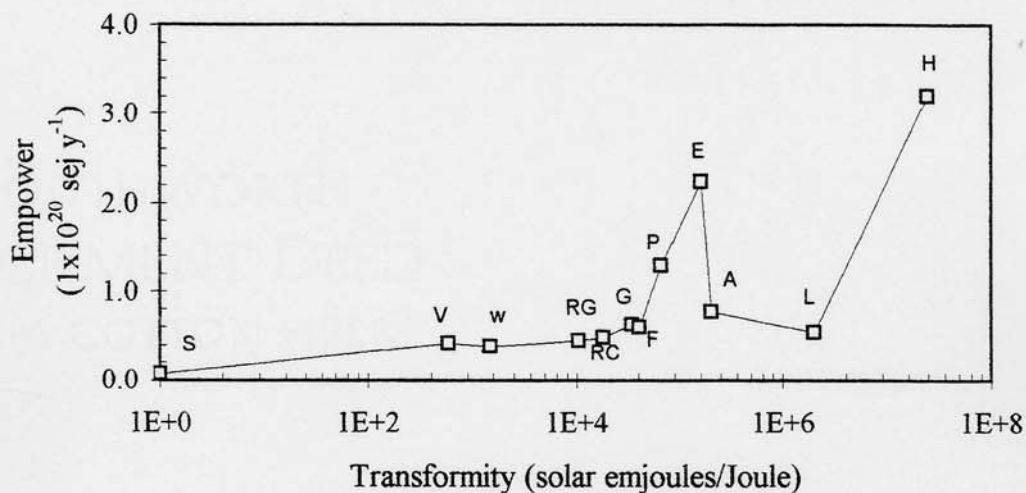
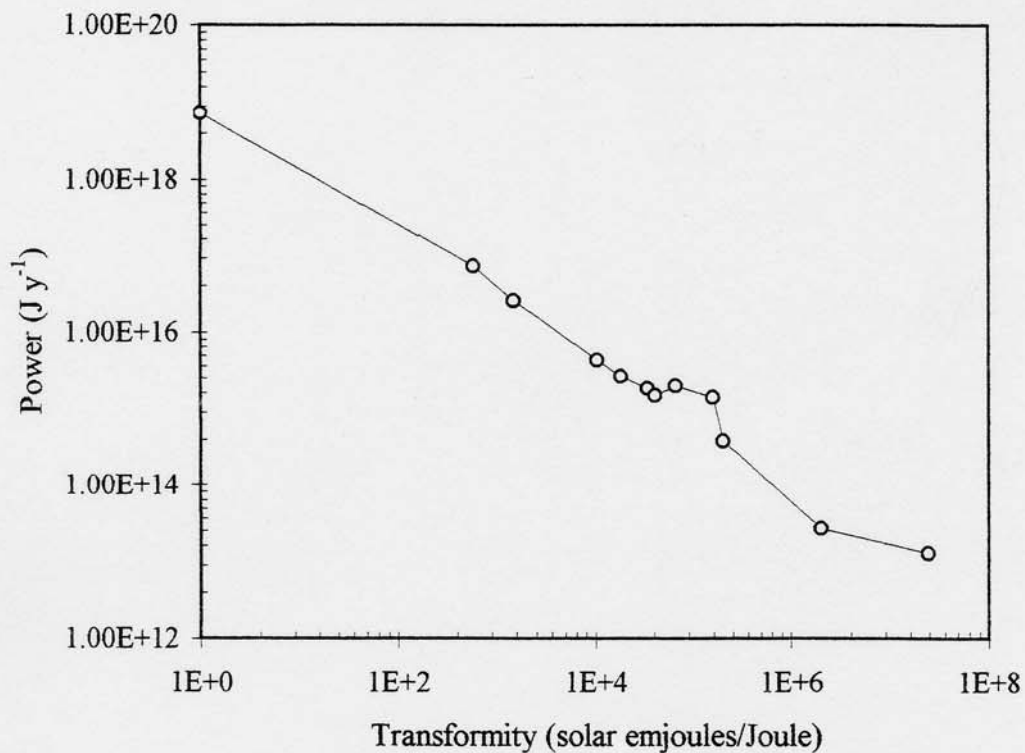

Figure 3-21. Power and empower spectra of the main resource inputs used in Macon County, N.C. (1992). Abbreviations: S-sunlight, V-water vapor deficit, W-kinetic wind, RG-geopotential of rain, RC-chemical potential of rain, G-geologic uplift, F-wood, P-petroleum, E-electricity, A-agricultural crops, L-livestock, H-human migration and tourism.

consumption. Furthest to the right in the diagram, N.C. traded goods and services, and exchanged money with outside markets and the federal government. The state also attracted tourists to its beaches and mountains. At every energy transformation, energy was irreversibly lost to the heat sink, shown at the bottom of the diagram.

Environmental driving energies of North Carolina

Renewable energy sources used in North Carolina are shown in Table 3-9. Rain chemical-potential (177 E20 sej/y; 15 E9 Em\$/y) provided the most empower.

Depression of the water vapor saturation deficit (95 E20 sej/y), wind kinetic energy (81 E20 sej/y), and deep heat (74 E20 sej/y) were nearly equal. The use of rain geopotential (18 E20 sej/y), waves (6 E20 sej/y), and tide (2 E20 sej/y) were significantly less.

Figure 3-23 shows that spatially, the intensity of environmental empower was greatest along the coastal counties, averaging as much as 8600 E12 sej/ha/y in Dare county. Coastal empower was due to the interaction of rain and wave energies. Tides were also important to coastal counties, but for the emergy analysis, tides could not be added as that would be double counting energy. Mountain counties had an intensity of environmental empower which averaged around 1300 E12 sej/ha/y. Piedmont and interior coastal plain counties had the lowest environmental empower density since rainfall was average, wave energy was of course zero, and geologic input (erosion) was smaller than the mountains.

Table 3-9 lists emergy values for the non-renewable resources used in North Carolina. Extraction of non-fuel minerals such as granite, clay, mica, and feldspar

Table 3-9. Emergy evaluation of resource basis for North Carolina, ca. 1992.

Note	Item	Physical Units		Trans- formity (sej/unit)	Solar Emergy (E20 sej)	Value to North Carolina Economy (1E9 Em\$, 1992)
RENEWABLE RESOURCES:						
1	Sunlight	8.65E+20	J	1	8.7	0.7
2	Rain, chemical	9.74E+17	J	1.8E+04	177.2	15.0
3	Rain, geopotential	1.14E+17	J	1.1E+04	12.0	1.0
4	Wind, kinetic	5.41E+18	J	1.5E+03	81.2	6.9
5	Saturation deficit	1.61E+19	J	5.9E+02	95.1	8.0
6	Hurricanes	3.01E+16	J	4.1E+04	12.4	1.0
7	Waves	1.80E+16	J	3.1E+04	5.5	0.5
8	Tide	1.12E+16	J	1.7E+04	1.9	0.2
9	Deep heat (state)	2.16E+17	J	3.4E+04	74.1	6.3
	Deep heat (mtn)	2.73E+16	J	3.4E+04	9.4	0.8
10	Historic sediment loss	1.38E+12	g	1.0E+09	13.8	1.2
INDIGENOUS RENEWABLE ENERGY USE:						
11	Hydroelectricity	2.09E+16	J	1.6E+05	33.3	2.8
12	Agriculture production	8.40E+16	J	2.0E+05	168.0	14.2
13	Livestock production	9.49E+15	J	2.0E+06	189.9	16.1
14	Fisheries harvest	2.50E+14	J	2.0E+06	5.0	0.4
15	Forest growth	4.75E+17	J	2.1E+04	99.3	8.4
16	Forest extraction	3.72E+17	J	4.1E+04	152.4	12.9
17	Fuelwood use	2.91E+16	J	4.1E+04	11.9	1.0
18	Direct water use	2.69E+15	J	5.4E+04	1.4	0.1
NONRENEWABLE SOURCES FROM WITHIN SYSTEM:						
19	Phosphate Rock	5.50E+12	g	3.9E+09	214.5	18.1
20	Present sediment loss	5.05E+12	J	1.0E+09	50.5	4.3
21	Total Electricity Use	3.44E+17	J	1.6E+05	547.6	46.3
22	Non-fuel minerals	5.61E+13	g	5.0E+08	280.3	23.7
23	Soil loss, agriculture	2.92E+16	J	6.3E+04	18.4	1.6
	Soil gain, forest land	3.25E+16	J	6.3E+04	20.5	1.7
IMPORTS AND OUTSIDE SOURCES:						
24	Petroleum Prods.	8.81E+17	J	6.6E+04	581.3	49.2
25	Natural Gas	1.99E+17	J	4.8E+04	95.3	8.1
26	Coal	7.66E+17	J	4.0E+04	304.7	25.8
27	Nuclear, electricity	8.16E+16	J	1.6E+05	129.7	11.0
28	Livestock, meat	1.08E+15	J	2.0E+06	21.5	1.8
29	Agriculture produce	4.34E+16	J	2.0E+05	86.7	7.3
30	Net Immigration	2.44E+14	J	2.5E+07	60.1	5.1
31	Metals	4.03E+12	g	1.0E+09	40.3	3.4
32	Wood, logs	2.58E+16	J	4.1E+04	10.6	0.9
33	Mach., transp. Equip.	2.48E+08	\$	1.4E+12	3.5	0.3
34	Other imports, service	1.47E+10	\$	1.4E+12	210.2	17.8
35	Tourism	2.13E+09	\$	1.4E+12	30.4	2.6
36	Fed. Government	2.89E+10	\$	1.4E+12	412.7	34.9

Table 3-9. continued.

EXPORTS:

37	Tobacco	3.82E+15	J	1.2E+06	43.9	3.7
38	Fishery Products	4.23E+13	J	2.0E+06	0.8	0.1
39	Livestock	7.46E+15	J	2.0E+06	149.1	12.6
40	Phosphate Rock	5.45E+12	g	3.9E+09	212.4	18.0
41	Cotton	5.21E+14	J	1.2E+06	6.0	0.5
42	Crushed stone	2.58E+13	g	5.0E+08	129.0	10.9
43	Lumber, furn., paper	1.42E+08	L. hr	1.3E+13	17.8	1.5
44	Service in exports	5.54E+10	\$	1.2E+12	655.1	55.4
45	Fed. Government	2.89E+10	\$	1.2E+12	341.2	28.9

Footnotes to Table 3-9 in Appendix A

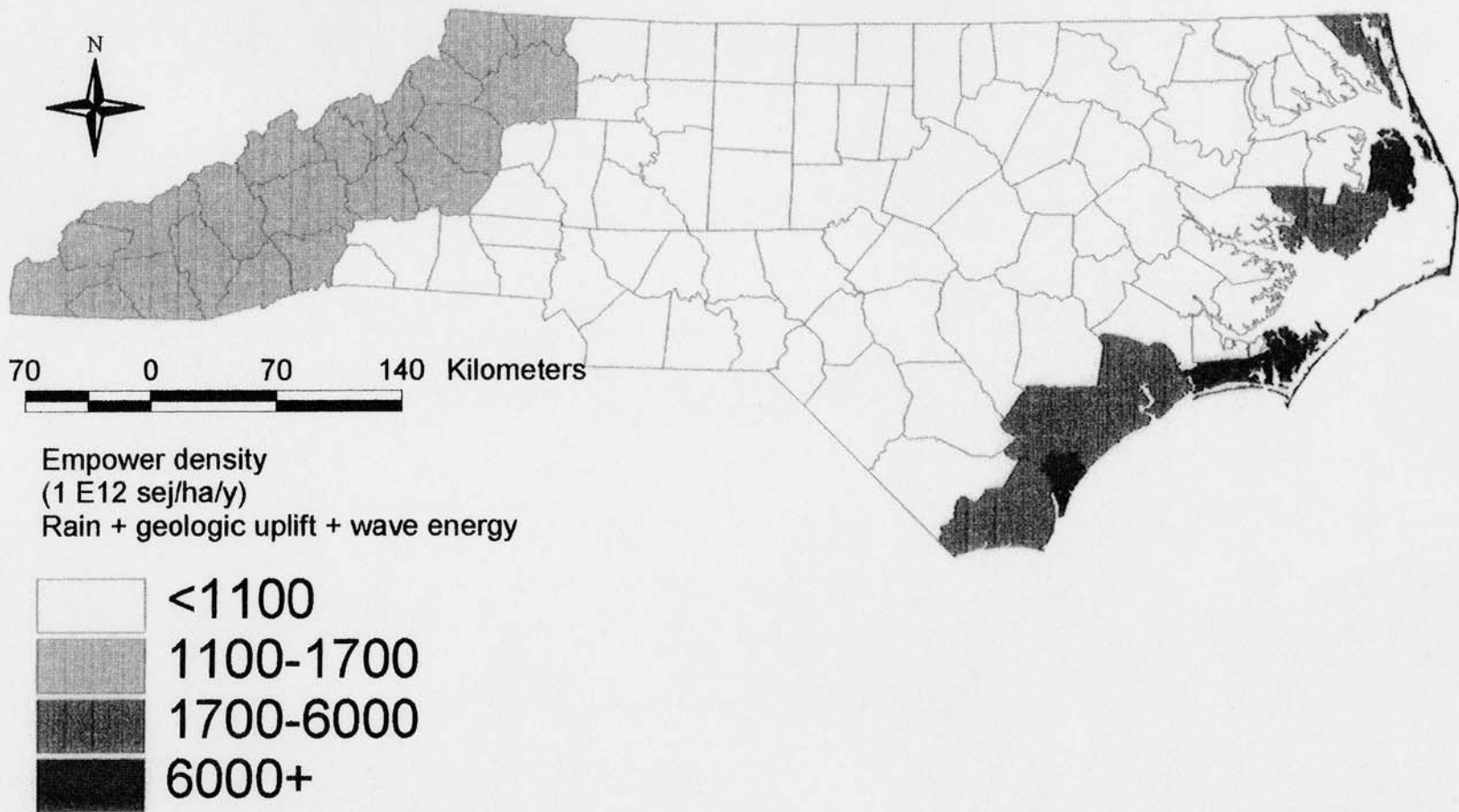

Figure 3-23. Renewable empower density of North Carolina by county. Mountain counties of western N.C. (gray) have average rainfall and high geologic uplift, counties of the piedmont and interior coastal plain (white) have average rainfall and low geologic input, counties abutting the sea (dark) have average rainfall and high wave energy.

occurred at the rate of 280 E20 sej/y. Mining of phosphate rock in eastern N.C. depleted the non-renewable stock at a rate of 215 E20 sej/y, but only 2 E20 sej/y (<1%) of the phosphate rock was used within N.C.

The present rate of erosion was valued at 47 E20 sej/y, which was accelerated beyond the background (pre-historic) rate (13 E20 sej/y) for a net difference of 34 E20 sej/y (see Table 3-9).

Imported driving energies

Table 3-9 also provides estimates for the emergy of imported goods, services, and fuel-energies. North Carolina relied heavily upon fossil fuels for economic production. Petroleum (581 E20 sej/y), coal (305 E20 sej/y), and natural gas (95 E20 sej/y) represented 52% of the total emergy used in the state. Production of electricity from nuclear power plants required the importation of uranium and added 130 E20 sej/y to N.C.'s emergy budget.

Imported meat and agricultural products were worth 147 E20 sej/y (Table 3-9). The state's industries imported metals, wood products and mechanical equipment, totaling 54 E20 sej/y.

From 1983 to 1992, net migration to N.C. averaged 100,000 people per year (1.4% of the 1992 population). The empower of the immigrants was 60 E20 sej/y (3.2% of state annual empower) assuming they represented the average American.

Tourism added a considerable amount of emergy to the state, 30 E20 sej/y (2.5 E9 Em\$/y).

Temporal trends in imported empower use in North Carolina. North Carolina's economy relied heavily upon an assortment of fuel energies to operate. From 1960 to 1994, N.C.'s total empower consumption from petroleum, coal, natural gas, nuclear and

hydroelectricity intensified 2.5-fold from 4.8 E22 sej/y to 12.3 E22 sej/y (Figure 3-24). Petroleum products provided the majority of fuel energy used, while coal was the second most important. In 1975, nuclear electricity was first produced in the state and has continued to increase in significance. In 1994 nuclear provided 15% of the empower from "fuel-energies".

Spatial configuration of imported empower. Spatially, the majority of counties receiving high inputs of imported energies were located in the Piedmont region (Figure 3-25). The exceptions to this pattern were New Hanover (Wilmington) and Cumberland (Fayetteville) counties in the Coastal Plain and Buncombe (Asheville) in the Blue Ridge province. Mecklenburg County, home to Charlotte, had the highest empower density due to imported resources (133 E15 sej/ha/y).

Internal processes

Forest growth. Figure 3-26 shows the growth in the forest growing stock and distribution of forest land in North Carolina. The data were calculated based on the U.S. Forest Service's Forest Inventory and Analysis (U.S. Forest Service, 1999). Growth in the growing stock in every county of N.C. was at least 1.25 MT/ha/y (500 E12 sej/ha/y) and greater than 2.75 MT/ha/y (1100 E12 sej/ha/y) in several eastern counties (Figure 3-26a). Growth in the growing stock was highest in the east and decreased toward the west. It was least in the mountain counties and intermediate to low in the piedmont counties. However, every mountain county had at least half (50%) of its land cover as forest, whereas urbanized piedmont counties and a few agricultural counties of the east had forest coverage less than 50% (Figure 3-26b). Therefore, many of the mountain counties

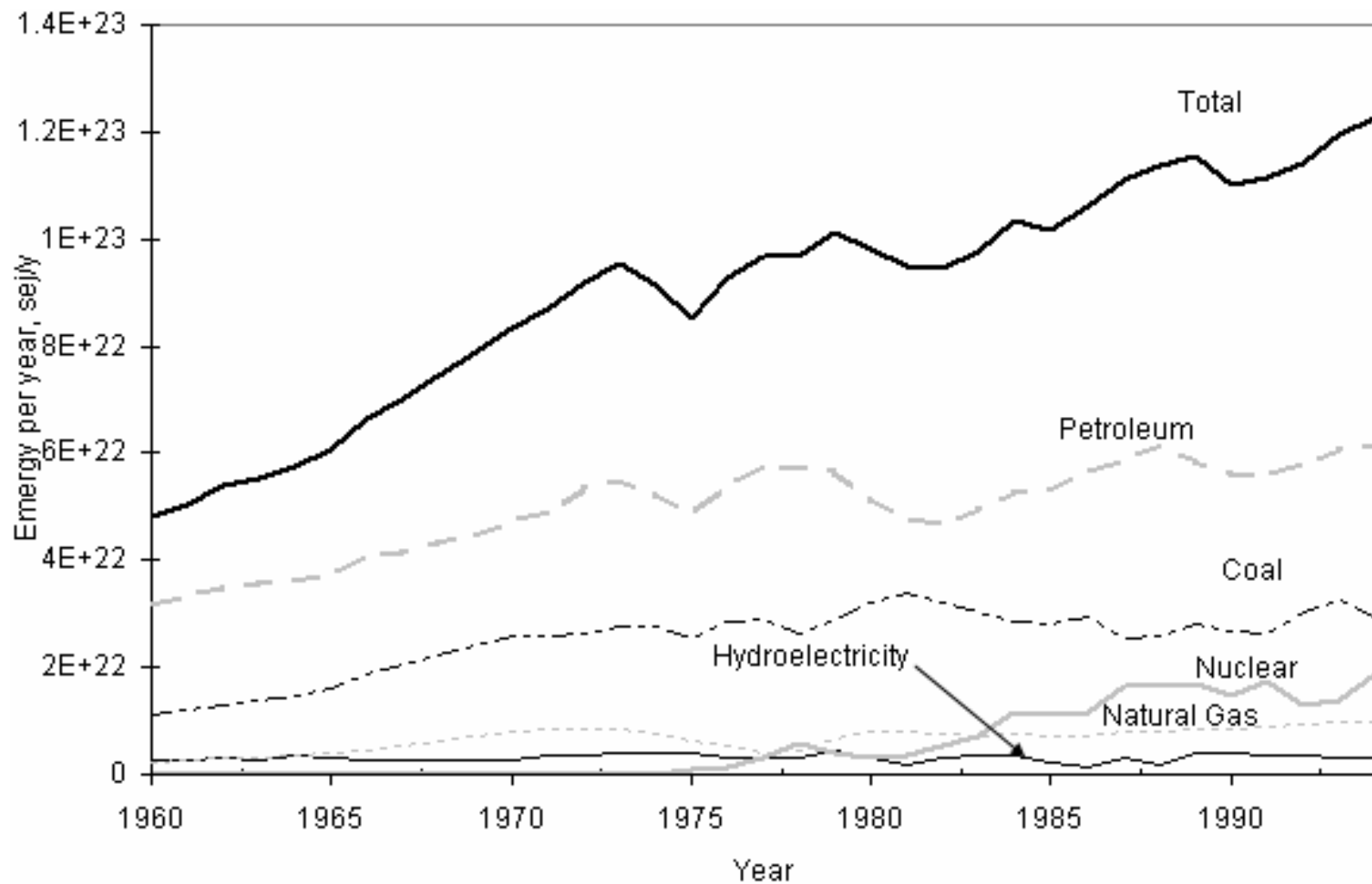

Figure 3-24. Historical consumption of primary fuels and electricity in North Carolina in units of energy (1960-1994).

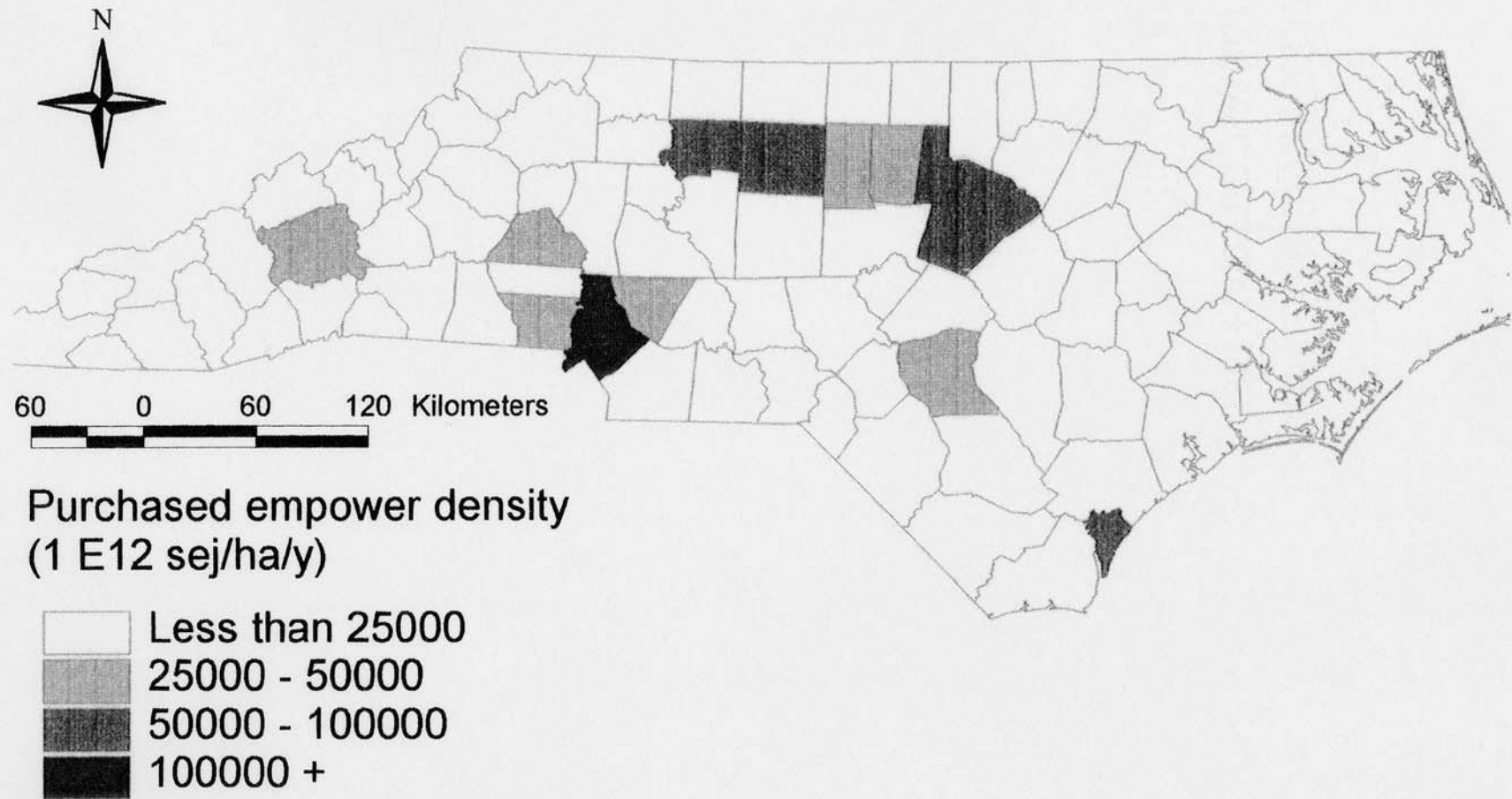

Figure 3-25. Purchased empower density of North Carolina by county. Urbanized counties of the piedmont region showed the greatest empower density derived from purchased goods and services. Mecklenburg county in the south central section of the state had the highest empower density.

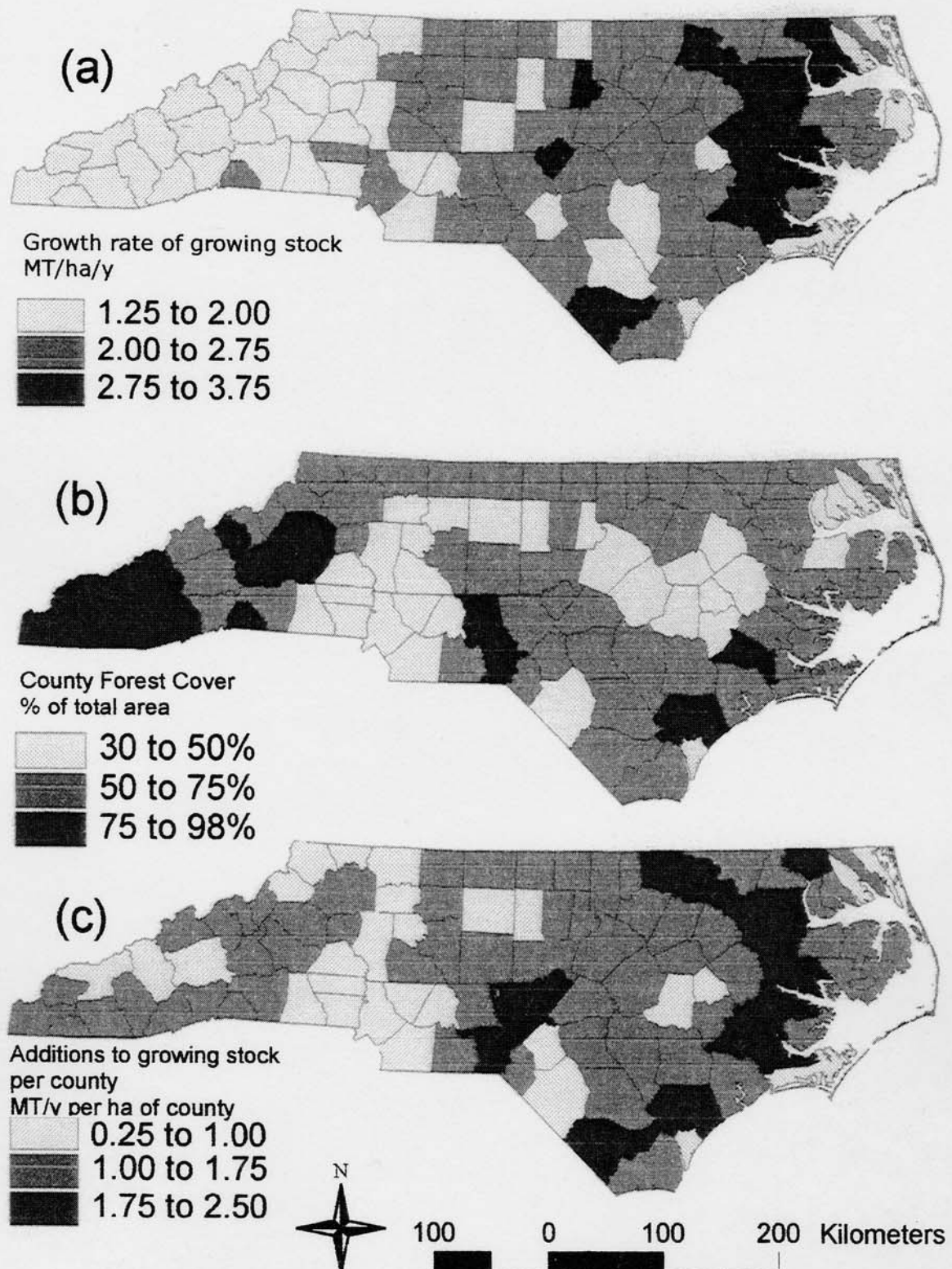

Figure 3-26. Maps of growth in growing stock (a), forest cover (b) and additions to growing stock (c) in North Carolina by county.

were accumulating forest stocks at total rates commensurate with the productive eastern counties (Figure 3-26c).

For the state as whole, wood accumulated at the rate of 99 E20 sej/y (25 E6 MT/y), but was harvested at the rate of 152 E20 sej/y (19 E6 MT/y). In terms of biomass, the harvest rate was less than the growth rate, but in emergy terms, more was being extracted than was growing. The harvested wood was a storage that accumulated emergy over its lifetime. As a result, it had a higher transformity than the annual growth. This difference in transformity explained the difference in emergy flow.

Water use. Figure 3-27a is a systems diagram of the water budget of North Carolina. Evaluation of the state water budget revealed that evapotranspiration equaled 115 billion m³/y, approximately 66% of total rainfall on land. The remaining 34% (59 billion m³/y) left as surface runoff. The overwhelming majority of river flow was directed outward from N.C. and in three directions: west, south, and east. (The Roanoke drainage basin straddled the northern border abutting Virginia. Since the inflow from Virginia was a small part of the overall state water budget, its contribution was overlooked for this study). West and south bound waters entered either Tennessee, Georgia or South Carolina, and were no longer available to do work in N.C. On the other hand, eastbound rivers entered the coastal waters of N.C. where the interaction of their geopotential and chemical potential energies still had the ability to contribute to the state.

The use of rainwater via evapotranspiration was 113 E20 sej/y (9.4 E9 Em\$/y; Figure 3-27b). Rainfall over the continental shelf added another 24 E20 sej/y (2.0 E9 Em\$/y).

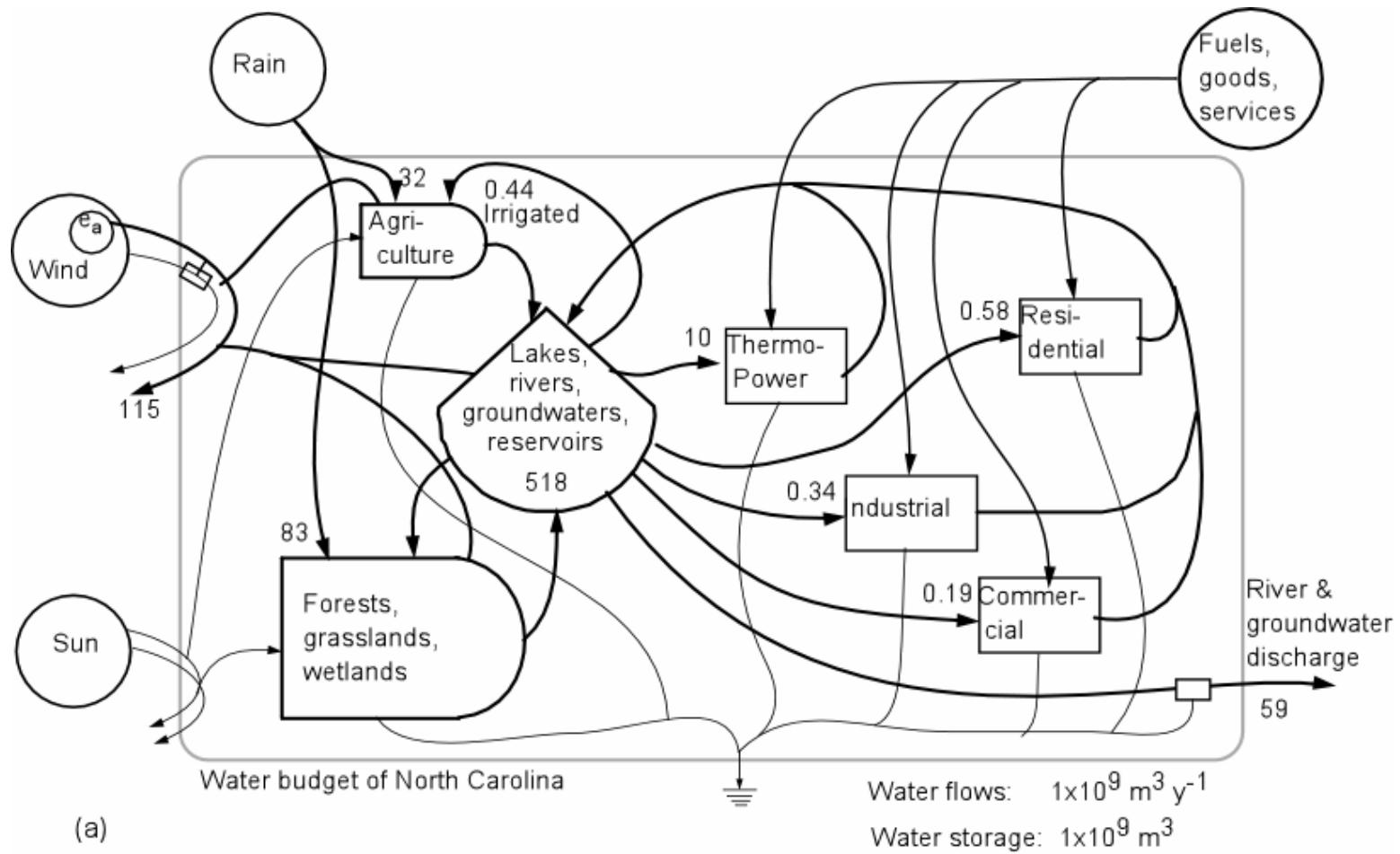

Figure 3-27. Systems diagrams of North Carolina's water budget (a) and water evaluated as energy (b) (1990).

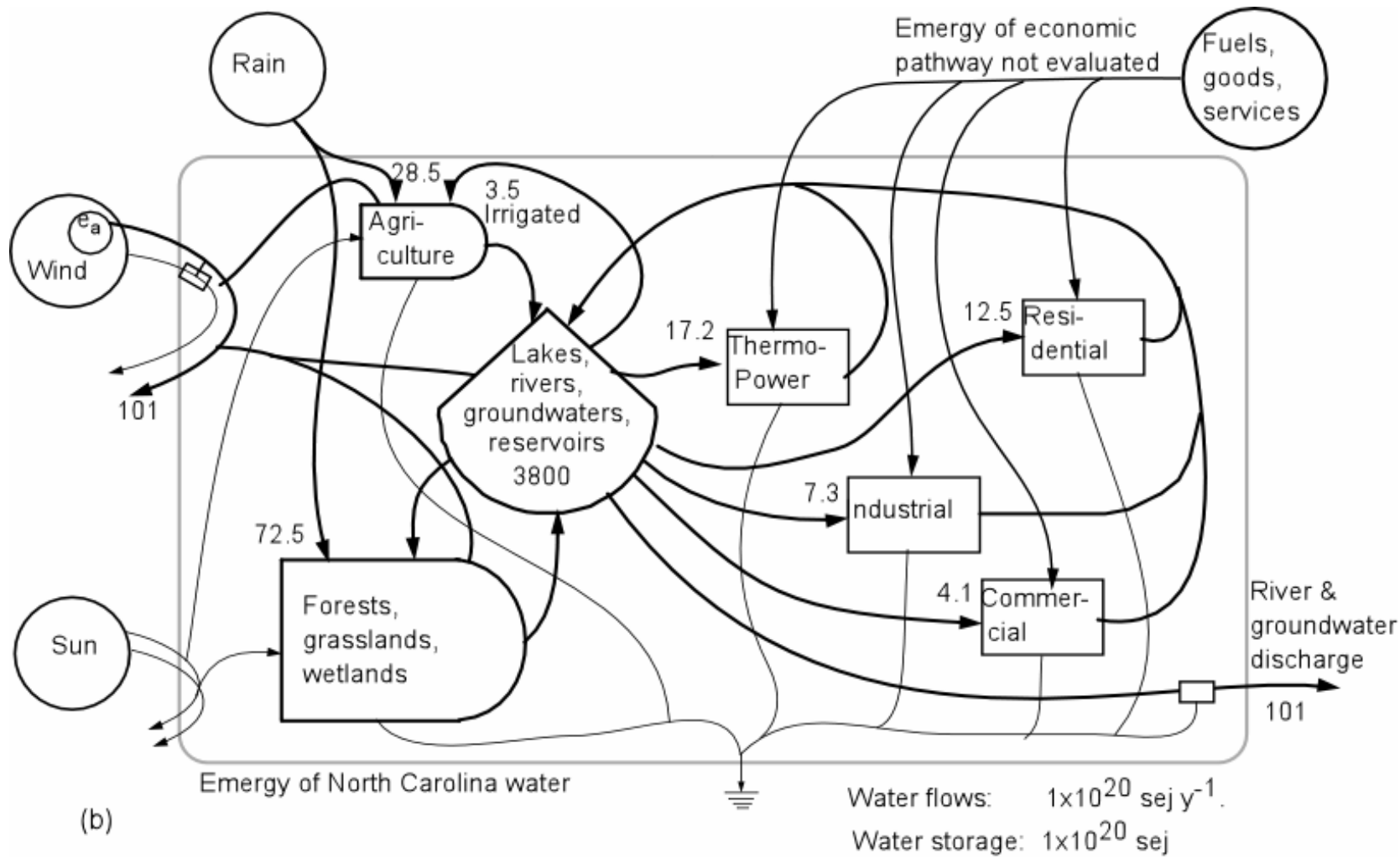

Figure 3-27. continued.

Forestry was the largest direct benefactor of N.C.'s rain, receiving 64 E20 sej/y (5.3 E9 Em\$/y; Figure 3-27b). Agriculture used 32 E20 sej/y (2.7 E9 Em\$/y) of rain water and supplemented it with 3.6 E20 sej/y (0.3 E9 Em\$/y) of irrigation water. Approximately 10 billion m³/y of water worth 19 E20 sej/y (1.6 E9 Em\$/y) was used as the coolant in thermoelectric power plants in 1990.

Water for drinking and washing (potable), lawn irrigation, and industrial and commercial processes required less than 1% (1.11 billion m³/y) of the total rainfall. Although this form of water consumption was small relative to forestry, agriculture and power plants, the value of the water (26 E20 sej/y) was comparable once the resources used to extract, treat, and transport were included.

North Carolina's abundant rainfall and elevated landscape interacted to provide an average of 47 billion kWh (169 E15 J) of water geopotential energy per year worth 18 E20 sej (1.5 E9 Em\$; see Table 3-9). Of this total, 5.4 billion kWh was transformed to hydroelectricity, with an upgraded value of 33 E20 sej (2.7 E9 Em\$). For comparison, in 1992, electricity produced from nuclear reactors provided 130 E20 sej and total electricity consumption was 548 E20 sej.

Natural capital

Table 3-10 shows the energy evaluation of major storages in North Carolina. Population represented the largest amount of stored energy (673 E22 sej). Economic assets of roads, bridges, buildings and other infrastructure were the next largest (384 E22). The largest stock of natural capital, topsoil, was valued at 255 E22 sej. Wood biomass and groundwater were determined to store 37 E22 sej and 38 E22 sej, respectively. The non-renewable reserve of phosphate rock represented 140 E22 sej.

Table 3-10. Emergy evaluation of resource storages of North Carolina, ca. 1992.

Note	Item	Raw Units	Trans- formity (sej/unit)	Solar Emergy (E22 sej)	Emdollar Value (1E9 Em\$, 1992)
Storages					
1	Phosphate	1.00E+14 g	14.0E+9	140	1167
2	Groundwater	2.52E+18 J	150,000	38	315
3	Wood Biomass	8.92E+18 J	41,000	37	305
4	Topsoil	2.75E+19 J	93,000	255	2128
5	Economic Assets	3.20E+12 \$	1.2E+12	384	3200
6	Population	2.17E+08 p- y	31.0E+15	673	5606
7	Surface Water	3.70E+16 J	41,000	0.2	1

Footnotes to Table 3-10 in Appendix A

Summary of North Carolina emergy use

Table 3-11 summarizes the emergy flows of North Carolina by aggregating line items of Table 3-9 into categories that were based on the energy source. Figure 3-28 is a system diagram that defines the letters used in Table 3-11.

Total emergy use in North Carolina ($R+N_0+N_1+F+G+P_2I$ in Table 3-11) was $1890 \text{ E}20 \text{ sej/y}$ for the year 1992. Assuming that the total emergy use was necessary to produce a gross state product of \$160 billion for 1992, then the emergy-to-dollar ratio was $1.18 \text{ E}12 \text{ sej}/\$$. That is, every dollar of economic product generated in N.C. represented, on average, a flow of $1.18 \text{ E}12 \text{ sej}$ of exogenous resource.

Figure 3-29 shows the power and empower spectra for North Carolina. As with the power and empower spectra developed for Coweeta watershed, WSC watershed, and Macon County, the spectra demonstrated the hierarchical property of energy use. That is, the vast majority of incoming energy was in the form of low transformity sunlight, while the highest quality energy source (human metabolism) contributed nearly the least amount of energy (Figure 3-29a). When energies were instead expressed as empower, the numerical differences between the sources were less, but still ranged well over two orders of magnitude (Figure 3-29b). Interesting to note was how the mid-quality energy sources ($1\text{E}4$ to $1\text{E}5 \text{ sej/J}$) vacillated in sequence with increasing transformity (Figure 3-29b).

The spectra highlight, visually, the importance of petroleum in the N.C. economy. The graphs were also a means of acknowledging the diversity of energy use. In total, nineteen (19) forms of energy contributed at least $1 \text{ E}20 \text{ sej/y}$ to the system of N.C (Figure 3-29b).

Table 3-11. Summary of flows in North Carolina, ca. 1992.

Letter	Item	Solar Emergy (E20 sej/y)	Dollars
R	Renewable sources (rain-land, rain-shelf, mountain deep heat)	187	
N	Nonrenewable sources flow within N.C. (N0+N1+N2)	556	
N0	Dispersed Rural Source (fish, forestry, soil loss, accelerated sediment loss)	212	
N1	Concentrated Use (Phosphate rock used within)	2	
N2	Exported without Use (Phosphate rock, granite)	341	
F	Imported Fuels and Minerals (oil prods., coal, nuclear elect., natural gas)	1111	
G	Imported Goods (meat, ag. produce, metals, wood)	159	
I	Dollars Paid for Imports		1.47E+10
P2I	Emergy Value of Goods & Service Imports	221	
B	Exported Goods (tobacco, cotton, livestock, wood prod., furniture)	217	
E	Dollars Received for Exports		5.54E+10
P1E	Emergy value of goods & service export	655	
X	Gross State Product		1.60E+11
P2	U.S. emergy/\$ ratio, used in imports	1.50E+12	
P1	North Carolina emergy/\$ ratio	1.18E+12	
Z	Population, 1992	6,910,000	

* Letters are given on pathways in Figure 3-25 for reference.

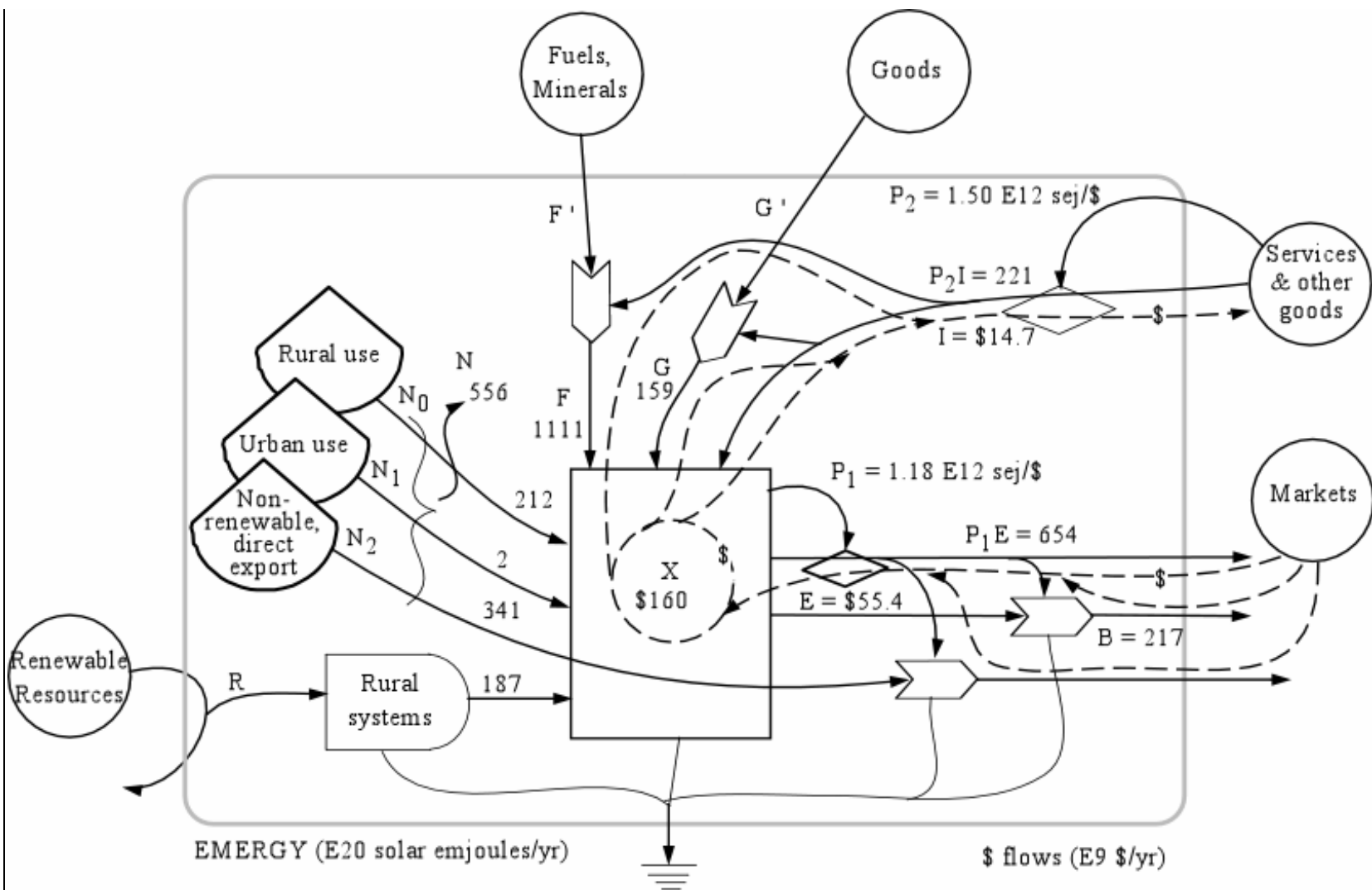

Figure 3-28. Summary diagram of energy flows of North Carolina in 1992.

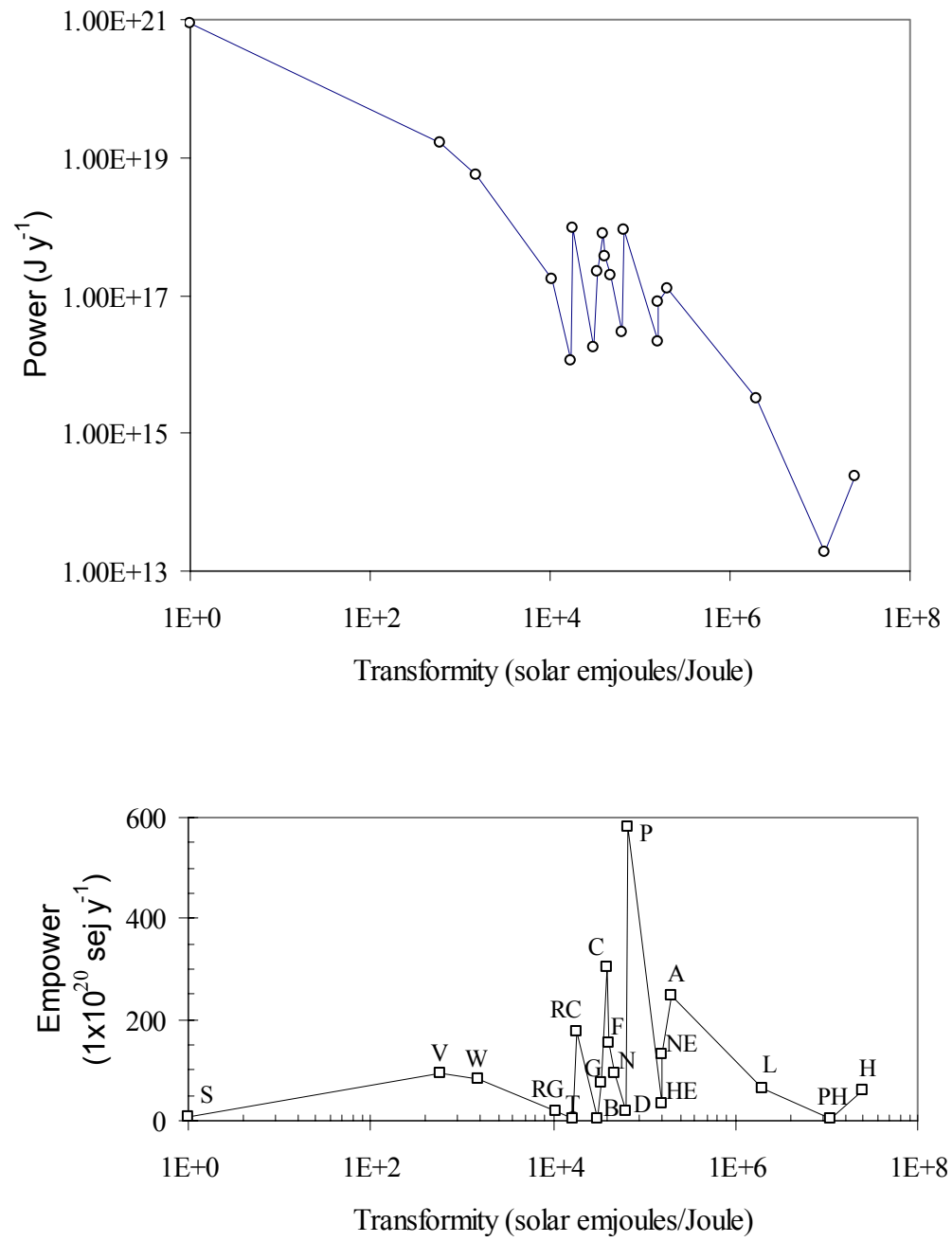

Figure 3-29. Power (a) and empower (b) spectra of the main resource inputs used in North Carolina, ca. 1992 (see Table 3-9 for details). Abbreviations: S-sunlight, V-water vapor deficit, W-kinetic wind, RG-geopotential of rain, T-tide, RC-chemical potential of rain, B-waves, G-geologic uplift, C-coal, F-wood, N-natural gas, D-soil, P-petroleum, HE-hydroelectricity, NE-nuclear electricity, A-agricultural crops, L-livestock, PH-phosphate mined & used, H-human migration and tourism.

U.S. Forest Products Industry

Emergy evaluation of the forest products industry included evaluations of seven (7) individual sectors: forest growth, logging, pulp mills, paperboard mills, paper mills, saw mills and plywood factories. Emergy evaluations of each sector are shown in Tables 3-12 through 3-18 and summarized in systems diagrams shown in Figure 3-30. Only independent sources of emergy are shown in the systems diagrams.

Table 3-12 and Figure 3-30a show the emergy evaluation of forest growth in North Carolina. This transformity was used as the transformity of wood biomass in the emergy evaluations of the lumber, plywood and pulpwood. The transformity of forest growth (2.1 E4 sej/J) was a function of transpiration and geologic weathering. The input of emergy from the two sources differed by only 28%.

The emergy evaluation of the logging industry is shown in Table 3-13 and Figure 3-30b. After wood, the emergy of human service was the most important. Petroleum and electricity provided only 7% of the emergy that services did. The solar transformity of harvested and delivered logs was 2.7 E4 sej/J .

Table 3-14 and Figure 3-30c shows the emergy evaluation of the woodpulp industry. The forms of emergy used were broadly and equally represented. Services, electricity, petroleum, coal, natural gas, and water ranged narrowly between 4 E20 sej/y to 26 E20 sej/y . The solar transformity of woodpulp was 6.0 E4 sej/J .

Paperboard production, shown in Table 3-15 and Figure 3-30d, required 193 E20 sej/y of services, which was more than any other input besides woodpulp (250 E20 sej/y). Recycled paper accounted for 69 E20 sej/y . Electricity (60 E20 sej/y), petroleum (15 E20 sej/y), coal (35 E20 sej/y), natural gas (42 E20 sej/y), and water (5 E20 sej/y) were all important inputs. The solar transformity of paperboard was 1.3 E5 sej/J .

In Table 3-16 and Figure 3-30e, the human service inputs (443 E20 sej/y) to the paper making industry were shown to be greater than the feedstock of woodpulp and recycled paper (319 E20 sej/y). More emergy was used in the form of electricity (188 E20 sej/y) than any other fuel source, although natural gas (133 E20 sej/y) was nearly as significant. Coal (109 E20 sej/y) was the next greatest source of emergy. Petroleum (47 E20 sej/y) and water (10 E20 sej/y) were significant. The solar transformity of paper was 2.4 E5 sej/J which was similar to Keller's (1992) estimate of 2.3 E5 sej/J calculated for a pulp mill in northern Florida.

Table 3-17 and Figure 3-30f shows that logs were the biggest source of emergy to the plywood and veneer industry. Next in importance was services, followed distantly by electricity, natural gas, and petroleum. The solar transformity of plywood was 1.1 E5 sej/J.

Emergy requirements of the lumber industry are shown in Table 3-18 and Figure 30g. After logs, services were the largest source of emergy. Electricity was by far the greatest source of fuel power. The solar transformity of lumber was 7.9 E4 sej/J.

Figure 3-31 shows systems diagrams that summarize the emergy, transformity and emergy-to-\$ ratios for the U.S. forest products industry (ca. 1990).

Figure 3-31a shows that the tree harvest of the United States, the base of the wood products industry, was worth 1300 E20 sej/y (118 billion Em\$/y). This amount of natural emergy was matched with purchased inputs to the individual wood sectors totaling 1977 E20 sej/y (180 billion Em\$/y).

Table 3-12. Emenergy evaluation of forest growth in North Carolina.

Note	Item	Physical Units	Trans- formity (sej/unit)	Solar Emenergy (E20 sej)	Emdollar Value (109 1992 Em\$)
Forest growth					
1	Sunlight	212.0E+18 J	1	2.1	0.2
2	Rain, chemical	317.0E+15 J	1.8E+04	57.7	5.2
3	Geologic input	120.7E+15 J	3.4E+04	41.5	3.8
	Sum of 2 and 3			99.2	9.0
4	Forest growth	474.9E+15 J			
5	Forest growth, transformity (sej/J)		2.1E+04		

Footnotes to Table 3-12

1 **SOLAR ENERGY**

Total Land Area of N.C. = 136.4E+9 m² (US Statistical Abstract 1995)
 Insolation @ Atmos = 6.3E+9 J/m²/yr (Barry & Chorley, 1992, p. 23)
 Albedo = 0.15 fraction absorbed at surface (Barry & Chorley, 1992)
 Forested area = 56% (US Statistical Abstract 1995)
 Energy(J)= (area)*(avg insolation)*(1-albedo)
 = (___m²)*(___J/m²/y)*(1-albedo)
 = 212.0E+18

2 **Rain, chemical**

Total Land Area of N.C. = 1.36E+11 m² (US Statistical Abstract 1995)
 Rain (land) = 1.27 m/yr Water Atlas of U.S., 1973.
 Evapotrans rate= 0.84 m/yr Water Atlas of U.S., 1973.
 Forested area = 56%
 Energy on forest land (J) = (area)(transpiration)(Gibbs no.)
 = (___m²)*(___m)*(1000 kg/m³)*(4940 J/kg)
 = 3.17E+17

3 **Geologic input**

Avg. deep heat generated in NC, J/m²/y = 1.58E+06 (avg. from Pollack et al, 1991)
 Deep heat of forested land, J/y = (1E6 J/m²/y)x(land area, m²)x(fraction forested)
 Deep heat of forested land, J/y = 1.21E+17

4 **Forest Growth**

New Growth = 4.95E+07 m³ Avg. 1983-89. Sheffield and Knight, 1986.
 Energy(J) = (___m³)(1E+06 g/m³)(0.5 g DW/GW)(19,200 J/g DW)
 = 4.75E+17

5 **Transformity of forest growth**

Transformity forest growth, sej/J = (Rain used + geologic input)/(energy of forest growth)
 Transformity, sej/J = (57.7 E20 sej + 41.5 E20 sej)/(475 E15 J)

Table 3-13. Energy evaluation of the logging industry in the United States, 1992.

Note	Item	Raw Units	Trans- formity sej/unit)	Solar Emergy (E20 sej)	Emdollar Value (1E9 1990)	
Logging						
1	Services	1.4E+10	\$	1.5E+12	208	13.8
2	Total Wages	1.7E+09	\$	1.5E+12	25	1.7
3	Non-labor wages	3.9E+08	\$	1.5E+12	6	0.4
4	Labor	6.0E+13	J	2.5E+07	15	1.0
5	Capital, @ 20 y life	1.9E+07	\$	1.5E+12	0.3	0.0
6	Biomass	6.2E+18	J	2.1E+04	1298	86.5
7	Electricity	1.6E+15	J	1.6E+05	2	0.2
8	Petroleum	2.3E+16	J	5.3E+04	12	0.8
	Sum of 1,6-8				1520	101.3
9	Timber Output	5.6E+18	J			
10	Timber Output, transformity(sej/J)			2.7E+04		
11	Emergy/\$ ratio for logs =	11.0E+12	sej/\$			

Footnotes to Table 3-13 in Appendix

Table 3-14. Emergy evaluation of woodpulp production in the United States, 1990.

Note	Item	Raw Units	Trans- formity (sej/unit)	Solar Emergy (E20 sej)	Macroeconomic Value (E9 1990 US\$)	
Woodpulp production						
1	Services	1.7E+09	\$	1.5E+12	25.6	1.7
2	Total Wages	6.9E+08	\$	1.5E+12	10.3	0.7
3	Non-labor wages	1.9E+08	\$	1.5E+12	2.8	0.2
4	Labor	1.1E+13	J	2.5E+07	2.6	0.2
5	Capital, @ 20 y life	3.9E+07	\$	1.5E+12	0.6	0.0
6	Biomass, logs	1.5E+18	J	2.7E+04	412.8	27.5
7	Electricity	9.1E+15	J	1.6E+05	14.5	1.0
8	Petroleum	3.0E+16	J	5.3E+04	16.0	1.1
9	Coal	1.1E+16	J	4.0E+04	4.2	0.3
10	Natural Gas	3.5E+16	J	4.8E+04	16.9	1.1
11	Water	4.1E+16	J	4.9E+04	20.1	1.3
	Sum of 1,6-11				510.1	34.0
12	Woodpulp output	8.5E+17	J			
13	Woodpulp output, transformity (sej/J)			6.0E+04		
	Emergy/\$ ratio for woodpulp = sum of 1,6-11 divided by \$ value of woodpulp					
	Emergy/\$ ratio for woodpulp					
	=	9.3E+12	sej/\$			

Footnotes to Table 3-14 are in Appendix

Table 3-15. Energy evaluation of paperboard production in the United States, ~1990.

Note	Item	Raw Units	Trans- formity (sej/unit)	Solar Emergy (E20 sej)	Macroeconomic Value (E9 1990 US\$)	
Paperboard production						
1	Services	1.3E+10	\$	1.5E+12	193.3	12.9
2	Total Wages	2.1E+09	\$	1.5E+12	32.0	2.1
3	Non-labor wages	6.0E+08	\$	1.5E+12	9.0	0.6
4	Labor	3.4E+13	J	2.5E+07	8.4	0.6
5	Capital, @ 20 y life	1.0E+08	\$	1.5E+12	1.5	0.1
6	Woodpulp	4.2E+17	J	6.0E+04	250.3	16.7
7	Recycled paper	1.1E+17	J	6.0E+04	68.8	4.6
8	Electricity	3.7E+16	J	1.6E+05	59.6	4.0
9	Petroleum	2.8E+16	J	5.3E+04	14.9	1.0
10	Coal	8.7E+16	J	4.0E+04	34.7	2.3
11	Natural Gas	8.8E+16	J	4.8E+04	42.2	2.8
12	Water	9.6E+15	J	4.9E+04	4.6	0.3
	Sum of 1,6-12				668.4	44.6
13	Paperboard output	5.1E+17	J			
14	Paperboard output, transformity (sej/J)			1.3E+05		
	Emergy/\$ ratio for paperboard = sum of 1,6-12 divided by \$ value of paperboard					
	Emergy/\$ ratio for paperbd					
	=	4.1E+12	sej/\$			

Footnotes to Table 3-15 in Appendix

Table 3-16. Energy evaluation of paper production in the United States, ~1990.

Note	Item	Raw Units	Trans- formity (sej/unit)	Solar Emergy (E20 sej)	Macroeconomic Value (E9 1990 US\$)
Paper production					
1	Services	3.0E+10 \$	1.5E+12	443.0	29.5
2	Total Wages	5.4E+09 \$	1.5E+12	81.3	5.4
3	Non-labor wages	1.5E+09 \$	1.5E+12	22.6	1.5
4	Labor	8.7E+13 J	2.5E+07	21.5	1.4
5	Capital, @ 20 y life	1.5E+08 \$	1.5E+12	2.2	0.1
6	Woodpulp	4.2E+17 J	6.0E+04	250.3	16.7
7	Recycled paper	1.1E+17 J	6.0E+04	68.8	4.6
8	Electricity	1.2E+17 J	1.6E+05	187.7	12.5
9	Petroleum	8.9E+16 J	5.3E+04	46.9	3.1
10	Coal	2.7E+17 J	4.0E+04	109.3	7.3
11	Natural Gas	2.8E+17 J	4.8E+04	133.1	8.9
12	Water	2.1E+16 J	4.9E+04	10.0	0.7
	Sum of 1,6-12			1249.0	83.3
13	Paper output	5.2E+17 J			
14	Paper output, transformity (sej/J)		2.4E+05		
	Emergy/\$ ratio for paper = sum of 1,6-12 divided by \$ value of paper				
	Emergy/\$ ratio for paper =	3.8E+12	sej/\$		

Footnotes to Table 3-16 in Appendix

Table 3-17. Energy evaluation of plywood & veneer production in the U.S., ~1990.

Note	Item	Raw Units	Trans- formity (sej/unit)	Solar Emergy (E20 sej)	Macroeconomic Value (E9 1990 US\$)
Plywood & veneer production					
1	Services	6.6E+09	\$ 1.5E+12	98.3	6.6
2	Total Wages	1.2E+09	\$ 1.5E+12	18.3	1.2
3	Non-labor wages	2.3E+08	\$ 1.5E+12	3.5	0.2
4	Labor	3.9E+13	J 2.5E+07	9.6	0.6
5	Capital, @ 20 y life	7.3E+06	\$ 1.5E+12	0.1	0.0
6	Logs	4.6E+17	J 2.7E+04	125.3	8.4
7	Electricity	6.1E+15	J 1.6E+05	9.6	0.6
8	Petroleum	2.4E+15	J 5.3E+04	1.3	0.1
9	Coal	2.8E+14	J 4.0E+04	0.1	0.0
10	Natural Gas	4.0E+15	J 4.8E+04	1.9	0.1
	Sum of 1,6-10			236.6	15.8
11	Plywood output	2.1E+17	J		
12	Plywood output, transformity		J 1.1E+05		
	Emergy/\$ ratio for plywood = sum of 1,6-10 divided by \$ value of plywood				
	Emergy/\$ ratio for plywood =	3.1E+12	sej/\$		

Footnotes to Table 3-17 in Appendix

Table 3-18. Emergy evaluation of lumber production in the United States, ~1990.

Note	Item	Raw Units		Trans- formity (sej/unit)	Solar Emergy (E20 sej)	Macroeconomic Value (E9 1990 US\$)
Lumber production						
1	Services	1.5E+10	\$	1.5E+12	231.4	15.4
2	Total Wages	3.0E+09	\$	1.5E+12	45.7	3.0
3	Non-labor wages	6.5E+08	\$	1.5E+12	9.7	0.6
4	Labor	1.0E+14	J	2.5E+07	25.3	1.7
5	Capital, @ 20 y life	2.3E+07	\$	1.5E+12	0.3	0.0
6	Logs	2.3E+18	J	2.7E+04	622.8	41.5
7	Electricity	1.7E+16	J	1.6E+05	26.4	1.8
8	Petroleum	6.6E+15	J	5.3E+04	3.5	0.2
9	Coal	7.5E+14	J	4.0E+04	0.3	0.0
10	Natural Gas	1.1E+16	J	4.8E+04	5.3	0.4
	Sum of 1,6-10				889.7	59.3
11	Lumber output	1.1E+18	J			
12	Lumber output, transformity			7.9E+04		
	Emergy/\$ ratio for lumber = sum of 1,6-10 divided by \$ value of lumber					
	Emergy/\$ ratio for lumber = 4.2E+12 sej/\$					

Footnotes to Table 3-18 in Appendix

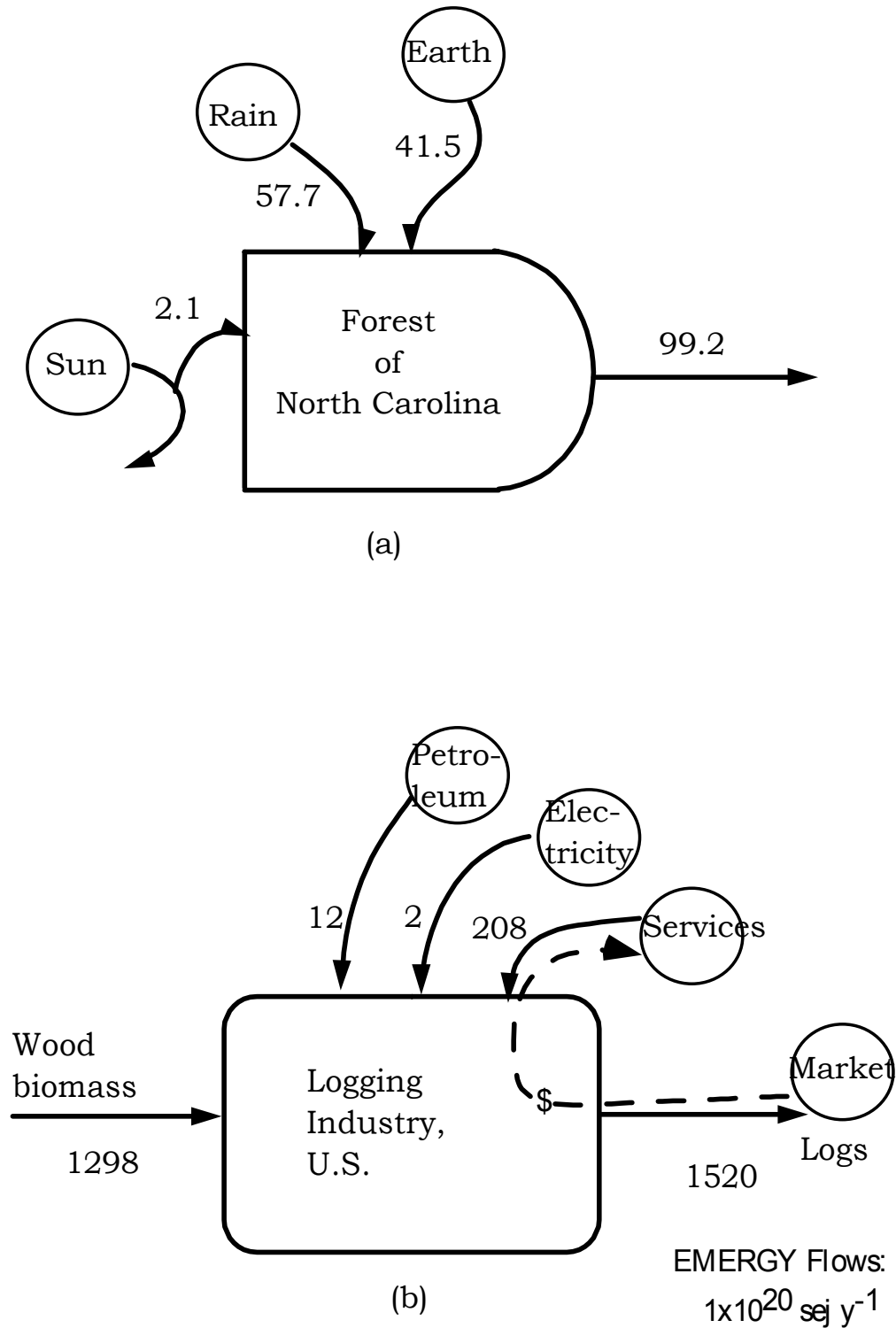
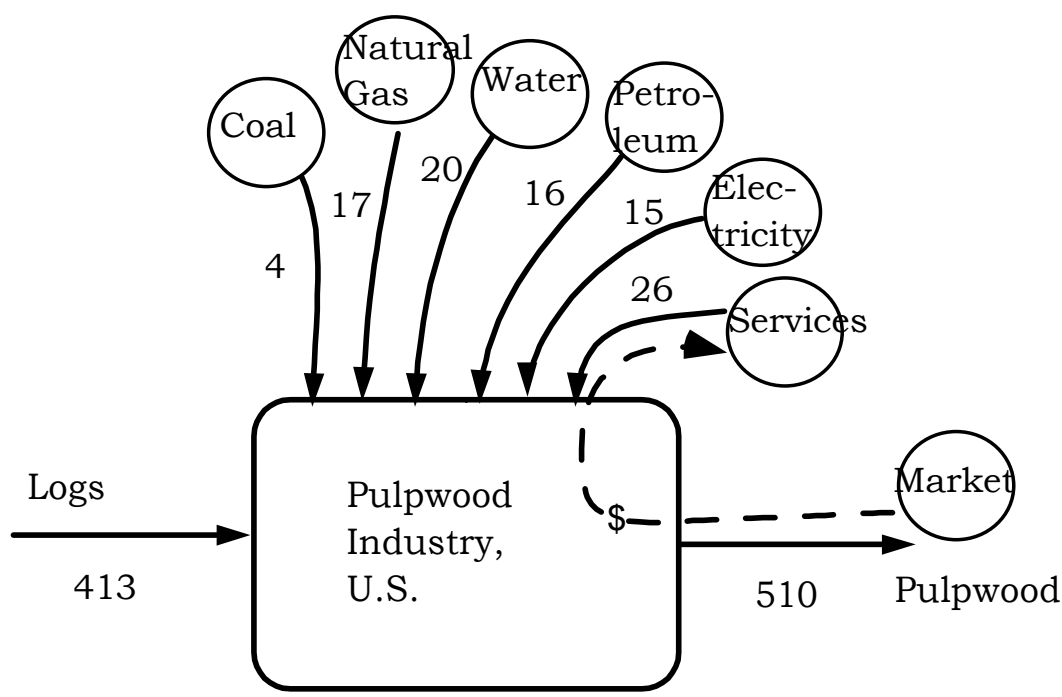
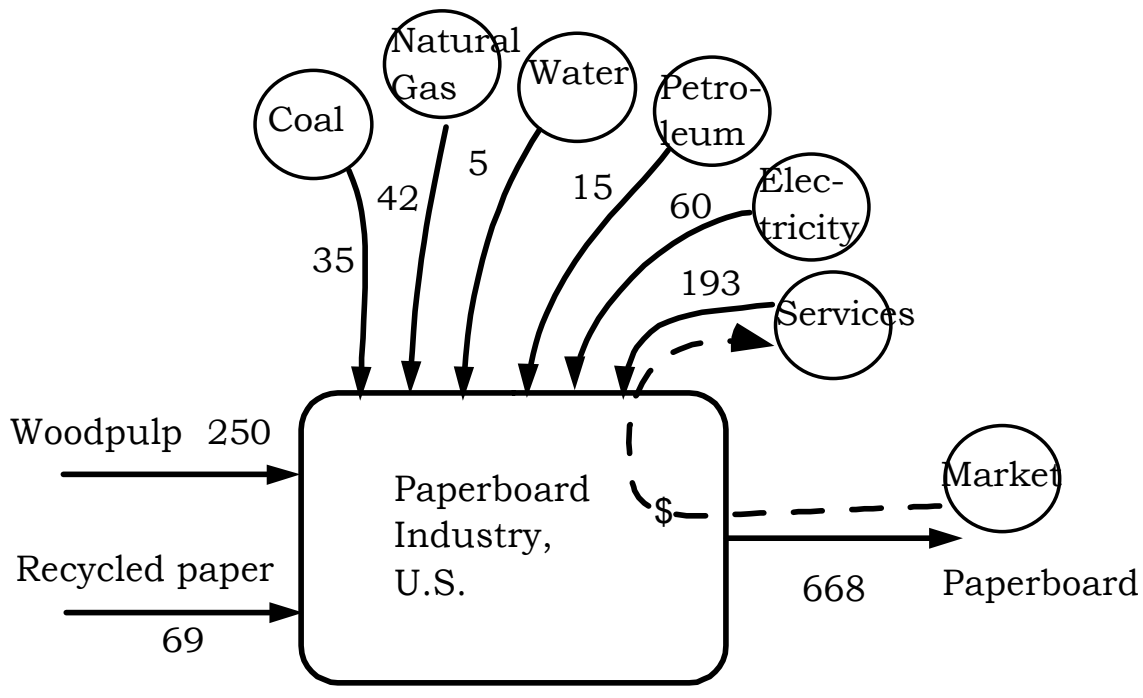

Figure 3-30. Systems diagrams of the energy inputs to the individual sectors of the forest products industry. The sectors are: forest growth in North Carolina (a) logging (b), pulpwood (c), paperboard (d), paper (e), plywood (f), and lumber (g).



(c)



(d)

ENERGY Flows:
 1×10^{20} sej y^{-1}

Figure 3-30. continued.

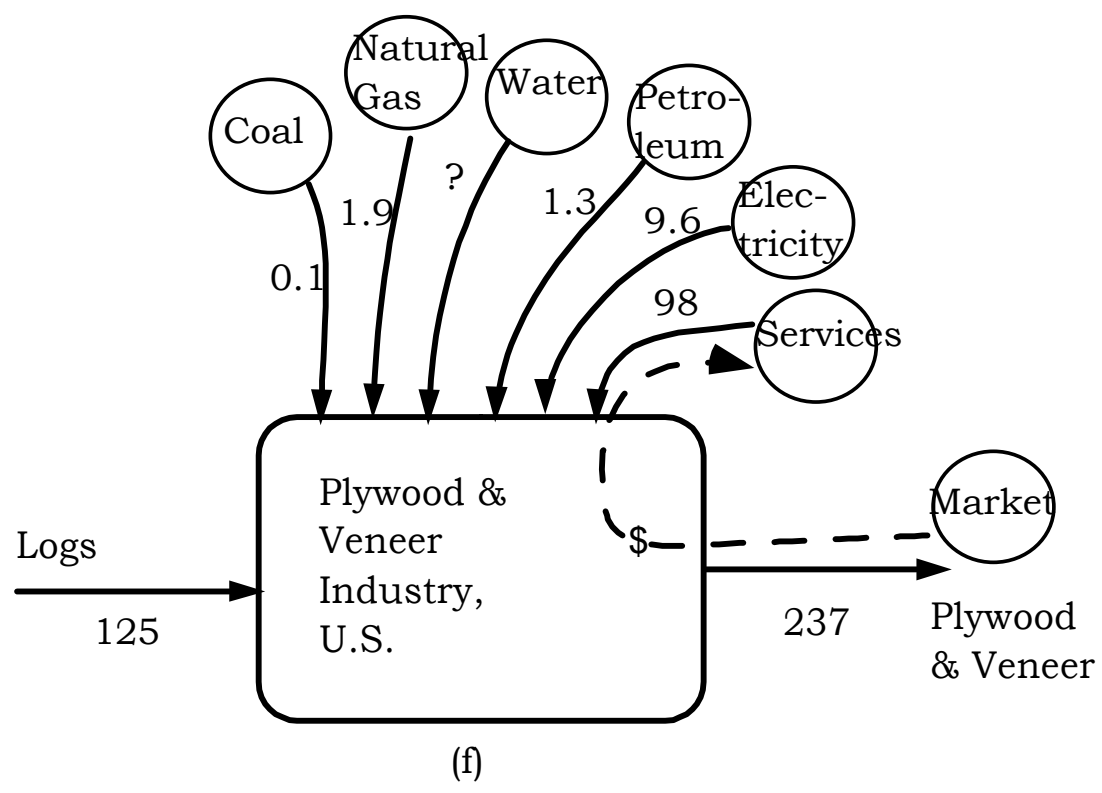
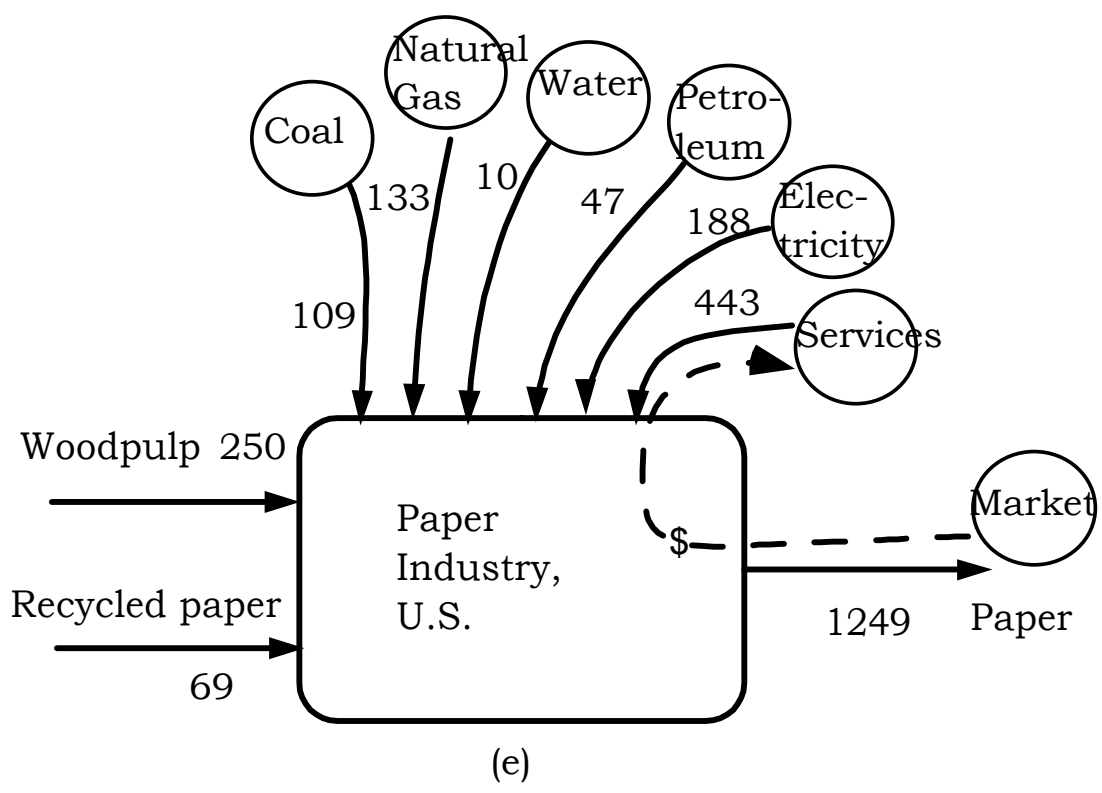
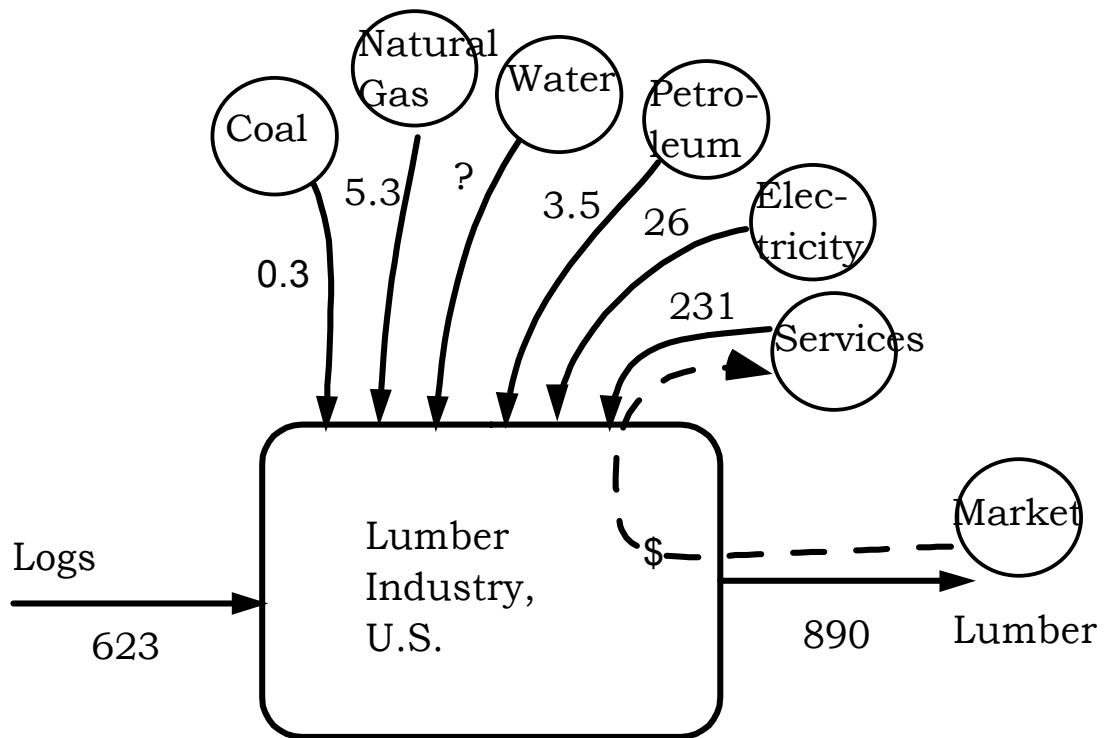

Figure 3-30. continued.

EMERGY Flows:
 $1 \times 10^{20} \text{ sej } y^{-1}$



(g)

ENERGY Flows:
 $1 \times 10^{20} \text{ sej y}^{-1}$

Figure 3-30. continued.

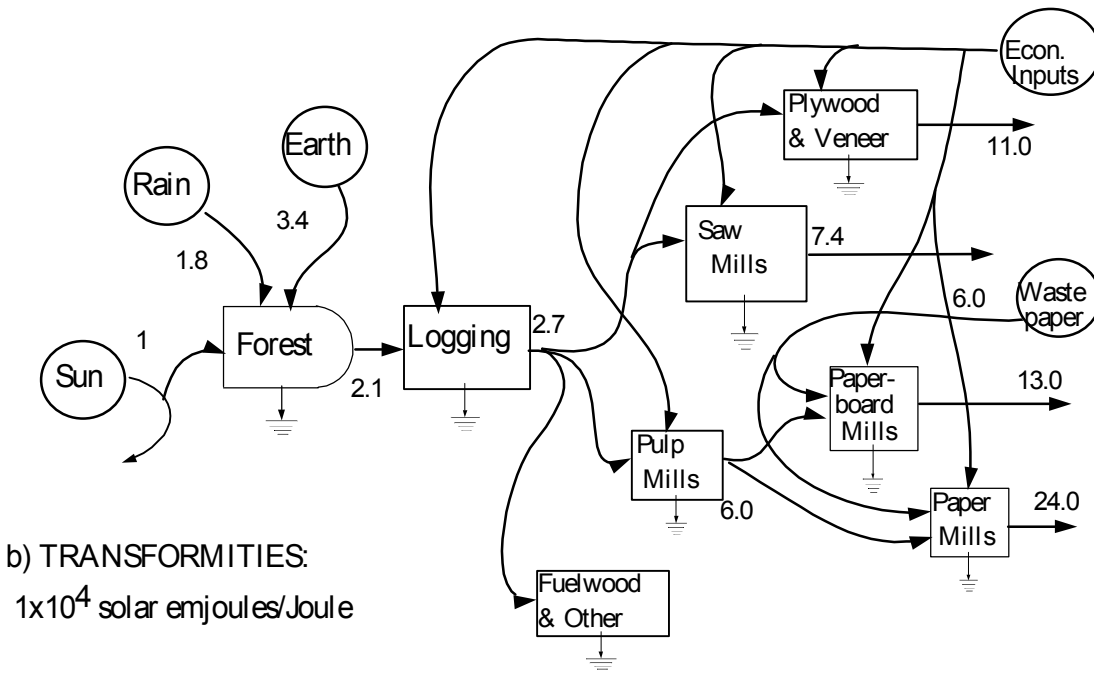
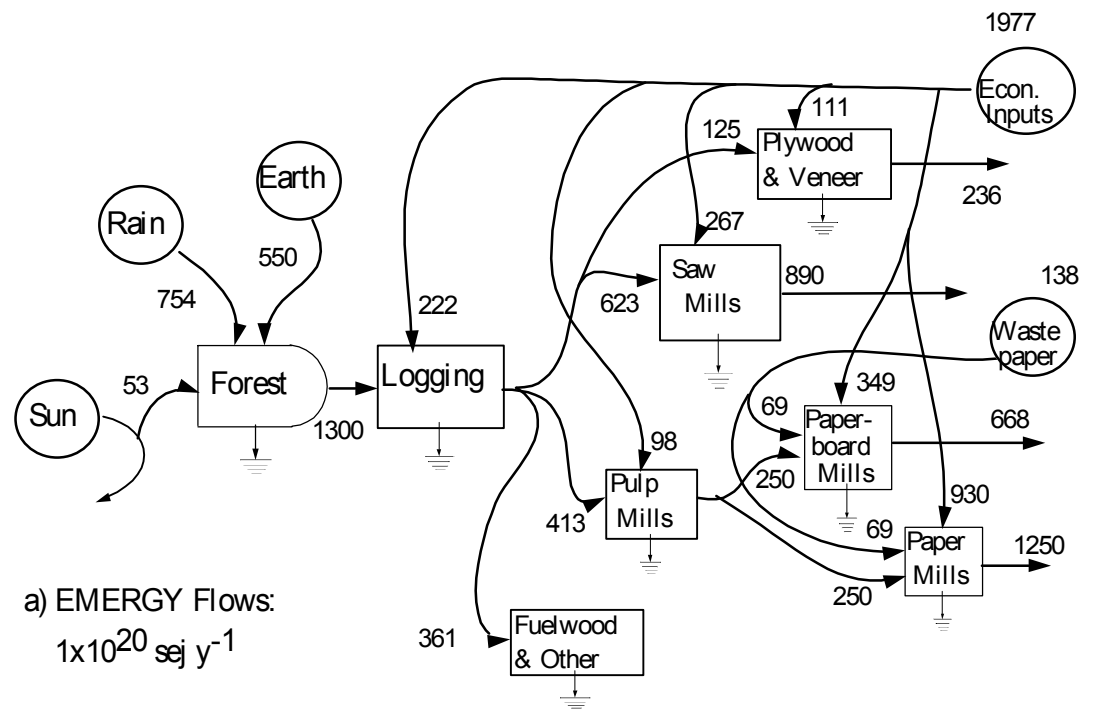

Figure 3-31. Systems diagrams summarizing the emergy flow (a), transformities (b), and emergy-to-dollar ratios (c) for the U.S. forest products industry (ca. 1990).

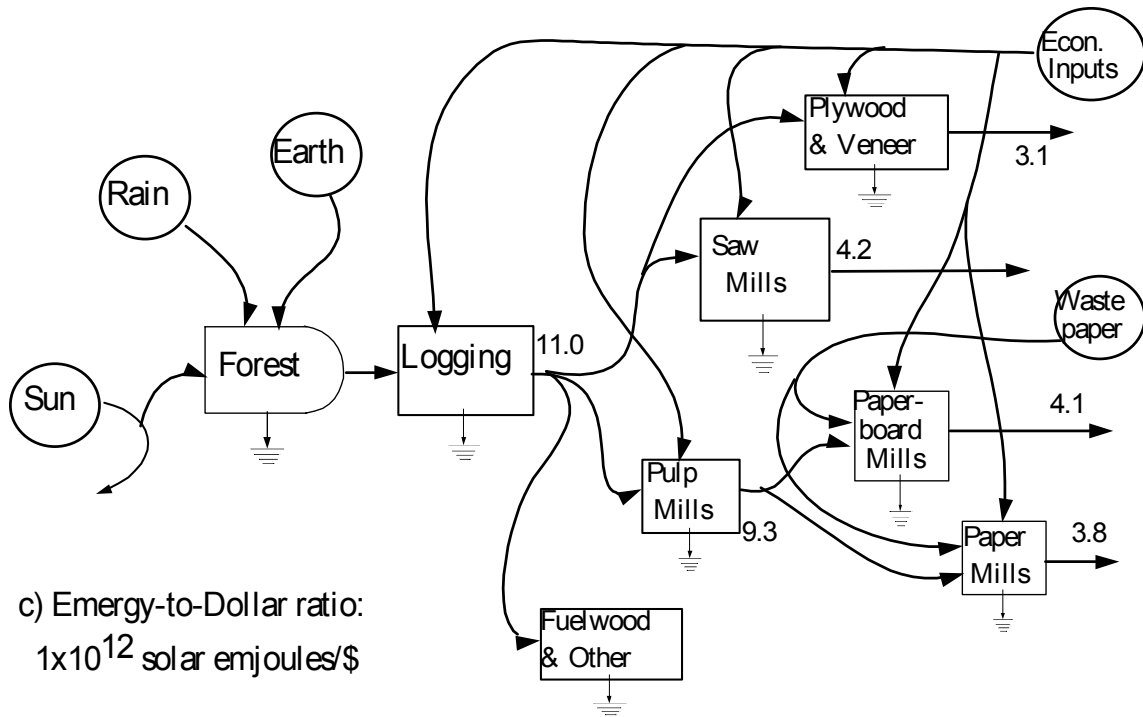

Figure 3-31. continued.

Figure 3-31b shows that the transformities of forest products increased throughout the chain of industrial processes. The transformity of harvested tree biomass was $2.1 \text{ E}4 \text{ sej/J}$, while at the other end of the industrial chain, paper had a transformity of $2.4 \text{ E}5 \text{ sej/J}$; an increase of 115%. Paper with a transformity of $2.4 \text{ E}5 \text{ sej/J}$, represented only 7% of the total timber harvest in terms of biomass, but had an emergy value ($1250 \text{ E}20 \text{ sej/y}$) equivalent to 83% of the timber harvest.

Shown in Figure 3-31c is the progressive decrease in the emergy-to-dollar ratio of forest products. The emergy-to-dollar ratio was the total empower in a production sector divided by the total revenue for that sector. Each dollar of revenue in the logging-sector had $11.0 \text{ E}12 \text{ sej}$ associated with it, while the paper-sector had $3.8 \text{ E}12 \text{ sej}$. The average emergy-to-\$ ratio for the whole U.S. economy in 1993 was $1.5 \text{ E}12 \text{ sej/}$.

Figure 3-32 shows the emergy-to-dollar ratio as a function of solar transformity for wood products. Lower transformity products had higher emergy-to-dollar ratios.

International Trade of Forest Products

Shown in Figure 3-33 is a systems diagram of the balance of trade in forest products between the U.S., Canada, and Mexico. The diagram compares emdollar flows to the counter-current dollar flow. The U.S. received $3.4 \text{ E}9 \text{ Em}$ of forest products from Mexico and $87 \text{ E}9 \text{ Em}$ from Canada, for which the U.S. paid $\$0.7 \text{ E}9$ and $\$20 \text{ E}9$, respectively. The U.S. shipped $28 \text{ E}9 \text{ Em}$ of product and received $\$6.4 \text{ E}9$. Mexico received $8.5 \text{ E}9 \text{ Em}$ worth of wood products from the U.S., for which they paid $\$2.1 \text{ E}9$. Canada paid $\$4.3 \text{ E}9$ for product valued at $19 \text{ E}9 \text{ Em}$.

In total, after enactment of NAFTA (North American Free Trade Agreement), the U.S. had an annual trade surplus in forest products (wood logs, pulpwood, and paper)

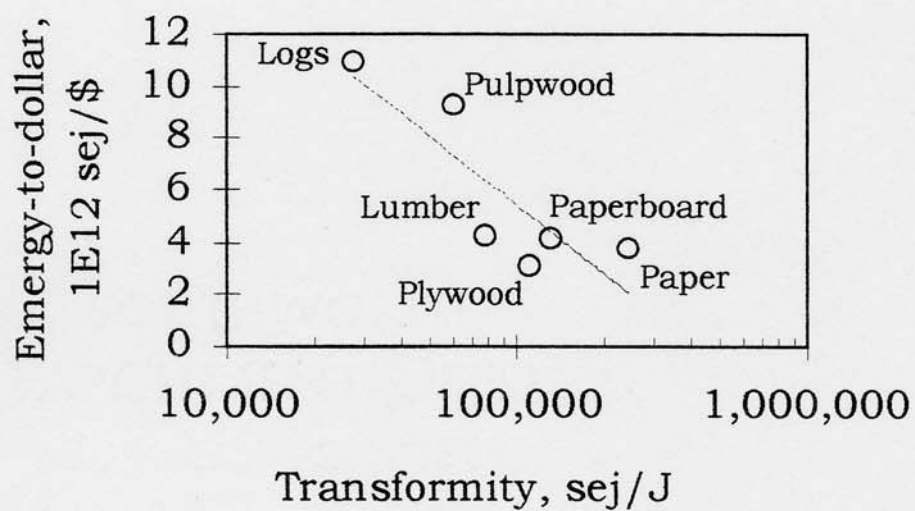

Figure 3-32. The emergy-to-dollar ratio (sej/\$) for major wood products as a function of solar transformity. The emergy-to-\$ ratio is the total emergy flow per a industrial sector divided by the total revenue for that sector.

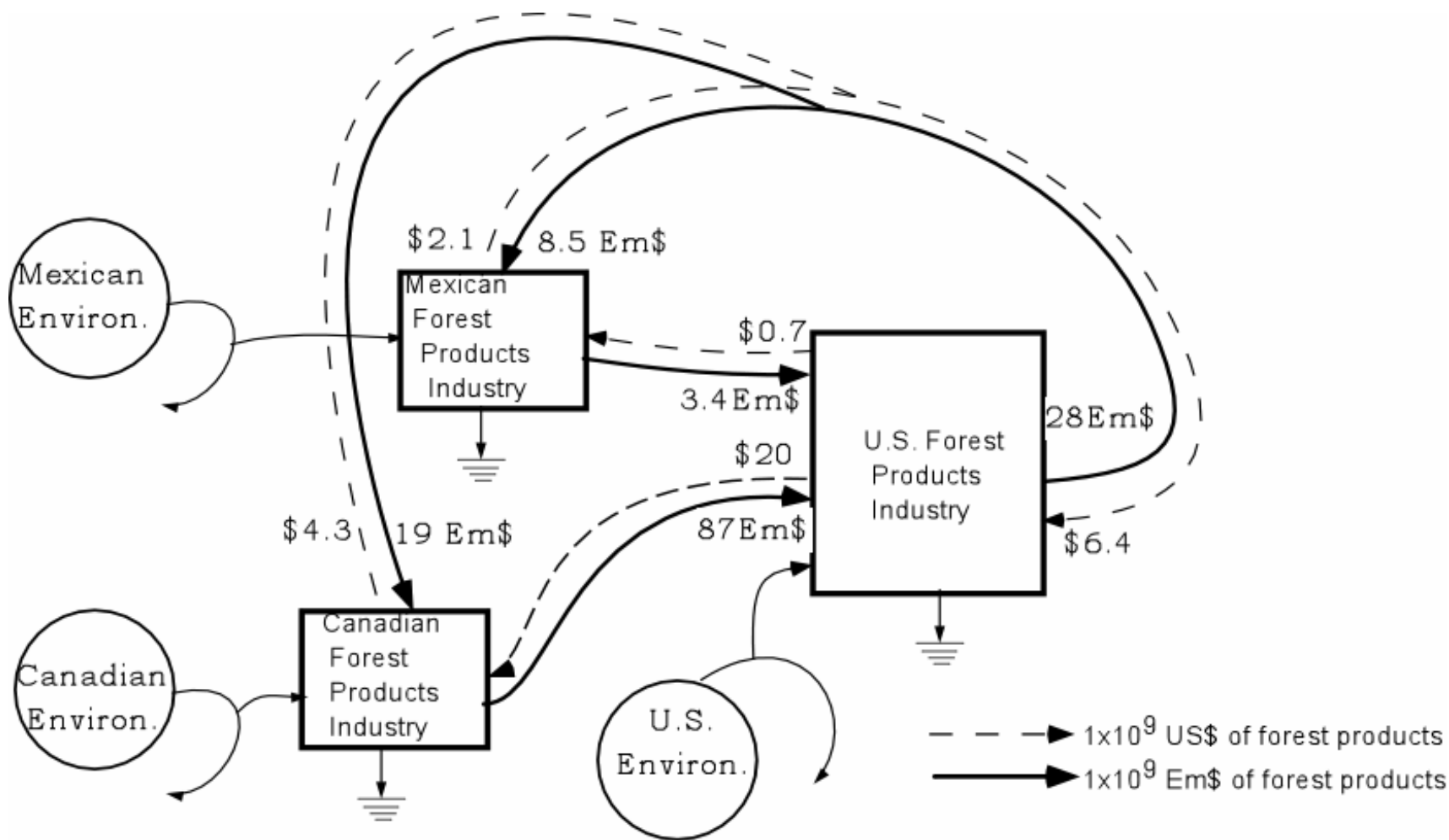

Figure 3-33. Balance of international trade in forest products. Trade in forest products (logs, woopulp, and paper) between the NAFTA (North American Free Trade Agreement) countries (U.S., Canada, and Mexico). Values for the forest products traded are shown in US dollars (\$) and emdollars (Em\$). (See Appendix F for detail by product).

worth 63 E9 Em\$ (950 E20 sej) in 1995. The net surplus was a balance between the net loss to Mexico (5 E9 Em\$/y; the difference between 8.5 E9 Em\$ shipped to Mexico and 3.4 E9 Em\$ received from Mexico) and the net gain from Canada of (68 billion Em\$/y). Trade between Canada and Mexico was not evaluated.

Since the emergy per dollar was higher for wood products (7.6 E12 to 3.6 E12 sej/\$) than the emergy to dollar ratio of the U.S. economy as a whole (1.5 E12 sej/\$), emdollar flows were always greater than the associated dollar flows (Figure 3-33). What looked to be a total trade deficit of \$14.3 billion (US\$) for the United States in dollar terms--a deficit of \$15.7 billion with Canada and a surplus of \$1.4 billion with Mexico (Lyke 1998)--was actually a trade surplus of 63 E9 Em\$. The U.S. received more emergy from Canada and Mexico in the form of wood products than it gave up using its currency.

Figure 3-34 shows exchange matrices (i.e., from:to) by type of forest product traded. Pulp was the most widely traded forest product in terms of emdollars. The U.S. received 1.9 E9 Em\$ (29 E20 sej) from Mexico and 43 E9 Em\$ (650 E20 sej) from Canada, but shipped 6.1 E9 Em\$ (92 E20 sej) to Mexico and 11.7 E9 Em\$ (176 E20 sej) to Canada (Figure 3-34b). The net advantage to the U.S. was 27.6 billion Em\$/y (415 E20 sej/y) for pulp, 30 billion Em\$/y (450 E20 sej/y) for wood logs, and 5 billion Em\$/y (75 E20 sej/y) for paper (Figure 3-34b).

Global Forest Stocks and Consumption

The graph of empower of global tree harvest in Figure 3-35 was constructed using the average solar transformity for wood from the North Carolina analysis (2.1 E4 sej/J). The empower of world tree harvest doubled over the last half of the 20th Century, but has

Value of trade in US\$ (1×10^9) (from Lyke 1998)

		a) Wood logs				b) Pulp				c) Paper				d) All Wood Products						
		To				To				To				To						
		U	M	C	total	U	M	C	total	U	M	C	total	U	M	C	total			
From	U	XX	0.3	7.0	7.3	U	XX	0.4	9.3	9.7	U	XX	0.0	3.3	3.3	U	XX	0.7	19.6	20.3
	M	0.2	XX	XX		M <td>1.3</td> <td>XX</td> <td>XX</td> <td></td> <td>M <td>0.6</td> <td>XX</td> <td>XX</td> <td></td> <td>M <td>2.1</td> <td>XX</td> <td>XX</td> <td></td> </td></td>	1.3	XX	XX		M <td>0.6</td> <td>XX</td> <td>XX</td> <td></td> <td>M <td>2.1</td> <td>XX</td> <td>XX</td> <td></td> </td>	0.6	XX	XX		M <td>2.1</td> <td>XX</td> <td>XX</td> <td></td>	2.1	XX	XX	
	C	1.2	XX	XX		C <td>2.5</td> <td>XX</td> <td>XX</td> <td></td> <td>C <td>0.6</td> <td>XX</td> <td>XX</td> <td></td> <td>C <td>4.3</td> <td>XX</td> <td>XX</td> <td></td> </td></td>	2.5	XX	XX		C <td>0.6</td> <td>XX</td> <td>XX</td> <td></td> <td>C <td>4.3</td> <td>XX</td> <td>XX</td> <td></td> </td>	0.6	XX	XX		C <td>4.3</td> <td>XX</td> <td>XX</td> <td></td>	4.3	XX	XX	
	tot	1.4				tot	3.8				tot	1.2				tot	6.4			

Value of trade in Em\$ (1×10^9)

		e) Wood logs				f) Pulp				g) Paper				h) All Wood Products						
		To				To				To				To						
		U	M	C	total	U	M	C	total	U	M	C	total	U	M	C	total			
From	U	XX	1.0	6.1	7.1	U	XX	6.1	11.7	###	U	XX	1.4	1.4	2.9	U	XX	8.5	19.2	27.7
	M	1.5	XX	XX		M <td>1.9</td> <td>XX</td> <td>XX</td> <td></td> <td>M <td>0.0</td> <td>XX</td> <td>XX</td> <td></td> <td>M <td>3.4</td> <td>XX</td> <td>XX</td> <td></td> </td></td>	1.9	XX	XX		M <td>0.0</td> <td>XX</td> <td>XX</td> <td></td> <td>M <td>3.4</td> <td>XX</td> <td>XX</td> <td></td> </td>	0.0	XX	XX		M <td>3.4</td> <td>XX</td> <td>XX</td> <td></td>	3.4	XX	XX	
	C	35.5	XX	XX		C <td>43.4</td> <td>XX</td> <td>XX</td> <td></td> <td>C <td>7.9</td> <td>XX</td> <td>XX</td> <td></td> <td>C <td>86.8</td> <td>XX</td> <td>XX</td> <td></td> </td></td>	43.4	XX	XX		C <td>7.9</td> <td>XX</td> <td>XX</td> <td></td> <td>C <td>86.8</td> <td>XX</td> <td>XX</td> <td></td> </td>	7.9	XX	XX		C <td>86.8</td> <td>XX</td> <td>XX</td> <td></td>	86.8	XX	XX	
	tot	37.0				tot	45.3				tot	7.9				tot	90.2			
		sej/\$		7.6			sej/\$		7.0			sej/\$		3.6						

Figure 3-34. International trade in forest products between the NAFTA countries (1990). From/to matrices of money exchange for (a) wood logs, (b) pulp, (c) paper, and (d) all wood products; and from/to matrices of emdollar exchange for (e) wood logs, (f) pulp, (g) paper, (h) all wood products. U-United States, M-Mexico, C-Canada, XX not evaluated. Emdollar value of wood product, Em\$ = US\$ x emery-to-dollar ratio per wood product type.

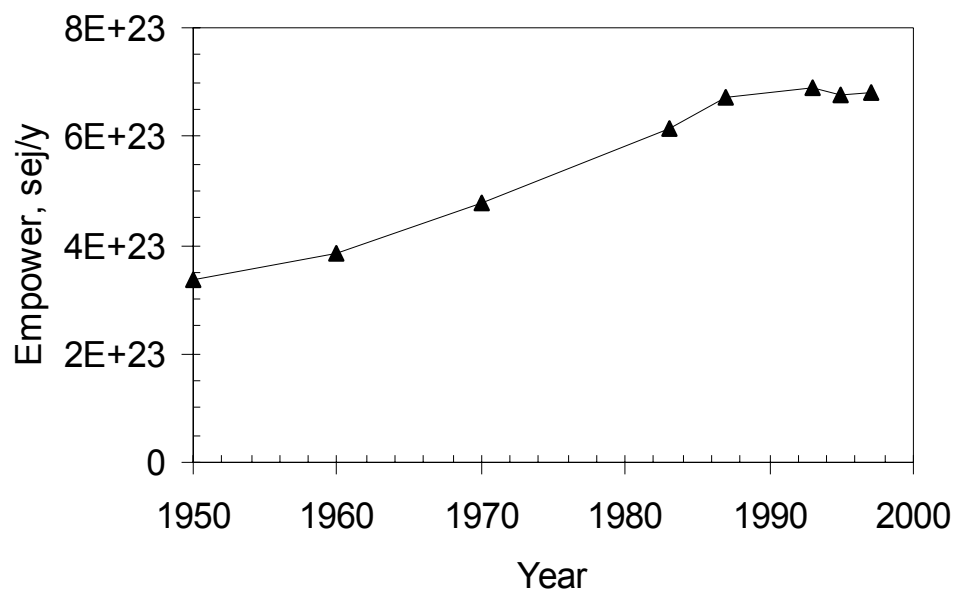

Figure 3-35. Empower of the global forest harvest, 1950-97. The transformity of wood was assumed constant and equal to the transformity of wood growth in North Carolina in the early 1990's ($2.1 \text{ E}4 \text{ sej/J}$).

leveled off at a rate of 6.8 E23 sej/y since 1987. In 1997, 3416 E6 m³ of wood biomass, valued at 6.9 E23 sej (~345 E9 Em\$), was being harvested. In terms of biomass, this was less than 1% of the 400 E9 m³ of timber stock (Mather 1990).

Emergy Indices for Overview of Forested Systems

Indices that related the empower use of environmental and economic energies to each other and the human population were developed for the forested systems of Wine Spring Creek watershed (Table 3-19), Macon County (Table 3-20), and North Carolina (Table 3-21). The indices provide perspective on how the relationship between economy and environment changes with the forested system.

Figure 3-36 displays a map of the emergy investment ratio (purchased to renewable) by county for North Carolina. The index ranged from near zero (0.3) for the coastal county of Hyde to 125 for Mecklenburg County. Much of the emergy investment was in the Piedmont region, centered about Interstate 85 from Charlotte through Greensboro to Raleigh.

Figure 3-37 shows the rank order distributions of North Carolina counties by emergy investment ratio (EIR; purchased to renewable) and by total empower density. The graphs demonstrated the hierarchical organization of the state since well over half of the counties had an emergy investment index and total empower density that was less than the state average. In total, sixty (60) counties had an emergy investment index below 9.1, and sixty-seven (67) had a total empower density less than 14,000 E12 sej/ha/y.

There were definite categories of counties evident from the graphs. For example, Mecklenburg County, home to Charlotte, clearly stands above all others according to its

Table 3-19. Indices using emergy for overview of WSC (1128 ha)

Item	Name of Index	Expression	Value
1	Renewable energy flow	R	1.1E+18
2	Flow from indigenous nonrenewable reserves	N	1.4E+17
3	Flow of imported emergy	F+G+P2I	3.0E+18
4	Total emergy inflows	R+N+F+G+P2I	4.2E+18
5	Total emergy used, U	N0+N1+R+F+G+P2I	4.1E+18
6	Total exported emergy	B	4.3E+18
7	Fraction emergy use derived from home sources	$(N0+N1+R)/U$	0.27
8	Imports minus exports	$(F+G+P2I)-(N2+B+P1E)$	-1.5E+18
9	Export to Imports	$(N2+B)/(F+G+P2I)$	1.49
10	Fraction used, locally renewable	R/U	0.27
11	Fraction of use purchased	$(F+G+P2I)/U$	0.73
12	Fraction imported service	P2I/U	0.05
13	Fraction of use that is free	$(R+N0)/U$	0.27
14	Ratio of concentrated to rural	$(F+G+P2I+N1)/(R+N0)$	2.7E+00
15	Use per m ²	U/(area)	3.6E+11
16	Use per tourist-year	U/tourist-year	1.6E+17
17	Use per visitor	U/# of visitors	3.4E+14
18	Carrying capacity: Number of tourists if only used renewable	(R/U) (# visitors)	3.3E+03
19	Standard of living if current population supported with only renewables	R/(tourist-yr)	4.3E+16
20	Ratio of use to GNP, emergy/dollar ratio	P1=U/GNP	3.3E+13
21	Environmental Loading Ratio (ELR)	$(N0+N1+F+G+P2I)/R$	2.68
22	Use to Import Ratio (UIR)	$U/(F+G+P2I)$	1.37
23	Emergy Sustainability Index (ESI)	(UIR/ELR)	0.51
25	Purchased to indigenous renewable	$(F+G+P2I)/R$	2.68
26	Fraction of Use from Timber	(forest extraction/U)	0.08
27	Fraction of R captured by Forest	(forest growth/R)	1.00

* Letters are given on pathways in Figure 3-20 for reference.

Table 3-20. Indices using emergy for overview of Macon county, N.C. circa 1992

Item Index	Expression	Value
1 Renewable energy flow	R	1.1E+20
2 Flow from indigenous nonrenewable reserves	N	2.7E+20
3 Flow of imported emergy	F+G+P2I	2.7E+20
4 Total emergy inflows	R+N+F+G+P2I	6.5E+20
5 Total emergy used, U	N0+N1+R+F+G+P2I	5.1E+20
6 Total exported emergy	P1E	1.1E+20
7 Fraction emergy use derived from home sources	$(N0+N1+R)/U$	0.46
8 Imports minus exports	$(F+G+P2I)-(N2+B+P1E)$	1.3E+20
9 Export to Imports	$(N2+P1E)/(F+G+P2I)$	0.54
10 Fraction used, locally renewable	R/U	0.22
11 Fraction of use purchased	$(F+G+P2I)/U$	0.54
12 Fraction imported service	P2I/U	0.08
13 Fraction of use that is free	$(R+N0)/U$	0.39
14 Ratio of concentrated to rural	$(F+G+P2I+N1)/(R+N0)$	1.57
15 Use per m ²	U/(area)	3.8E+11
16 Use per person	U/population	2.2E+16
17 Carrying capacity: Use renewables only to remain at present living standard	(R/U) (population)	5106
18 Standard of living if current population supported with only renewables	R/population	4.7E+15
19 Ratio of use to county personal income, emergy/dollar ratio	$P1=U/GNP$	2.0E+12
20 Ratio of electricity to total use	$(e)/U$	0.44
21 Fuel use per person	fuel/population	1.5E+16
22 Environmental Loading Ratio (ELR)	$(N0+N1+F+G+P2I)/R$	3.60
23 Use to import ratio (UIR)	$U/(F+G+P2I)$	1.87
24 Emergy Sustainability Index (ESI)	(UIR/ELR)	0.52
25 Purchased to indigenous renewable	$(F+G+P2I)/R$	2.46
26 Fraction of Use from Forest	$(\text{forest extraction}/U)$	0.14
27 Fraction of R captured by Forest	$(\text{forest growth}/R)$	0.81

* Letters are given on pathways in Figure 3-20 for reference.

Table 3-21. Indices using emergy for overview of North Carolina, ca. 1992.

Item Index	Expression	Value
1 Renewable energy flow	R	1.9E+22
2 Flow from indigenous nonrenewable reserves	N	5.6E+22
3 Flow of imported emergy	F+G+P2I	1.5E+23
4 Total emergy inflows	R+N+F+G+P2I	2.2E+23
5 Total emergy used, U	N0+N1+R+F+G+P2I	1.9E+23
6 Total exported emergy	P1E	6.6E+22
7 Fraction emergy use derived from home sources	$(N0+N1+R)/U$	0.21
8 Imports minus exports	$(F+G+P2I)-(N2+B+P1E)$	4.9E+22
9 Export to Imports	$(N2+P1E)/(F+G+P2I)$	0.67
10 Fraction used, locally renewable	R/U	0.10
11 Fraction of use purchased	$(F+G+P2I)/U$	0.79
12 Fraction imported service	P2I/U	0.12
13 Fraction of use that is free	$(R+N0)/U$	0.21
14 Ratio of concentrated to rural	$(F+G+P2I+N1)/(R+N0)$	3.74
15 Use per m ²	U/(area)	1.39E+12
16 Use per person (6.9 e6 people)	U/population	2.7E+16
17 Carrying capacity: Use renewables only to remain at present living standard	(R/U) (population)	6.8E+05
18 Standard of living if current population supported with only renewables	R/population	2.7E+15
19 Ratio of use to Gross State Product empower per dollar flow	P1=U/GNP	1.2E+12
20 Ratio of electricity to use	(e1)/U	0.29
21 Fuel use per person	fuel/population	1.6E+16
22 Environmental Loading Ratio (ELR)	$(N0+N1+F+G+P2I)/R$	9.14
23 Use to Import Ratio (UIR)	$U/(F+G+P2I)$	1.27
24 Emergy Sustainability Index (ESI)	(UIR/ELR)	0.14
25 Purchased to indigenous renewable	$(F+G+P2I)/R$	8.00
26 Fraction of Use from Forest	(forest extraction/U)	0.09
27 Fraction of R captured by Forest	(forest growth/R)	0.53

* Letters are given on pathways in Figure 3-25 for reference.

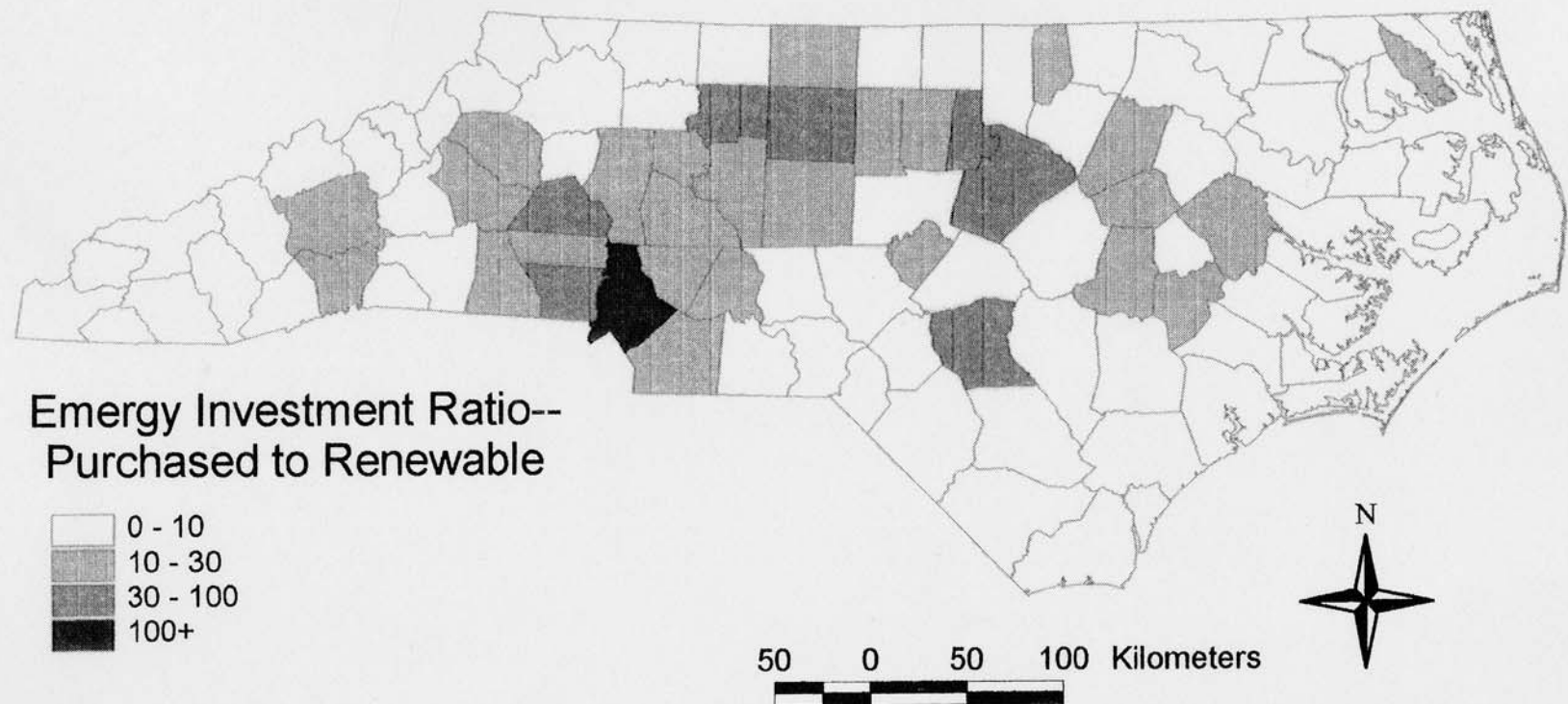

Figure 3-36. Spatial distribution of the energy investment ratio (purchased to renewable) for North Carolina (ca. 1992).

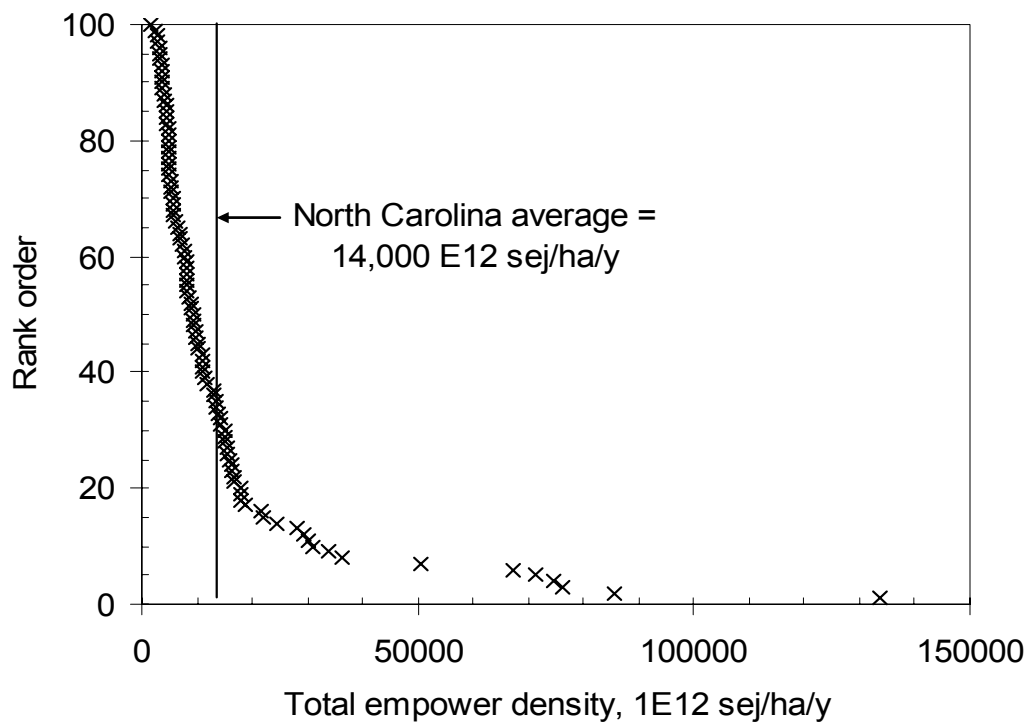
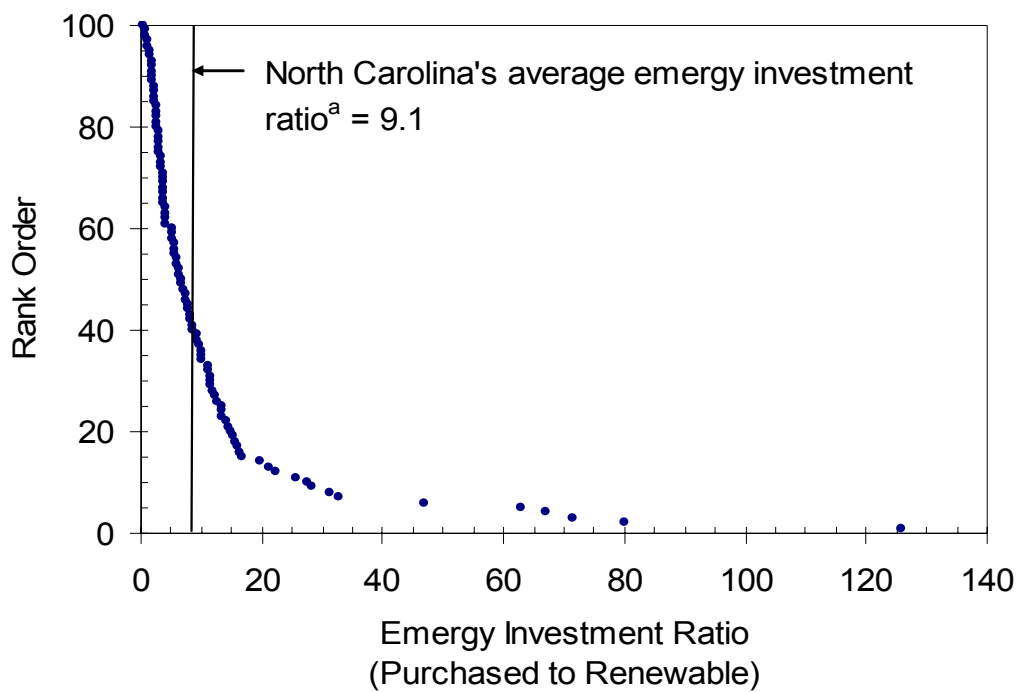

Figure 3-37. Rank order distributions of North Carolina counties by (a) energy investment ratio (purchased to renewable) and (b) total empower density for the year 1992.

EIR and total empower density. It has international recognition as a banking center and is home to two professional sports teams. Next, there was a group of regional centers (Forsyth--Winston-Salem, Durham, Wake--Raleigh, and Guilford--Greensboro) with EIR's ranging from 60 to 80 (Figure 3-37a). There was one county, Gaston, with an EIR of 46 that was set apart from the other counties because it occupied a lone spot on both the EIR graph (Figure 3-37a) and total empower density (Figure 3-37b). It bordered Charlotte and was therefore influenced by that metropolitan center.

There were distinct breaks in both rank order distributions where 80 counties were below and 20 counties above. In Figure 3-37a, an EIR of 15 was the breaking point and in Figure 3-37b, a total empower density of ~20,000 divided the counties into two groupings.

Sensitivity of Emergy Simulation Models

Sensitivity of Emergy and Transformity to Depreciation and Export

Emergy accumulation and transformity were sensitive to rates of storage depreciation and export in the model EMERGYDYN. Coefficients for export and depreciation were changed in EMERGYDYN to determine the sensitivity of the transformity of total organic matter (TOM).

In EMERGYDYN, stored total organic matter (TOM) was lost via two pathways, depreciation and export (see Figure 3-7). Depreciation was assumed to be a process necessary for maintaining the storage, and therefore did not subtract energy from the storage. On the other hand, material lost as export was a loss of emergy. Material exported had the same transformity as the stored organic material.

In Figure 3-38, the total loss (export + depreciation) was held constant at 3%, but the proportion between the export and depreciation was varied. Figure 3-38a shows that the transformity of the stored organic matter increased logarithmically over time, and that the smaller the percentage export was of total loss, the higher the growth rate of the transformity. Figure 3-38b plots transformity of storage as a function of percent export, showing that the smaller transformities result from higher export rates. As export approached 100% of total storage loss (i.e., depreciation approached zero), the transformity of the storage approached the transformity of the incoming material. At an export rate of 100% there was no increase in transformity of the organic matter because there was no time for the organic matter to depreciate and increase its transformity.

Holding depreciation constant at 2.3% of storage, but varying export from 0.1% to 9% of storage resulted in the transformity of the storage decreasing as export increased (Figure 3-38c). Small increases in the export fraction caused large drops in the transformity of the organic matter, especially for increases occurring between 0% and 2%.

Sensitivity of Species Simulation Model EMSPECIES

EMSPECIES was used to simulate the dynamics of tree species abundance for the WSC watershed, and to calculate the energy stored as tree species. The ability of the model to duplicate species area curves for other forested systems was explored.

Notoriously diverse ecosystems, rainforests, were compared.

Tree species-area curves observed for rainforests of Malesia were much steeper than the observed curves for the WSC watershed (Figure 3-39). For EMSPECIES to duplicate the steeper curves, the seed source was increased by a factor of 10 for the curve

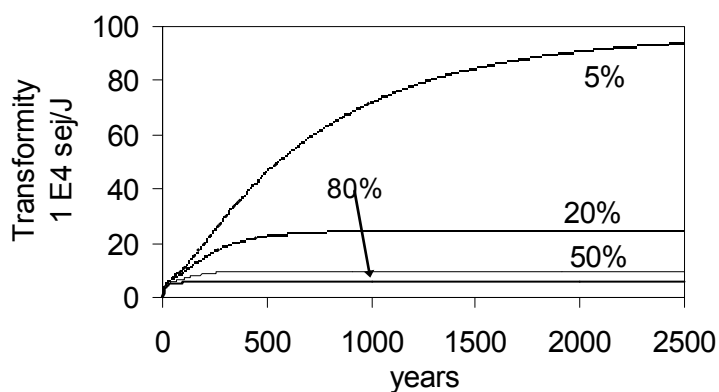

a) time series for levels of export

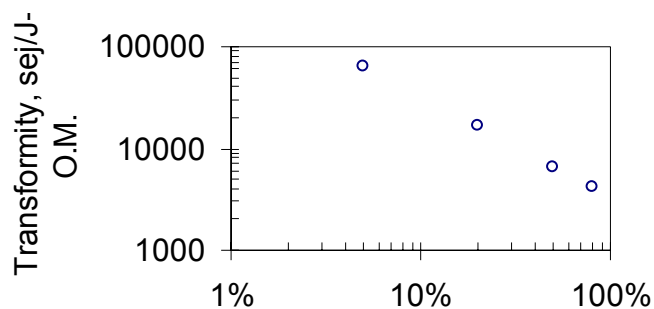

b) export as percent of total loss from storage [steady-state values from (a)]

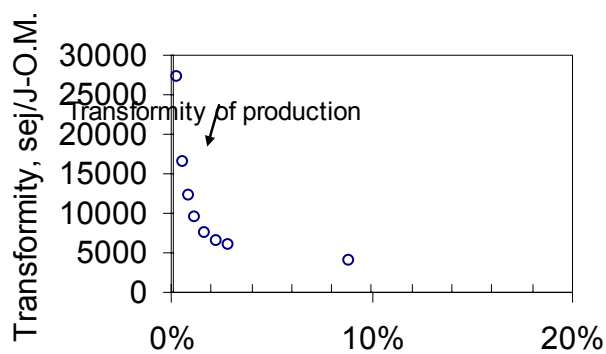

c) percentage of storage exported

Figure 3-38. Transformity of total organic matter (TOM) simulated with EMERGYDYN for the Coweeta watershed. a) time series when total loss (export + depreciation) was held to a constant fraction of 0.03 of storage and the partitioning between export and depreciation was varied, percentages refer to export/total loss; b) steady-state values from (a); c) depreciation was held to a constant fraction of 0.023 of storage while export was varied from 0.006 to 0.094 of storage.

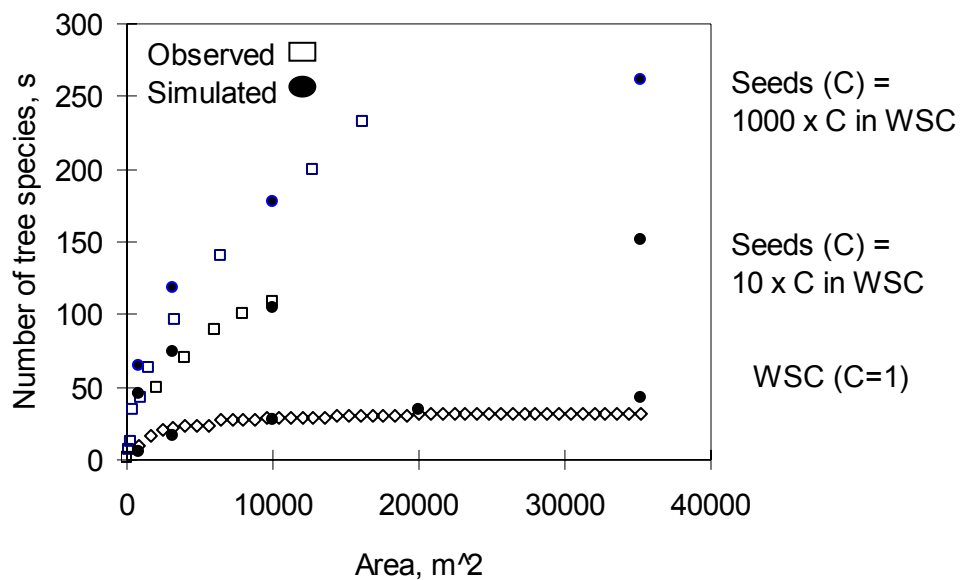

Figure 3-39. Simulation of species area curves for Wine Spring Creek (WSC) and two tropical rainforests. Seed availability was increased by factors of 10 and 1000 times seed availability in WSC (see Figure 3-13a) to duplicate relationships for tropical forests.

appearing in the middle of the graph and by a factor of 1000 for the top curve. For an area of 3.5 ha (35,000 m²), the number of tree species present in the different forested ecosystems ranged over 10-fold from 30 to 320. Thus, according to the EMSPECIES model, tree species abundance measured at one locale, was dependent upon the tree species abundance in the surrounding landscape.

The sensitivity of tree species abundance in EMSPECIES to external seeding indicated that the high elevation (1200m) forest of WSC watershed was limited by the availability of tree species from the surrounding landscape. Malesian rainforests, on the other hand, must have had a much greater supply of tree species from which to recruit, since they had a higher abundance of tree species.

Comparing Curves of Empower-species and Species-area

Using data from the WSC forest, the University of Florida's Arboretum, and the tropical rainforest at East Kalimantan (Malesia), species-area curves were contrasted with empower-species curves.

First, the species-area curves for each forested system were different (Figure 3-40a). The tropical rainforest at East Kalimantan had a much greater number of tree species for the same area. Likewise, the UF Arboretum had a steeper slope than the WSC forest. The UF Arboretum was heavily subsidized with purchased services and resources including weeding, mowing, pruning, fertilizer, irrigation, herbicides and pesticides (see Appendix G for the emergy evaluation of the UF Arboretum).

Although the UF Arboretum had more tree species per unit of area than the WSC forest, on an emergy basis the WSC forest had more tree species for the same empower input (Figure 3-40b). The WSC forest maintained 30 tree species with about 1000 E12

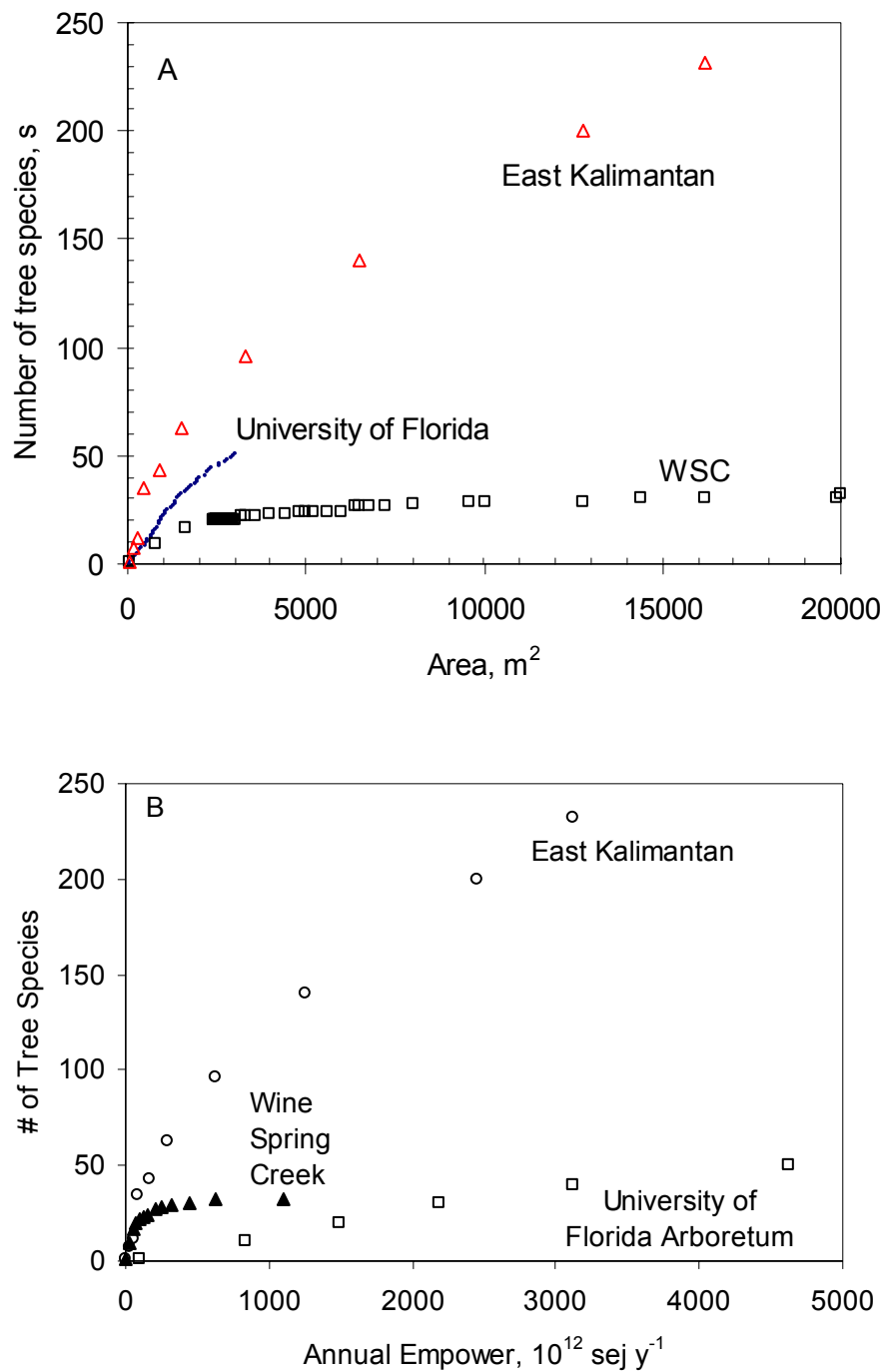

Figure 3-40. Species-area curve (a) and empower-species curve (b) for the forest of Wine Spring Creek (>1200m), the Arboretum at the University of Florida, Gainesville (see Appendix G for energy evaluation), and the tropical rainforest at East Kalimantan, Borneo (Kartiwinata 1984).

sej/y, while the UF Arboretum required 2000 E12 sej/y for the same number of tree species. Thus, the WSC forest was more efficient with its empower at maintaining tree species. The tropical rainforest was even more efficient with its empower, having about 120 tree species for an empower of 1000 E12 sej/y (Figure 3-40b).

Simulating Management Alternatives of Forest Ecosystems

Logging Rotation Schedules and Forest Empower

A ubiquitous question in forest management is how often should the forest be cut. Setting the forest rotation cycle to maximize total empower could be a driving principle. A log harvesting function was added on to the model EMERGYDYN (see Figure 3-7) so that the effects that rotation length had on total forest empower could be investigated. The empower associated with the harvesting effort was based on the emergy analysis of the U.S. forest products industry (see previous section). The same empower per logging cycle (37 E15 sej/ha/cycle) was used for all logging cycles. It was figured by multiplying the emergy investment ratio of logging (EIR = 0.27) by the emergy yield of a 100-yr cutting cycle (1.38 E17 sej/ha/cycle). Harvest magnitude was set at 75% of wood biomass stored.

Figure 3-41 shows the systems diagram, model equations, and time series charts for simulating the wood biomass and emergy properties in EMERGYDYN under rotation cycles of 100-years and 300-years. For a 100-year rotation cycle--a typical management scheme of forest stands in the southern Appalachians--wood biomass reached a value of 269 MT/ha, 91% of its climax value (Figure 3-41b). Its stored emergy at harvest (82 E15 sej/ha) was only 47% of the climax value of 175 E15 sej/ha (152,000 Em\$/ha, compare Figure 3-41b with Figure 3-8). Conversely, logging forest stands when the stored emergy

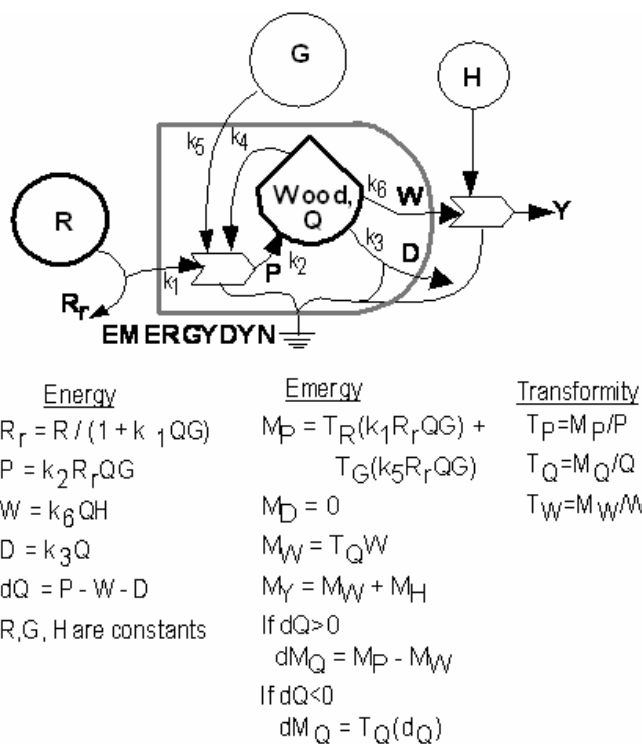

a) Energy systems diagram

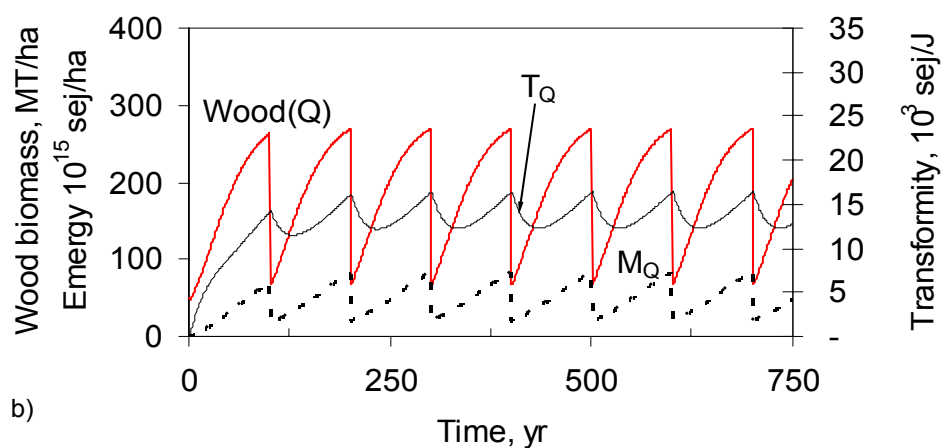

Figure 3-41. The temporal dynamics of the quantity, energy, and transformity of wood biomass simulated in EMERGYDYN (a) for a 100-year rotation (b) and 300-year rotation (c) schedule. (see Figure 3-7 for calibration values).

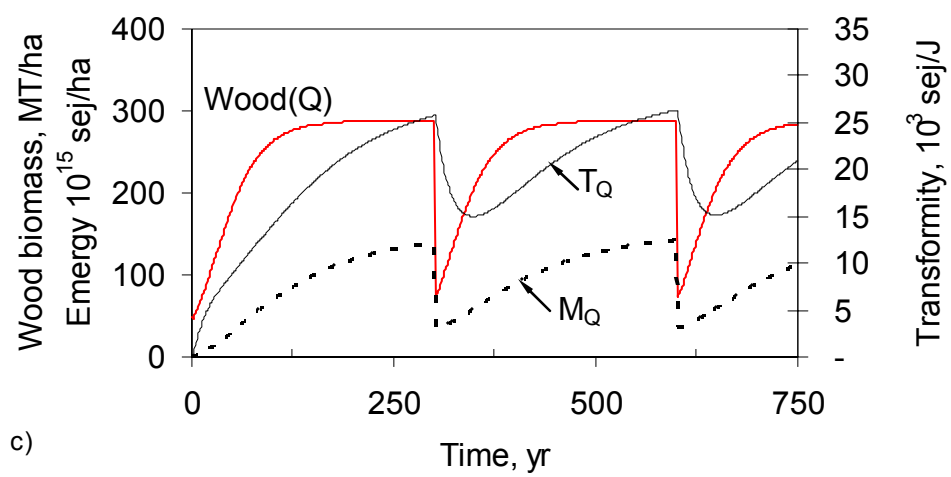

Figure 3-41. continued.

reached 91% of climax (139 E15 sej/ha) resulted in a rotation cycle of 300 years (Figure 3-41c).

Next, Figure 3-42 shows the effects of varying harvest frequency from 10 to 300 years on wood yield, total empower, emergy yield ratio, environmental loading ratio, emergy sustainability index, and the transformity of yield and forest.

According to the simulations, wood yield was maximum for a 25-year cutting cycle, but the value of the harvested wood before adding empower from harvesting, was maximum for a 100-year cycle time (Figure 3-42b).

Figure 3-42c shows that total empower (rain + geologic uplift + harvest) was maximum for a rotation cycle of about 40-years. The total renewable empower input (rain + geologic uplift) increased asymptotically with longer cutting intervals, whereas the empower of harvesting peaked between a cycle times of 20 and 50 years (Figure 3-42c).

The emergy yield ratio increased linearly with cycle time, varying from 1.2 at the 10 y cycle time to 3.9 at 300 y. The environmental loading ratio decreased asymptotically to zero as cycle time increased (Figure 3-42d). The ratio of these two indices, the emergy sustainability index (ESI), increased exponentially with increased cycle time (Figure 3-42e). An index comparable to the ESI, the fraction of yield which was renewable emergy, had an opposing relationship; it increased asymptotically toward 80% as cutting frequency decreased (Figure 3-42e).

The average transformity of the forest and the mean transformity of the yield increased with longer cycle time (Figure 3-42f). Of course, the transformity of the yield

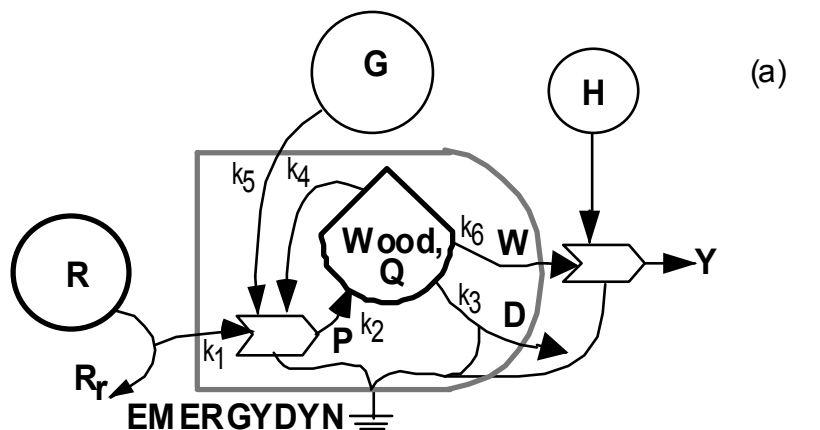

<u>Energy</u>	<u>Energy</u>	<u>Transformity</u>
$R_r = R / (1 + k_1 QG)$	$M_P = T_R(k_1 R_r QG) + T_G(k_5 R_r QG)$	$T_P = M_P / P$
$P = k_2 R_r QG$	$M_D = 0$	$T_Q = M_Q / Q$
$W = k_6 QH$	$M_W = T_Q W$	$T_W = M_W / W$
$D = k_3 Q$	$M_Y = M_W + M_H$	
$dQ = P - W - D$	If $dQ > 0$ $dM_Q = M_P - M_W$	
R, G, H are constants	If $dQ < 0$ $dM_Q = T_Q(dQ)$	

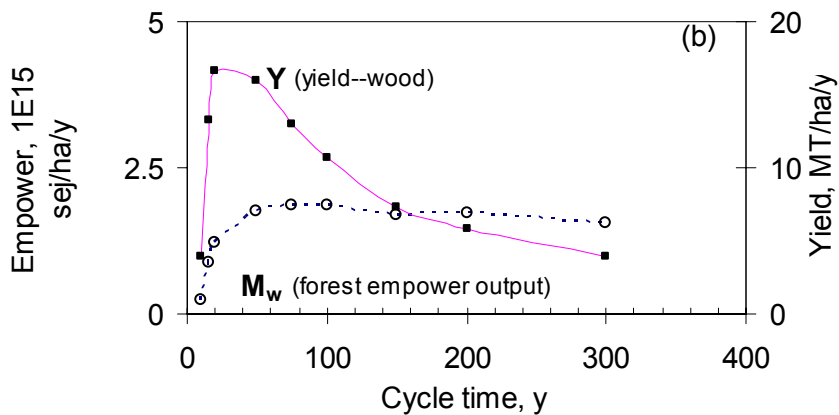

Figure 3-42. Simulated steady-state values of the response of forest energy to frequency of harvest. Energy systems diagram with energy and energy equations (a), wood yield & energy of wood yield (b), energy inputs (c), energy yield ratio & environmental loading ratio (d), renewable fraction in yield & energy sustainability index (e), and transformity of yield and transformity of forest (f).

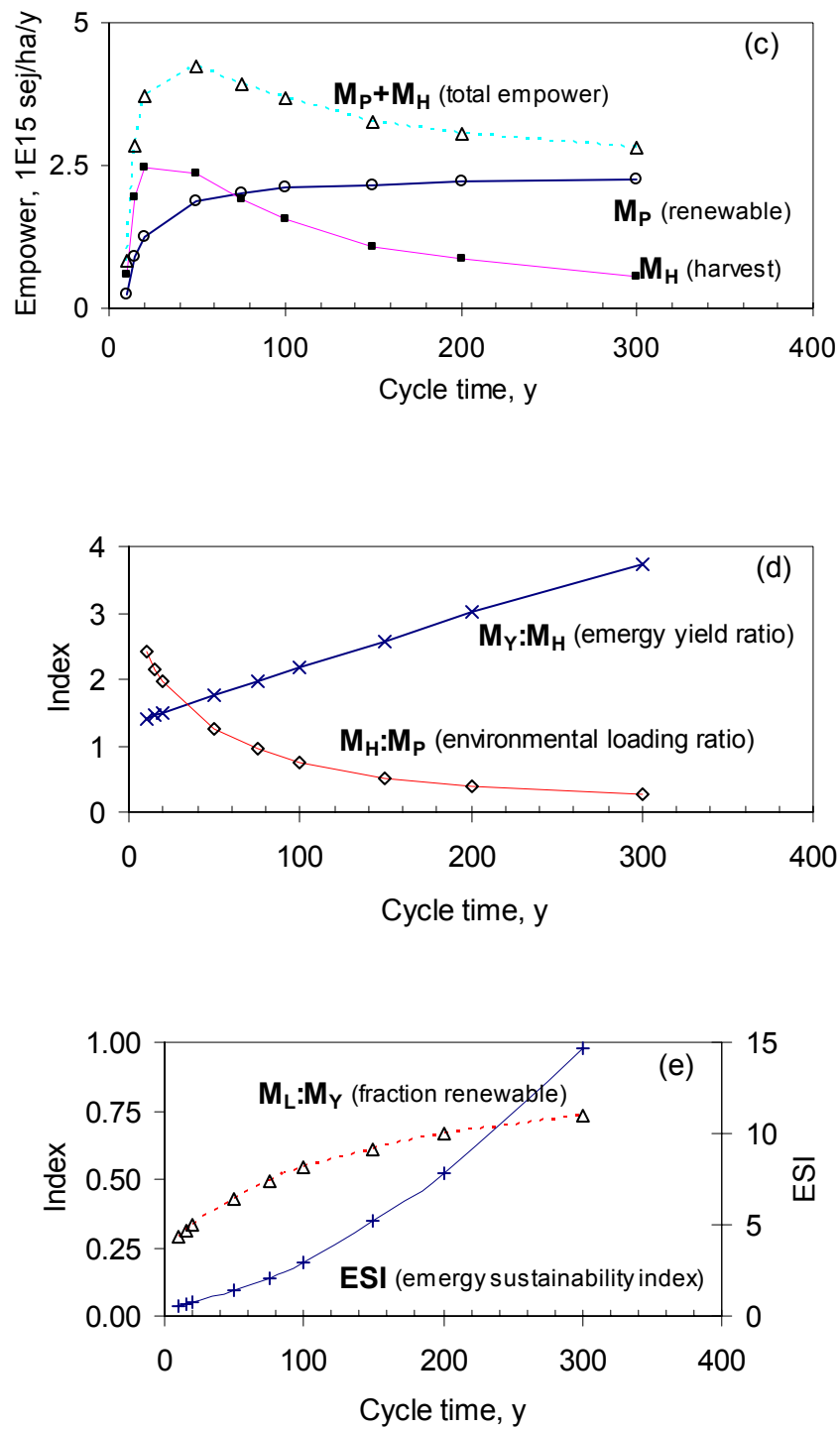

Figure 3-42. continued.

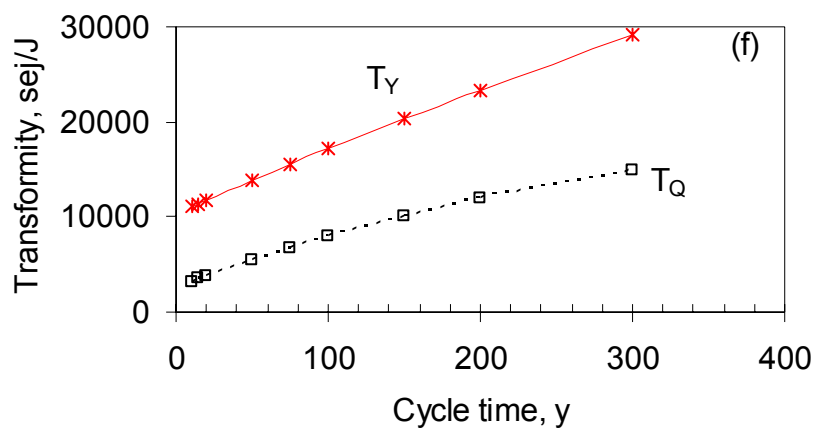

Figure 3-42. continued.

was always the greater of the two because it was wood taken from the forest near the peak of its transformity.

A Model for Simulating the Empower of Multiple Forest Benefits

Forestry management can no longer afford to be solely concerned with maximizing timber yield. The importance of the ecological and recreational services, and other benefits must be recognized. Therefore, a crucial question to address is what combination of forest services (e.g., timber, recreation, ecological) maximizes the total empower on a sustainable basis. By placing all benefits in terms of emergy, all the benefits can be compared quantitatively. Here, the model MULTIBEN was developed (Figure 3-43a) to compare the multiple forest benefits given varying levels of investment in each activity.

Figure 3-43a shows the systems diagram of the MULTIBEN model with the energy and emergy equations. In this simplified model, forest production was a function of the environmental inputs of rain and geologic uplift, and there were only three forest products exported. Two exports (recreation and timber) required an economic investment and one (ecological services) was provided free without any investment. The forest's reserve of organic matter and structure were diminished to supply each forest benefit to society

In Figures 3-43b and 3-43c the empower of each forest benefit as well as the total was plotted as a function of the energy invested in recreation. In this case, the level of investment in timber harvesting was held constant at its present-day value while the recreation intensity factor was varied from 0.5 to 10 in Figure 3-43b and 0.5 to 500 in Figure 3-43c.

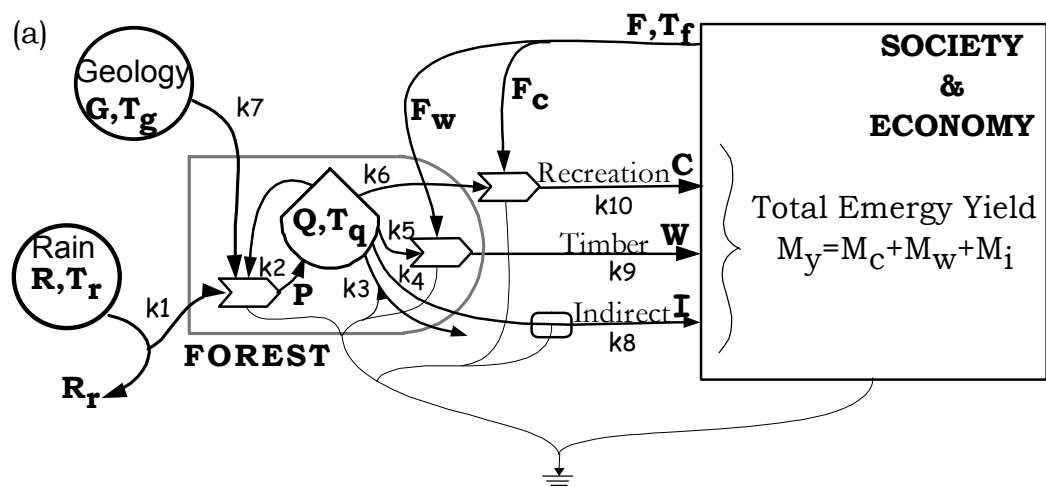

Energy & material equations:

$$R_r = R / (1 + k_1 QG)$$

$$dQ/dt = k_2 R_r QG - k_3 Q - k_4 Q - k_5 Q F_t - k_6 Q F_c$$

$$I = k_8 Q$$

$$W = k_9 Q F_w$$

$$C = k_{10} Q F_c$$

$$P = k_2 R_r QG$$

Emergy equations:

$$M_p = T_r (k_1 R_r G Q) + T_g (k_7 R_r G Q)$$

$$M_c = T_f F_c + T_q (k_6 Q F_c)$$

$$M_w = T_f F_w + T_q (k_5 Q F_t)$$

$$M_i = T_q (k_4 Q)$$

$$M_y = M_c + M_w + M_i$$

$$\text{If } dQ/dt > 0$$

$$dM_q/dt = M_p - T_q * (k_4 Q + k_5 Q F_w + k_6 Q F_c)$$

$$\text{If } dQ/dt < 0$$

$$dM_q/dt = T_q * (dQ/dt)$$

$$T_q = M_q / Q$$

Figure 3-43. MULTIBEN, a model for simulating the empower of multiple forest benefits given different management scenarios. Abbreviations: R, rainfall; G, geologic uplift; Q, total organic matter including wood; P, production of organic matter; F_w, F_c, feedbacks from the economy used to capture Q for timber and recreation, respectively; T_r, T_g, T_q, T_f are transformities of respective energy sources; C, recreated people; W, timber; I, ecological services; M_c, emergy of recreated people; M_w, emergy of harvested timber; M_i, emergy of ecological services; M_y, total emergy yield.

a) systems diagram with energy and emergy equations, b) model output--empower of recreation, timber, ecological services, and total as function of investment in recreation (F_c), c) same graph as in (b) except the x-axis was extended to F_c = 500 so that the maximum total empower could be seen, d) environmental loading ratio and emergy yield ratio as functions of recreation investment.

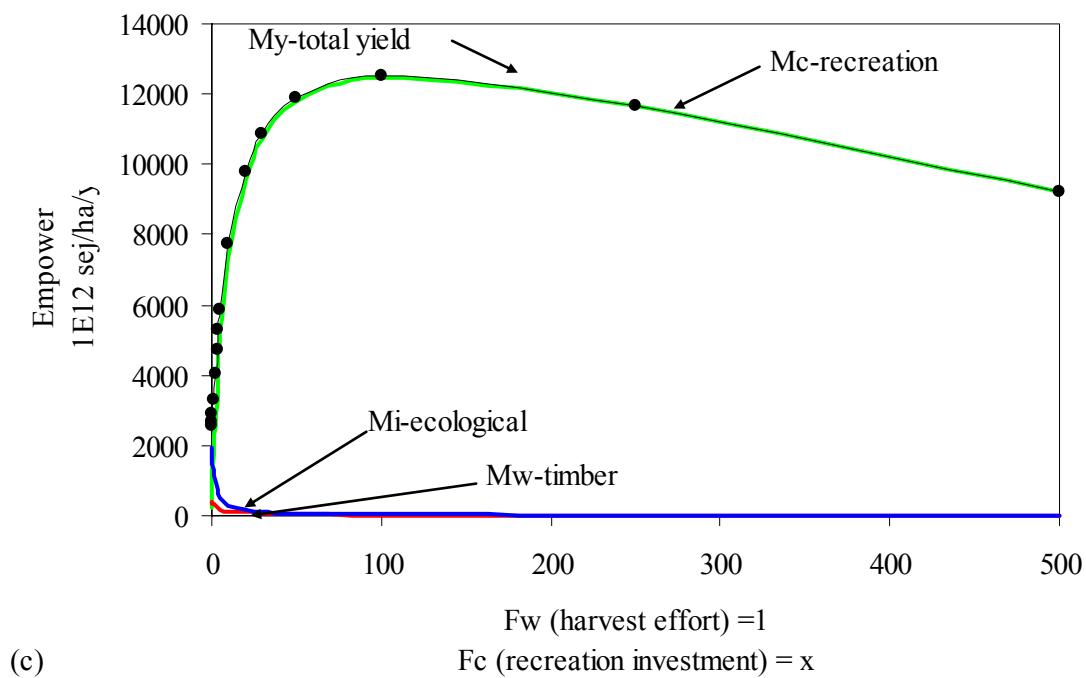
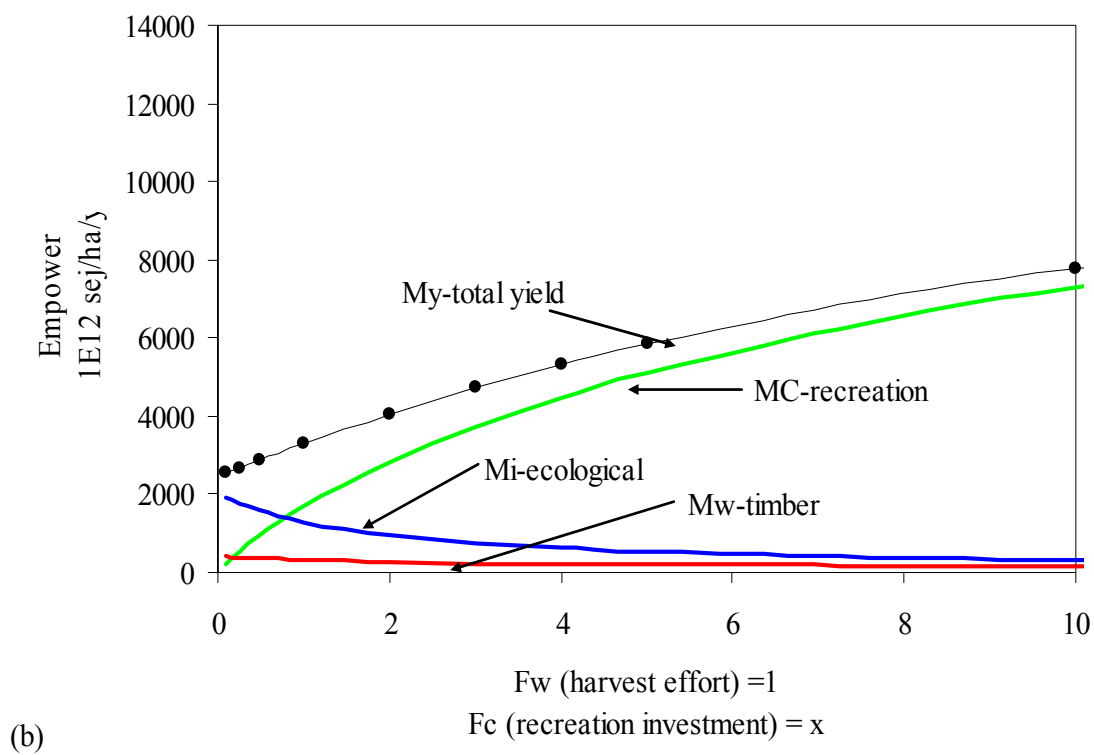

Figure 3-43. continued.

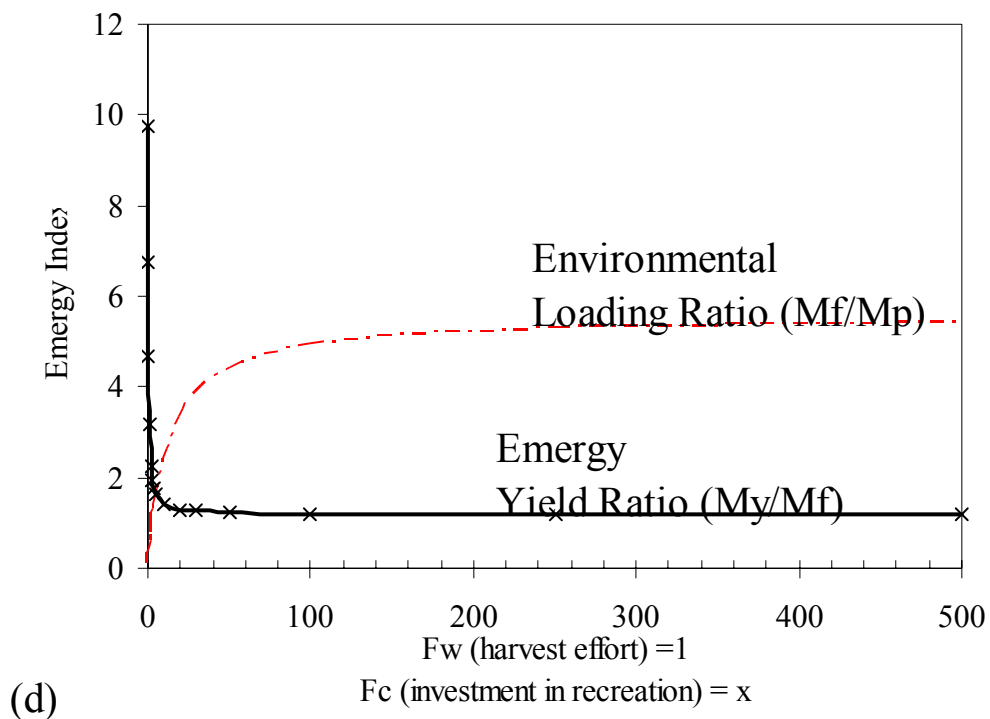

Figure 3-43. continued.

The graph in Figure 3-43b shows that the emergy yield of recreation and total benefits increased at a decelerating rate, while the timber and ecological services decreased to near zero by the time recreation intensity was 10 times present levels. Thus, there was a trade-off between each benefit since some of the forest resources were required to provide each export.

Figure 3-43c plots the same graph as in Figure 3-43b except that the x-axis is extended to reveal the negative marginal rate of return of investing in recreation. The total empower was maximum at 1200 E12 sej/ha/y when the investment in recreation was 100 (100 times its present level). However, at this level of investment, the ecological amenities and timber products were not provided.

Figure 3-43d shows the environmental loading ratio and emergy yield ratio as a function of the investment in recreation. The environmental loading ratio increased asymptotically to five (5) as recreation intensity was heightened. The emergy yield ratio behaved exactly opposite; it decreased rapidly and asymptotically to one (1).

MULTIBEN is shown in Figure 3-44a with the sustainability sub-module and equations. The sustainability product, S , is a function of recreation, timber, and ecological services. The rationale for the sustainability product is that all three individual forest exports are required for a properly functioning society and economy. A deficiency in any single export may limit the sustainability product while an excess of one may go unused, or it is simply a luxury that is not used in a productive process. In other words, there is an optimum mix of the forest exports that is sustainable. Emergy is associated with S , the sustainability product, in proportion to the amount each forest product is used to make S .

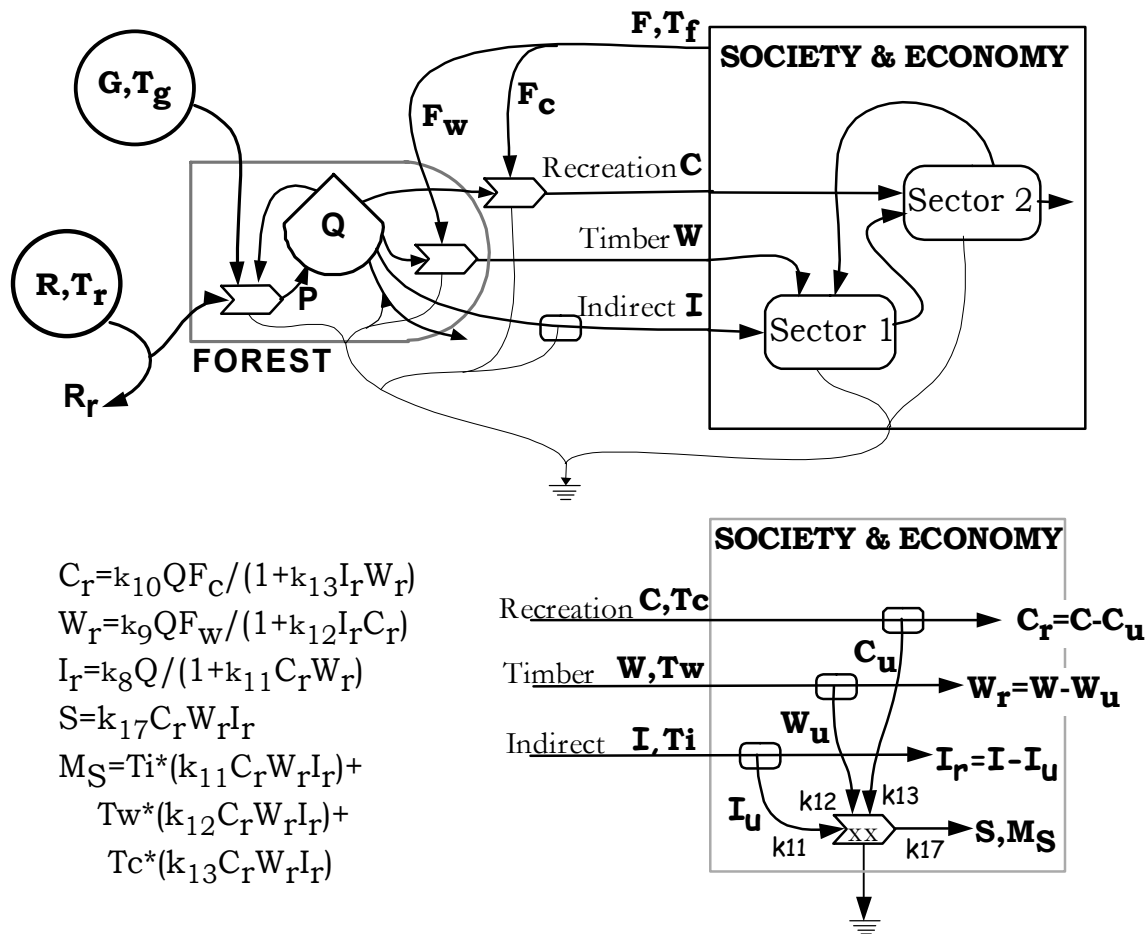

(a)

Figure 3-44. Model MULTIBEN with sub-module added for simulating the sustainability of providing multiple benefits. Abbreviations (see Figure 3-44 for others): S, sustainable product yield to the regional economy based on the availability of C_r, W_r, & I_r; C_u, W_u, & I_u, the used fractions of C, W, & I; C_r, W_r, & I_r, the remaining (unused) fractions of C, W, & I; M_s, the emergy yield in proportion to S. (a) Systems diagram with supplemental equations for calculating S (see Figure 3-44 for more on equations); (b) S as a function of investment in recreation and timber harvesting; (c) S/F, effective emergy yield ratio as a function of investment in recreation and Y/S, index of imbalance.

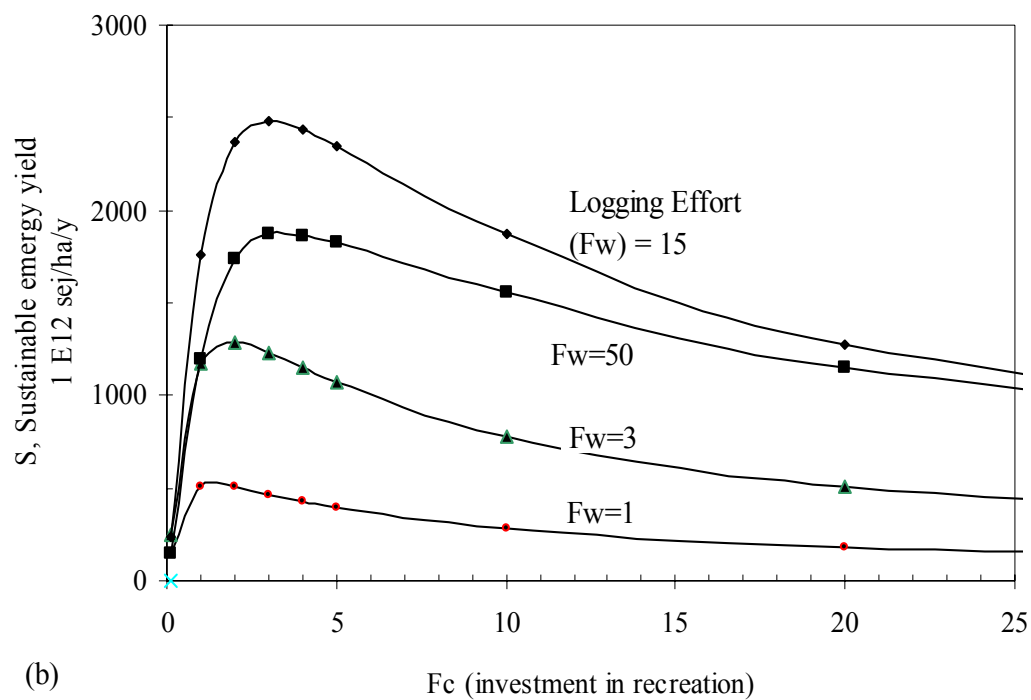

(b)

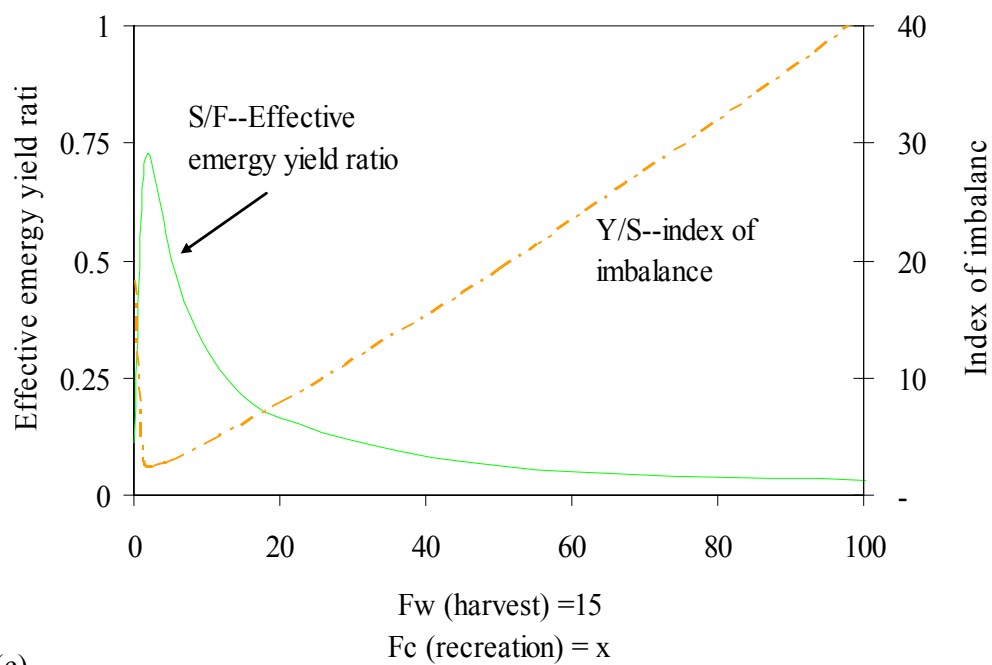

(c)

Figure 3-44. continued.

In Figure 3-44b, the empower of the sustainability product (M_s) is plotted as a function of the investment in recreation for various levels of timber harvesting. For each level of timber harvesting, there existed a maximum value for M_s . For example, at a timbering rate of 15 (i.e., 15 times the present day rate), the maximum empower of S (M_s) was 2500 E12 sej/ha/y at an investment in recreation of three (3) times the present-day rate. For lower levels of investment in timber harvesting, the empower of the sustainability product (M_s) had a lower maximum at lower levels of investment in recreation.

Figure 3-44c shows the sustainable energy yield ratio (S/F), as a function of investment in recreation. S/F had a maximum of 0.75 when the investment in recreation was three (3) times the present-day rate and the investment in timber harvesting was fifteen (15) times current levels.

Figure 3-44c also shows the index of imbalance (Y/S) which is the ratio of the actual yield from the forest to the sustainable yield. A value of one (1) indicates that the yield is in balance with what is sustainable. A value greater than one (1) measures how much greater the actual yield is than the sustainable level. A high index of imbalance indicates that there is luxury uptake of one of the forest products and that the matching of outputs is poor. For example, if recreation were produced in excess in the Wine Spring Creek watershed, then timber and ecological services were likely produced in deficient quantities. To make up for the deficiency, timber and ecological services need to be produced elsewhere, or the recreation needs to be decreased at the Wine Spring Creek watershed.

CHAPTER 4 DISCUSSION

Summary

The Significance of Environmental Driving Energies to the Southern Appalachians

The forested watersheds of the Southern Appalachian Mountains are driven by a spectrum of environmental and economic energies. In this dissertation, it was found that the rates of energy contribution by the environmental energies of wind kinetics, water vapor saturation deficit, rainfall, and geologic uplift were similar to each other (see Figure 3-3). Direct solar radiation on the other hand, provided energy at one-tenth the rate of the other driving energies. Rates of energy contribution to the Wine Spring Creek (WSC) watershed, from fuels, logging activities, tourists, U.S. Forest Service management, and other economic inputs were similar to the rates of environmental empower.

Values of Forests in the Southern Appalachian Mountains

Benefits provided by the forested watersheds of the Southern Appalachian Mountains were determined based on the rate of use of energy from environmental and economic sources. The Wine Spring Creek watershed contributed wealth to the economy at an annual rate of 4300 Em\$ per hectare of watershed (see Figure 4-1). In terms of energy, the four most significant exports were stream water discharge, research information, recreated people, and timber (see Figure 4-1). The balanced values of the

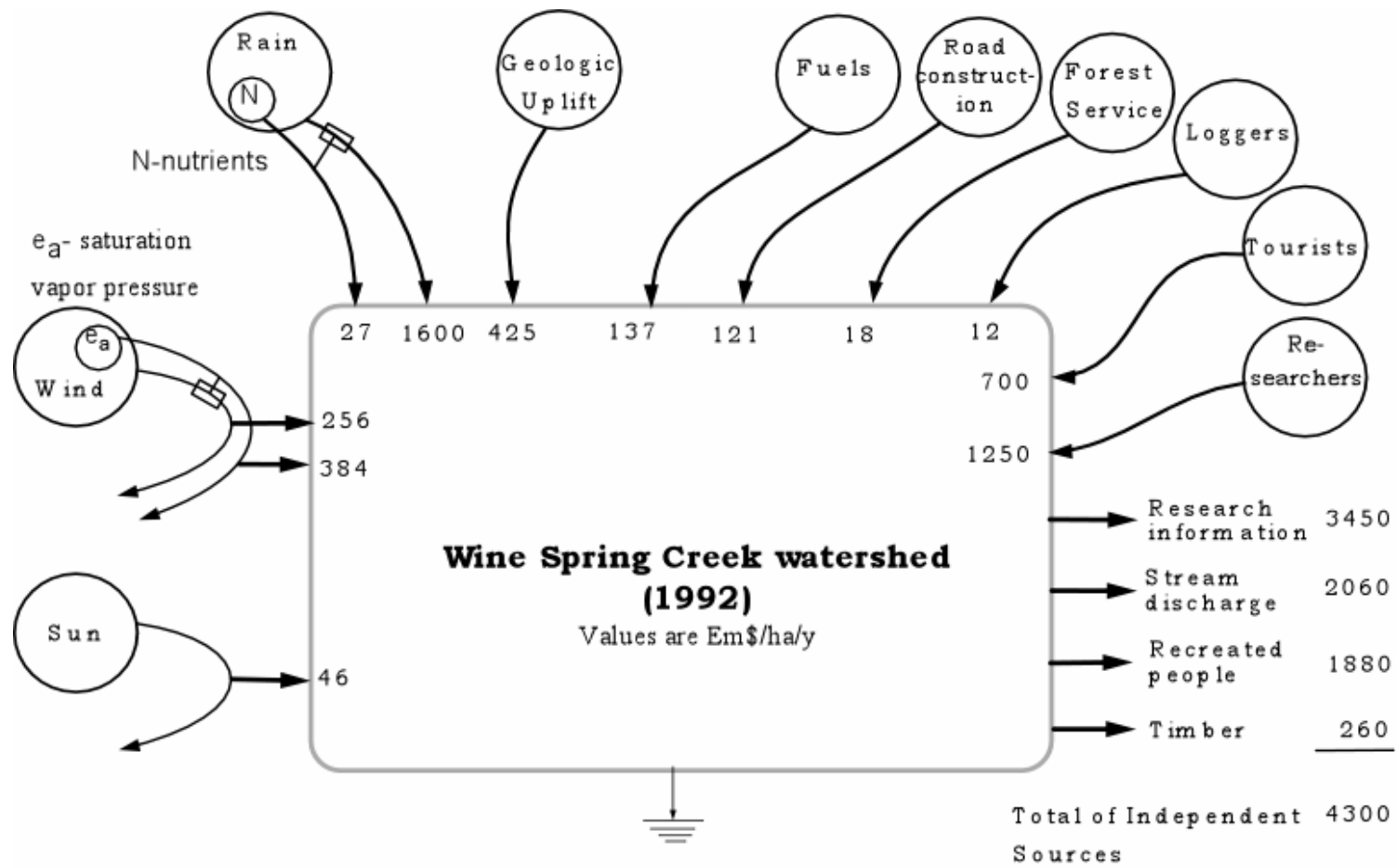

Figure 4-1. Summary diagram of the emdollar value of the forcing factors and products of the Wine Spring Creek watershed.

exports indicated that the multiple-use management strategy maximized total empower in the watershed.

The development and maintenance of biogeochemical cycles is an important service provided by ecosystems. As an indication of this free service, the emergy required to maintain the calcium cycle of the Coweeta watershed was determined. It was found that $27 \text{ E}9 \text{ sej/y}$ were needed to cycle each gram of calcium annually within the watershed, which translated to $25 \text{ Em\$/kg-Ca}$ based on a driving empower of $2240 \text{ Em\$/ha/y}$ (see Figure 3-5c).

Emergy values calculated for the main stores of material, energy, and information (see Table 3-4) showed that tree species represented the largest accumulation of emergy. Saprolite (regolith) was the second largest storage of emergy and an order of magnitude less than tree species. Emergy stored as total organic matter (live & dead) was next, followed by calcium, wood, and soil moisture.

The Importance of Forested Systems and Other Ecosystems to Economic Production

As the scale of analysis shifted from the Southern Appalachian Mountain watersheds to the economies of Macon County and North Carolina, the contribution of emergy from environmental sources decreased relative to that derived from economic sources, but remained important to each system. Based on emergy indices, the three forested systems of Wine Spring Creek, Macon County, and North Carolina were not self-sustaining. They each depended upon outside resources, especially fossil fuels, for significant amounts of their emergy. North Carolina derived only 21% of its emergy from within its own boundaries (Table 3-21). Macon County, which produced 46% of its

own energy (Table 3-20), was more self-reliant than the Wine Spring Creek watershed with indigenous resources providing 27% (Table 3-19).

Forestry and forested systems played significant roles in each ecological-economic system. Timber extraction provided 3% of the world's energy use, 9% of North Carolina's (Table 3-21), 14% of Macon County's (Table 3-20), and 8% of Wine Spring Creek's (Tables 3-19). Forests were responsible for capturing the majority of the renewable, environmental energy in North Carolina, Macon County, and the Wine Spring Creek watershed because they covered the majority of the land area. In North Carolina forests were responsible for capturing 53% of the renewable, environmental energy input; in Macon County forests captured 81%; and in the Wine Spring Creek watershed forests captured 100%. Globally, forests were estimated to capture between 10 and 15% of the renewable energy.

Incorporating the Temporal and Spatial Dynamics of Energy and Transformity into Energy Evaluations

The transformity and energy of forest storages were calculated with temporally dynamic computer simulation models (Figures 3-7, 3-9, 3-11). The transformity and accumulated energy of a storage lagged the energy and material of the forest reserves in the models, requiring more time to reach a plateau (see Figures 3-8, 3-10, and 3-12).

A simple spatial model was developed which converged the energy contributed by rain and mountain uplift to the lower elevation land and ultimately to the stream channel. This was a modification to Romitelli's (1997) suggested methodology. The model was applied to the Wine Spring Creek watershed to quantify how the energy of the streams increased downstream (see Figure 3-14). According to the area-based

frequency distribution of empower density, a large portion of the watershed with low empower densities ($<5 \text{ E16 sej/ha/y}$) was required to make a small area of high empower density ($>1\text{E17 sej/ha/y}$) (see Figure 3-15).

Management Policies

To fully appreciate the social and economic benefits of forest lands, the new philosophy of ecosystem management must take a systems viewpoint which can realize the importance of the multiple forcing factors over varying scales of space and time, and can relate these forcing factors to the services and products. Only then will we be able to understand the physical, material and energy basis of forest wealth and the consequences of management decisions.

Evaluation of the MULTIBEN model highlighted the synergism that exists between the various products of the forest. Over a small geographical scale and short time horizon it may seem that managing the forest for a single output is the wisest choice. Results in Figure 3-43 did show that forest empower could be maximized at an intermediate intensity of outside investment, but that only one product was produced; recreation was provided at the exclusion of ecological services and timber products. A better management strategy, one which appreciates the trade-offs between the multiple benefits, was evaluated with the sustainability product function in the MULTIBEN model. Maximum empower from multiple forest benefits was achieved at an intermediate intensity of outside investment and an even mix of forest products (see Figure 3-44).

New Solar Transformities

Table 4-1 shows a list of the solar transformities calculated in this dissertation.

Table 4-1. Summary of solar transformities calculated in this dissertation.

Item	Energy Transformity, per mass,		Source
	sej/J	sej/g	
Environmental Energies			
Atmospheric water vapor saturation deficit	5.9E+02		Table C-3 assumed equal to earth cycle
Atmospheric deposition		1.0E+09	
Altitude dependent earth deep heat	variable		Table E-1
Altitude dependent mountain erosion		variable	Table E-2
Internal processes at Coweeta WS18			
Rock weathering		4.6E+09	Table 3-1
Forest calcium cycle (100 yr old forest)		2.7E+10	"
Wood growth	2.1E+04		"
Net primary production, aboveground	1.1E+04		"
Net primary production, roots only	1.5E+04		"
Litterfall	2.0E+04		"
Stream discharge, chemical potential	4.4E+04		"
Outputs from Wine Spring Creek watershed			
Recreated people	2.4E+07		Table 3-2
Research information	3.1E+12		"
Stream discharge, chemical potential	3.2E+04		"
Timber, harvested w/ services	7.0E+04		"
Forest products of U.S.			
Forest growth, average for North Carolina	2.1E+04		Table 3-12
Logs delivered to sawmill	2.7E+04		Table 3-13
Woodpulp	6.0E+04		Table 3-14
Paper board	1.3E+05		Table 3-15
Paper	2.4E+05		Table 3-16
Plywood	1.1E+05		Table 3-17
Lumber	7.9E+04		Table 3-18
Storages at WS18 Coweeta			
Soil moisture, chemical potential	5.2E+04		Table 3-4
Wood	3.0E+04		Table 3-4/Figure 3-8
Total organic matter	2.5E+04		Table 3-4
Saprolite		7.9E+09	Table 3-4/Figure 3-12

Energy of Southern Appalachian Watersheds

Environmental Driving Energies and Empower Spectra

Environmental energies that drive development of forested watersheds in the Southern Appalachian Mountains were shown to have similar empower (Figure 3-3). In the Wine Spring Creek watershed, the contribution of empower from the water vapor deficit, wind kinetics, rain geopotential, rain chemical potential and deep heat ranged narrowly between 280 E12 and 520 E12 sej/ha/y. Does the fact that the empower of all environmental inputs were nearly equal indicate that the forested watershed self-organized so that all inputs are equally limiting? In the case of the Wine Spring Creek watershed, sunlight contributed the least amount of empower (50 E12 sej/ha/y) of the energy forms evaluated, which may indicate that it was the limiting factor.

New perspectives concerning the relationships between driving energies and their role in organizing the architecture of the forested watersheds may be gained from analyzing the empower spectra. With the empower spectra, an ecosystems unique pattern of use of different energy forms is described graphically. The spectra quantitatively describe the setting in which the ecosystem operates. For example, differences in the empower spectra of the two Southern Appalachian Mountains watersheds indicated that use of chemical potential energy of water was more important in the Coweeta basin (i.e., transpiration was higher), but the use of water's geopotential energy dominated in the Wine Spring Creek (Wine Spring Creek) watershed (Figure 3-3). The ratio of the empower of chemical energy used (evapotranspiration) to the empower of geopotential energy used (water runoff) was 5.7 (850/150 E12 sej/ha/y) for WS18 of the Coweeta basin, but only 0.83 (500/600 E12 sej/ha/y) for the Wine Spring Creek basin. This fits

with Romitelli's (1997) observation that this ratio increased as altitude decreased. That is, in terms of energy, geological productivity was greater than biological productivity in the mountain headwater streams, but that the dominant form of energy use shifted downstream.

The chemical to geopotential ratio of water use is but one energy ratio that could be measured. Other ratios, developed from the empower spectra, may provide vital information about the general properties of system energetics. The ratio of vapor deficit use to sunlight was calculated for the Southern Appalachian watersheds. Coweeta's index of vapor deficit use to sunlight was 15 (750/50 E12 sej/ha/y) while it was 8 (400/50 E12 sej/ha/y) for the Wine Spring Creek basin. Another energy index calculated was geologic input (deep heat) to vapor deficit use. This index was 0.65 for Coweeta's ws18 and 1.12 for the Wine Spring Creek. Therefore, the change of both energy indices with altitude (mid-points for the basins were 860m for Coweeta's ws18 and 1320m for Wine Spring Creek) demonstrated that the proportional contribution from the forms of energy adjusted to the changing availability of energy forms.

These indices have properties analogous to the energy investment ratio that has been used often to indicate the intensity at which the environment was being used by an economic activity. Values for the energy investment index were often in the range of 1 to 100. Values near one (1) have typically been found for forest lands (Odum and Odum 1987, Doherty 1995), while urban landscapes have been observed to have values greater than 100 (Mecklenburg County, N.C., this study). Since the transformity of the vapor deficit (590 sej/J) was higher than sunlight (1 sej/J), the vapor deficit was the high quality energy that was matched to the lower quality energy, sunlight. Most remarkable was the

fact that the ratio of vapor deficit use to sunlight was in the realm of an order of magnitude (10).

Emdollar Values of Forest Processes, Exports, and Storages

The Wine Spring Creek watershed contributed wealth to the economy at the annual rate of 4300 Em\$ per hectare of watershed. This was the combination of environmental and imported energies. The role of the watershed as a research facility was of greatest value (3450 Em\$/ha; see Table 3-2). Water yield was second at 2060 Em\$/ha, while recreational value was 1880 Em\$/ha. Much of the basin has been excluded from timbering in order to maintain high "visual quality" for tourists. Thus timbering was not the major focus of forestry management and it showed in the analysis. Harvested timber (300 Em\$/ha) was an order of magnitude less than the other activities.

However, timber, once harvested, continues to attract energy investment. It serves as raw material for the forest products industry, and eventually becomes a consumer product. For example, if the wood were to be made into plywood, the 300 Em\$ value would attract another 200 Em\$, based on the multipliers developed from the energy evaluation of the U.S. forest products industry. Applying North Carolina's average energy investment ratio to the timber harvested from Wine Spring Creek indicated that the wood could attract outside resources at the rate of 3.8 to 1. Thus, 1140 Em\$ could be added on top of the timber's environmental value of 300 Em\$ for a total value of 1440 Em\$. This places timber's economic benefit in line with the value of the other ecosystem goods and services, slightly below its recreational value. This indicated that multiple-use function of the Wine Spring Creek watershed was satisfied, and that

total empower was maximized over the long-term since all activities were equally represented.

Value of biogeochemical cycles

Maintenance of nutrient cycles is an important ecological service that was evaluated for the forested watersheds of the Southern Appalachian Mountains. According to the emergy evaluation of Coweeta watershed, nutrients were being cycled at the rate of 360 kg/ha/y (see Table 3-1). The empower required to operate all of the individual biogeochemical cycles (i.e., calcium, sodium, ammonium, magnesium, potassium, sulfate, nitrate, chlorine, bicarbonate, phosphate, and silicon dioxide) of the watershed was 5.6 Em\$ per kilogram of total constituent (6.2 E9 sej/g; see Table 3-1).

Calcium was selected as an important element to evaluate with emergy. The emergy evaluation of the calcium cycle revealed that ratio of environmental empower to mass flow (emergy per mass) was 25 Em\$/kg-Ca (27 E9 sej/g-Ca), which was higher than the average determined for the total mineral cycle. The reason being that the calcium cycle was assumed to be a co-product (co-cycler) of the internal mineral cycle. Any mineral recycled within the forest must be necessary for the system to operate or it would not be re-used. Therefore, any process that is critical to the functioning of the total system required all of the system's inputs in order to work properly. With this accounting philosophy, the total empower driving any one elemental cycle was the same as the empower driving the whole watershed. For the Coweeta watershed, this meant that the empower of the calcium cycle was 2030 Em\$/ha/y (2237 E12 sej/ha/y; see Table 3-1).

The question arose of how to allocate empower to the watershed's exported calcium. In this study, the calcium exported was considered a split of the internal

calcium cycle. Therefore it had the same emergy per mass as the internally cycled calcium (27 E9 sej/g). This meant that the exported calcium had the same quality as the internally cycled calcium. The value of the dissolved calcium in the stream water was determined to be $170 \text{ Em\$/ha/y}$.

Value of recreation in Wine Spring Creek watershed

The Em\$ value of recreation and tourism within the Wine Spring Creek watershed was determined to be $1880 \text{ Em\$/ha/y}$ ($2.1 \text{ E6 Em\$/y}$). Of this total value, the environment contributed 55% and 45% was imported. Thus, the environmental loading ratio of eco-tourism was 0.83 (935 E12 to $1130 \text{ E12 sej/ha/y}$). An environmental loading ratio (ELR) of one (1) may be the match that optimizes environmental use. A value much lower, may indicate that the environment was under utilized, and resembled wilderness. On the other hand, an ELR much greater than one was probably "unhealthy" for the ecology of the watershed.

Value of research at Coweeta

A complete emergy analysis of the long-term research (60+ years) at Coweeta was not conducted, but an approximation of the total value of the research was made based on the emergy analysis of research publication record for the Wine Spring Creek Ecosystem Demonstration Project. If the 880 publications associated with the Coweeta Hydrologic Lab (Stickney et al., 1994) had the same emergy-to-publication ratio ($450 \text{ E15 sej/publication}$) as those of the Wine Spring Creek, then the total value was 396 E18 sej (360 million Em\$). Most likely, this was a conservative estimate, since the intensity of investigation at Coweeta has been much greater, historically, than that of the Wine Spring Creek.

Value of tree species in Wine Spring Creek watershed

Tree species were estimated by the EMSPECIES model to be worth about $2.6 \text{ E}24$ sej ($2.2 \text{ E}12$ Em\$) for the entire 1128 ha Wine Spring Creek watershed. The six (6) meters of saprolite, which required about $5 \text{ E}5$ years to form, was worth $7.3 \text{ E}20$ sej/ha ($700 \text{ E}9$ Em\$). The 350 MT/ha of total organic matter was valued at $8.0 \text{ E}17$ sej/ha ($765 \text{ E}6$ Em\$) and the 135 MT/ha of wood was worth $1.7 \text{ E}17$ sej/ha ($163 \text{ E}6$ Em\$).

Comparisons of the Ecological Economics of Forest Systems

Emergy Measures of Living Standard

The total emergy use per area was 1.38×10^{12} sej m^{-2}/y in N.C. (Table 3-21), 0.38×10^{12} sej m^{-2}/y , in Macon county (Table 3-20), and 0.46×10^{12} sej m^{-2}/y in Wine Spring Creek basin (Table 3-19). Thus, the multiple-use activities of the Wine Spring Creek watershed were occurring at an intensity less than the average for North Carolina, but greater than Macon County's.

Annual per capita empower, a measure of living standard, was $2.73 \text{ E}16$ sej/person/y ($23,000$ Em\$/person/y) in N.C, and slightly less in Macon county at $2.16 \text{ E}16$ sej/person/y ($18,000$ Em\$/person/y). Wine Spring Creek had no permanent residents, but a comparable measure was the annual empower per tourist-year ($20.4 \text{ E}16$ sej/person/y; $174,000$ Em\$/person/y). The high value experienced by the tourists showed how rewarding the nature experience was. Even the renewable fraction of the empower per capita in the Wine Spring Creek watershed was $4.34 \text{ E}16$ sej/person/y ($34,000$ Em\$/person/y). This may explain why people are drawn to the unpopulated forested mountains; they experience a high rate of free empower.

If per capita empower consumption is an appropriate measure of living standard, then North Carolinians have had the same standard of living since 1973. The growth in per capita empower consumption stopped increasing in 1973 and remained near 24 E15 sej/person/y to 1994 (Figure 4-2). In contrast, the per capita gross state product increased at an average annual rate of 2.9% from 1977 to 1994 (Figure 4-2). The combination of these two phenomena led to a temporal pattern of exponential decay in North Carolina's energy-to-dollar ratio over the period from 1977 to 1994 (Figure 4-3). In 1977, the energy-to-dollar ratio of N.C. was 4 E12 sej/\$, but had declined to 1 E12 sej/\$ by 1994. This pattern was similar to that of the U.S. economy as calculated by Odum (1996).

Some interpretations of this phenomenon are i) N.C.'s economy has increased its efficiency of empower use, acquiring more product for the same energy use, ii) the divergence of energy use and GSP represents inflation, more dollars are needed for the same resources, iii) the economy has become more urbanized, forcing more market exchanges to take place for the same amount energy use, or iv) a mix of all three.

Energy Measures of Sustainability

One gauge of system sustainability is its ability to support itself for an extended period of time. Long term sustainability means to rely solely upon indigenous, renewable energy sources. Thus, the simplest measure of system sustainability may be the fraction of total empower derived from indigenous, renewable sources.

For N.C. the fraction was 0.10 (Table 3-21), for Macon County it was 0.22 (Table 3-20) and for the Wine Spring Creek watershed it was 0.27 (Table 3-19). None of the forested systems were sustainable by this definition.

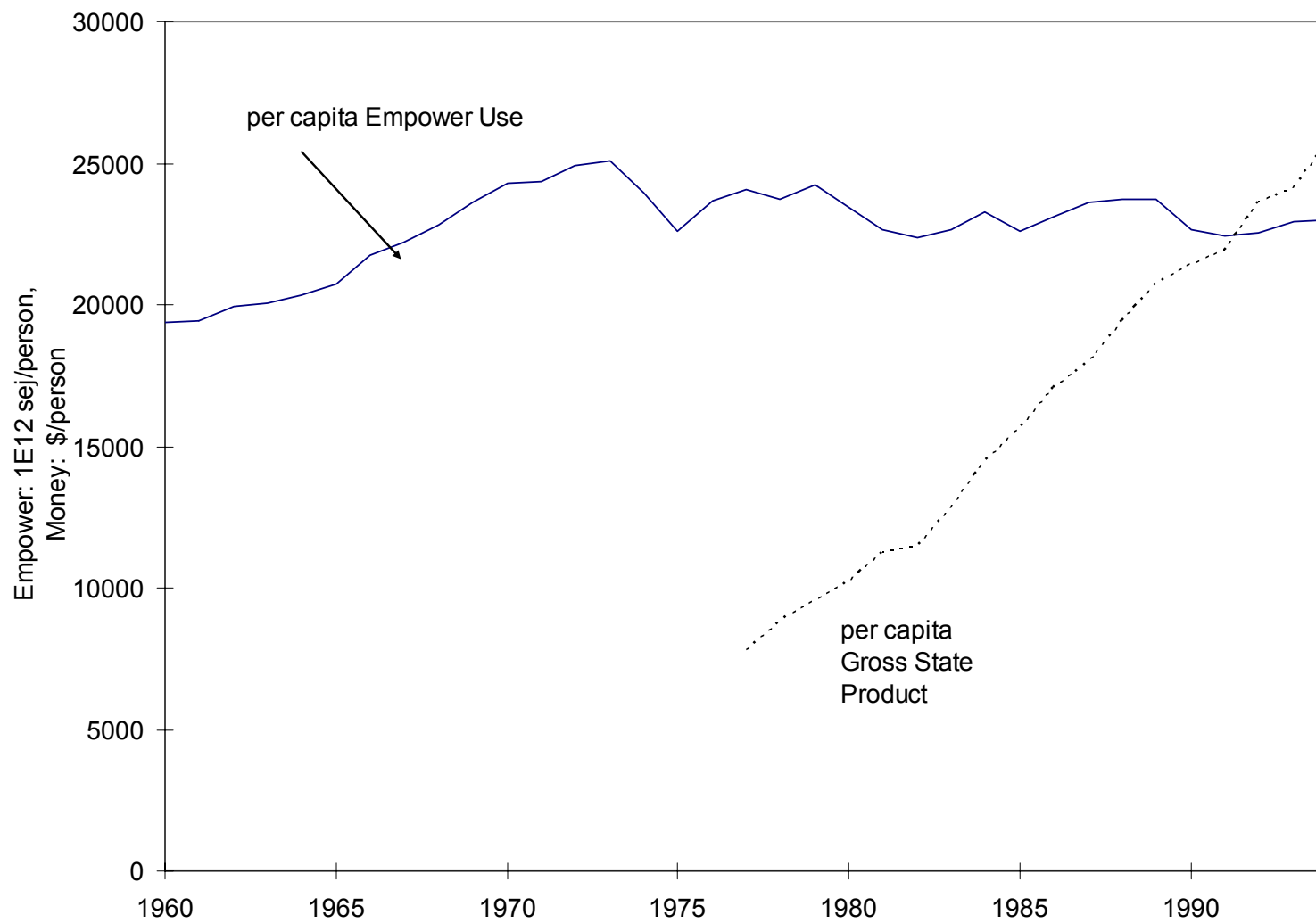

Figure 4-2. North Carolina's per capita empower consumption and per capita gross state product.

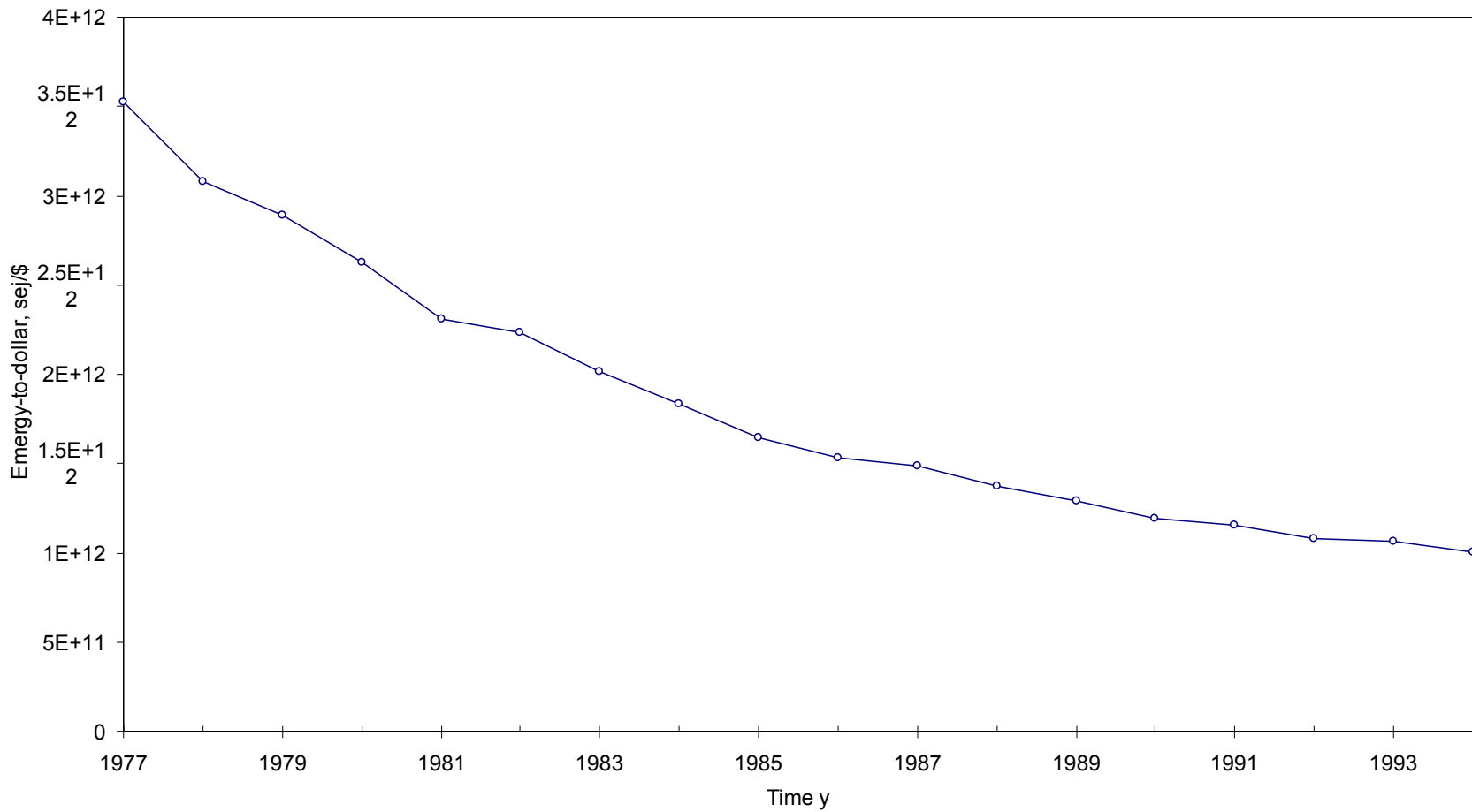

Figure 4-3. Energy-to-dollar ratio of North Carolina from 1977 to 1994. Total empower used in N.C. per unit of gross state product.

Using only renewable resources, North Carolina could sustain a population of 772,000--one-ninth of its current population of seven (7) million--at the present standard of living (Table 3-21). Conversely, the present population could be sustained with the renewable base if the standard of living was reduced to one-ninth (2.7 E15 sej/person/y; 2500 Em\$/person/y).

In Macon County, a population of 5100 could be sustained at the current standard of living if only renewable resources were used (Table 3-20). Or, the present standard of living could be reduced to 4.7 E15 sej/person/y (4300 Em\$/person/y) to fit with the availability of renewable resources and sustain the present population.

Two other indices that related environmental empower to imported empower were also used to gauge sustainability. The first, the ratio of total imported empower to locally free empower (renewable + non-renewable) indicated each systems' reliance on outside sources. The second, the ratio of concentrated empower (imported + indigenous non-renewable) to locally renewable empower indicated the intensity with which the environment was being used. The latter was termed the environmental loading ratio (ELR). Table 4-2 compares the value of the indices for North Carolina, Macon County, and Wine Spring Creek watershed.

Table 4-2. Emergy investment ratios of forested systems

System	Concentrated to Free ^a	Environmental Loading Ratio ^b
North Carolina	3.8	9.1
Macon Co.	1.6	3.6
Wine Spring Creek watershed	2.7	2.7

^aConcentrated to Free = $(F+G+P2I+N1)/(R+N0)$; see Figures 3-19 and 3-28.

^bEnvironmental Loading Ratio = $((N0+N1+F+G+P2I)/R)$; see Figures 3-19 and 3-28.

North Carolina was importing 3.8 solar emjoules for every free solar emjoule (column 2 of Table 4-2), while Macon County was importing less, 1.6 per one free. In the Wine Spring Creek watershed the environmental empower was matched with imported empower at 2.7:1, a rate less than the state's average of 3.8, but more than the county's 1.6.

The environmental loading ratio showed that economic emergy use in N.C. was 9.1 times greater than environmental empower (Table 4-2). In Macon County the environmental empower was matched with empower from non-indigenous, non-renewable resources at 3.6:1, while in the Wine Spring Creek basin the ratio was 2.7:1. Over the long-term, none of these systems were sustainable at this level of use. For their current levels of use, each required the importation of outside resources. Once external resources become scarce, these systems likely will falter to keep up with their present levels of activity.

Spatial configuration of sustainability in North Carolina

Since the environmental loading ratio (ELR), purchased to renewable, was an index of sustainability, it was calculated for all 100 counties of North Carolina to gain some perspective on the spatial configuration of sustainability. Thirty-four (34) of the one-hundred (100) counties had ELR's greater than the state average of 9.1, while sixty-six (66) counties were below the average. The majority of the unsustainable counties were located in the Piedmont region, centered about U.S. Interstate 85 from Charlotte to Greensboro to Raleigh (see Figure 3-36). The majority of the counties of the mountain region and coastal plain had ELR's less than the state average of 9:1.

Sustainability of forestry

The mean environmental loading ratio (ELR) of forest logging in the U.S. was 0.17. Relative to other agricultural activities this ratio was quite low. Pine plantations of New Zealand (Odum and Odum 1983), Texas cotton (Odum and Odum 1987), North Carolina tobacco (this study, see Appendix G) had ELR's of 1.4, 9.6, and 20.0, respectively. This meant that forestry impacted the environment less and was more sustainable than these other forms of agriculture.

Sustainability of tourism and human immigration in Macon County

Western N.C. has been a popular tourist attraction for many decades. Controversial though, are the benefits of large-scale tourism. Tourists can impact their destination by acquiring much more of the local energy budget than they give back to the local economy. The cumulative impact of tourism in Macon County equaled $2.74 \text{ E20 sej y}^{-1}$, but only one-fifth (0.49 E20 sej/y) of this input benefited the local economy in form of money payments (Table 3-7). The tourist gained four (4) units of emergy for every one (1) unit they spent. Of course, this may be an inevitable property of a tourist driven economy; people will only recreate where the emergy benefit greatly exceeds their emergy forfeiture.

The coupled aging of the U.S. population and their growing personal financial wealth has increased the demand for both retirement and vacation homes. Macon County, surrounded by National Forest lands and only a couple of hours drive from large metropolitan areas such as Atlanta and Charlotte, has been a favorite locality for people to retire and to purchase second homes. In 1992, the net migration to the county was 503 people, 2% of the population. One measure of the impact of this phenomenon is the

additional flow of energy the people will demand from the County's total resources.

Table 3-7 showed that county immigrants increased the flow of energy in Macon county by 0.47 E20 sej/y (9% of annual total use). Thus, adding residents caused energy use to increase faster than population growth.

The Dynamics of Energy, Empower and Transformity

Calculating Transformities Dynamically

A simple, one state variable model (EMERGYDYN) was used to calculate the transformity of processes and storages, dynamically through time. The technique, modified from Odum's (1996) initial suggestions, was based on the premise that a unit accumulated energy up to the point when energy outflow equals energy inflow. In the simulations conducted in this work, the condition that there was some export of energy had to be satisfied in order not to invoke an automatic cut-off for the energy accumulation process.

The temporal simulations of energy accumulation by wood biomass, total organic matter, and saprolite, showed that energy and transformity lagged the state variable, reaching their respective steady state values much later. In forest ecosystem management, 'old-growth' forest could be defined according to a minimum energy accumulation. The simulations conducted here (Figure 3-8 and 3-10) showed that the Coweeta forest required ~300 years for the transformity of its wood to reach steady state, although the wood biomass had climaxed by the one-hundredth year.

In future energy evaluations, it will be important to use this dynamic calculator when the window of interest covers the whole growth cycle, from birth to maturity. If an analyst was only interested in the energetics of a unit of a short period of its life-cycle,

then temporally dynamic calculation may not be necessary. In this work, the focus was on forests management which spanned 100 years or more. The length of that time scale allowed for significant accumulation of emergy. Thus, it was important to distinguish between young and old stands of forests by their transformity and emergy values.

Accounting for the Energy Transformation Processes of the Landscape

Environmental energies impinge on the watershed landscape perpendicular to the surface. The drainage basin, formed with past hydrogeologic work, captures the empower of the diffuse environmental energies (uplift, rain, vapor deficit) in the uplands and accumulates the empower as the water is converged downstream through the stream network. Thus, the stream flow leaving a watershed accumulated the empower of the whole basin. The drainage network is organized as a continuous chain of energy transformations, and has properties similar to any chain of energy transformations.

In the work presented here, a simple method for calculating this convergence of empower across the landscape was demonstrated for the Wine Spring Creek watershed. The method follows the framework given by Romitelli (1997) and Diamond (1984), but extends the concept to include the land's geologic contribution, and applies the techniques in a grid (raster) based geographic information framework. Since properly defining the spatial configuration of the empower of the watershed is critical to understanding the energy transformation processes of the landscape, and since the methodology is quite simple to apply, it should be incorporated in future emergy evaluations of watersheds.

Dynamics of Emergy-to-money Ratio and Transformity in the Forest Products Industry

For the wood products industry, the emergy-to-\$ ratio correlated with the inverse of the logarithm of the transformity of the product (see Figure 3-32). The simplified units

of the slope were energy per dollar. An intriguing idea is what the slope of the graph would be for other natural materials such as petroleum, metals, water or agricultural products. Possibly, the slope would be identical for all materials, but just as likely, it would indicate some inherent difference in the materials themselves or the system of which they were a part (e.g., the economy). In any case, the energy quality of a material explained the variability in the energy-to-dollar ratio.

Shown in Figure 4-4 is a temporal empower difference spectra, a new category of empower spectra that plots the difference between two empower spectra representing the same process, but calculated for different time periods. It was constructed to note the change in individual inputs to the U.S. pulpwood industrial sector between 1972 and 1990. For each energy input (e.g., biomass, electricity, labor, etc.), the difference between empower input per power output for 1972 and 1990 were calculated and plotted as a function of their solar transformity. Empower use per unit of pulp output decreased for all major energy sources except electricity, which increased by 500 sej per J of pulp output. The biggest decrease was in petroleum, which was down 5000 sej per J of pulp output. (Note: the transformity of the inputs was held constant to evaluate the change in empower. The consequences of this simplifying assumption should be explored in the future).

The data in Figure 4-4 was derived from Tables G-1 and 3-14. In 1972, the industry produced pulp that had a mean transformity of $6.9 \text{ E}4 \text{ sej/J}$ (Table G-1). By 1990, the transformity dropped 13% to $6.0 \text{ E}4 \text{ sej/J}$ (Table 3-14). Conversely, the energy-to-dollar ratio decreased from $47.3 \text{ E}12$ to $9.3 \text{ E}12 \text{ sej/J}$ over the same period.

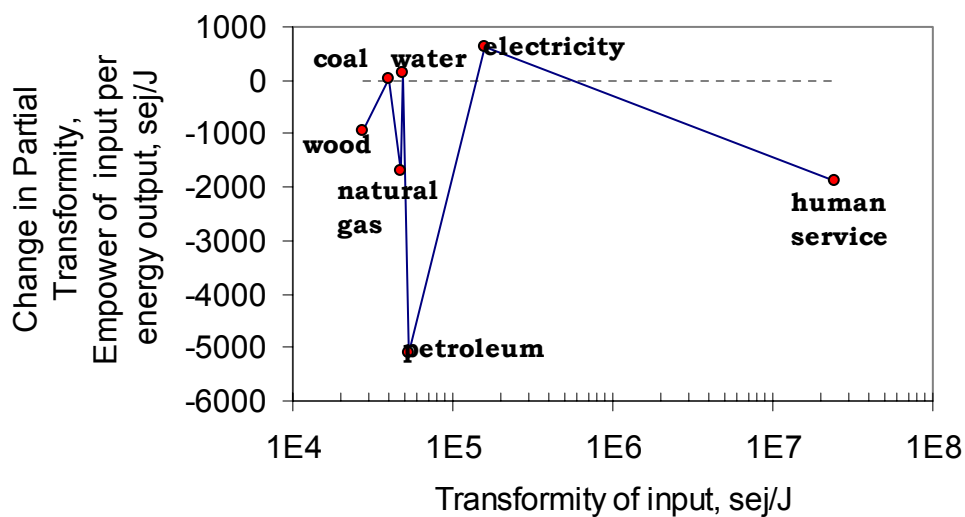

Figure 4-4. An empower difference spectra of the U.S. woodpulp production industry (1972 vs. 1990). Transformity of woodpulp in 1972 was $6.9E4$ sej/J, but decreased 13% to $6.0E4$ sej/J by 1990. The graph shows the differences between the empower inputs, normalized to a unit of output (sej/J), plotted as a function of transformity of the input (sej/J). Values above zero indicate that more of that input was used in 1990 than in 1972.

Thus, the change in solar transformity of a manufactured product (woodpulp) was modest over a period of 18 years. The decrease in solar transformity, averaged over the 18 year period was 0.7% per a year. On the other hand, the emergy-to-dollar ratio of a manufactured product decreased significantly, by a factor of five (5), over the 18 year period. This change represents inflation. A dollar spent in 1990 only purchased 20% of the wood pulp that a 1972 dollar did.

An Explanation for the Fluctuating Empower Spectra of North Carolina

The spectra of empower use in North Carolina (Figure 3-26b) exhibited a fluctuating pattern in the domain of solar transformity between $1 \text{ E}4$ and $1 \text{ E}5 \text{ sej/J}$. Figure 4-5 offers a possible explanation for the phenomenon. First, assume that two energy transformation processes (1 and 2 in Figure 4-5a) in series were a function of three energy sources (L, M, N in Figure 4-5a), where L, M, and N had increasing solar transformities (a popular configuration according to emergy systems theory). Next, consider that total production (P2) remains the same, but that N increases (a shift along the isoquant for process 2 in Figure 4-5b). Assuming that over a small interval, N and P1 are substitutable inputs to process 2, then P1 must be decreased to accommodate the change. A drop in P1 results in lower demand for M if L remains the same (a move to the lower isoquant for process 1 in Figure 4-5b). The end result is a fluctuation in the empower spectra for the combination of process 1 and 2 (Figure 4-5c).

Transformity of yield versus transformity of contributing resource storage

The ratio of the transformity of the extracted timber to the time-averaged transformity of the wood of the contributing forest was calculated for the Coweeta forest under various logging rotations. In Figure 4-6, the ratio is shown to decrease

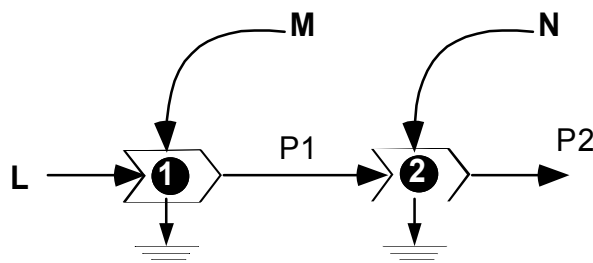

a) diagram of energy chain necessary for producing P2

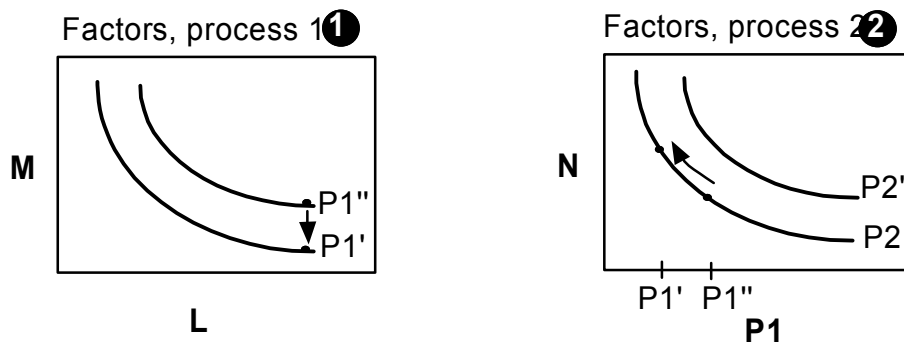

b) production isoquants for process 1 and process 2

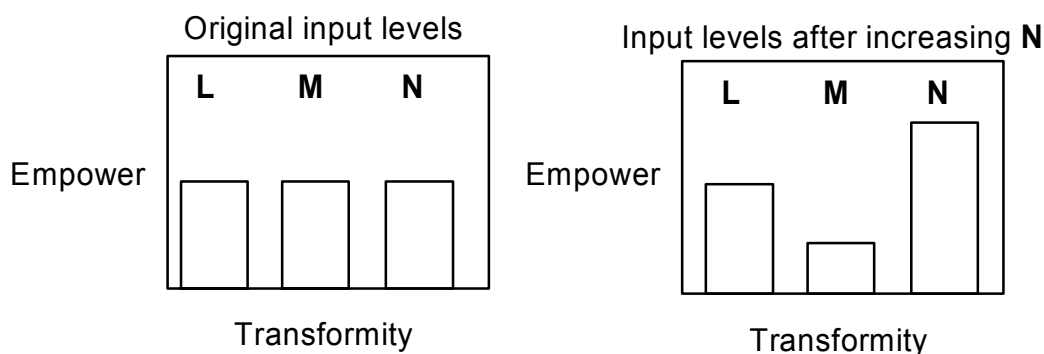

c) empower spectra for diagram in (a) before and after changes in M and N

Figure 4-5. A possible explanation for the dynamics observed in the empower spectra of the forest systems evaluated. A simple system of three inputs (L,M,N) and two interactions (1&2) produce a final product P2 (a). Production isoquants demonstrate the substitutability of M for L, and N for P1 (b). In (c), changes in the empower spectra are shown. Originally, the empower of inputs L,M&N were equivalent when producing P2. Later, N was increased but P2 was held constant. This decreased the need for P1 in process 2 which, in this case, decreased the need for M assuming that L did not change.

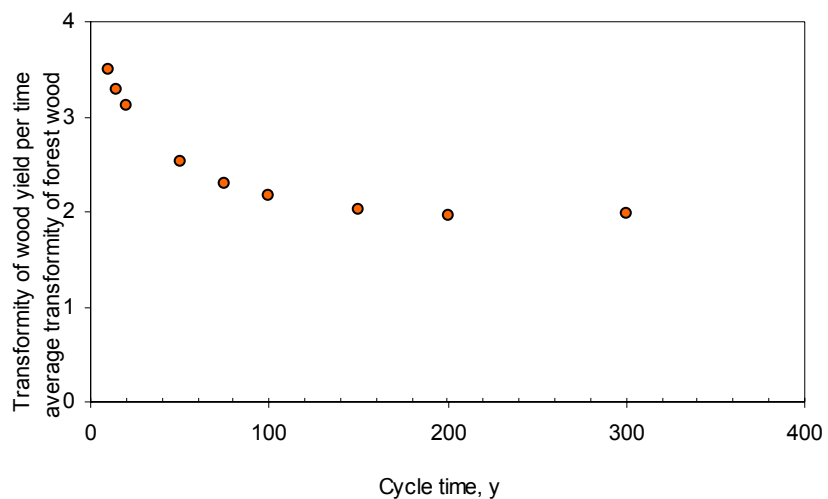

Fig. 4-6. Ratio of the mean transformity of forest yield (Y in Figure 3-42a) divided by average transformity of forest wood (Q in Figure 3-42a) calculated from the EMERGYDYN simulation model. At cutting frequencies > 100 y, the quality of the wood yielded to the economy was double that of the forest, averaged over the growing period. The quality of the yield for rotations < 20 y was from 3 to 3.5 times greater than the quality of the growing forest.

asymptotically to two (2) as the interval between cuttings increased. This means that when logging rotations were greater than 100 years the quality of the timber (yield) was twice as great as the quality of the forest. For shorter cycle times, the ratio was greater than two (2) indicating that the receiver of the timber was getting a much higher quality product than was left behind in the forest.

Comparisons of mountains and urban landscapes based on empower density

Cities are places of high empower density, as are mountains. In a well-organized ecological-economic system, cities feedback high quality energy (e.g., legal, religious, etc.) and recycle waste materials (e.g., solid and liquid wastes) to the surrounding landscape. The feedback is necessary to maintain the foundation of the city's energy network. Development of urban systems as centers for controlling the activities of the landscape seems analogous to the development of mountains as agents that control landscape processes. The analogy can be extended quantitatively by comparing the empower density of the two different landscapes.

The empower density of mountain landscapes was found to increase with altitude (see Appendix D). The mean empower density of North Carolina and a mountain 2800 m (~9200 feet) above sea level were both $12.8 \text{ E}15 \text{ sej/ha/y}$. The county of Mecklenburg, home of the state's largest city, Charlotte, had a mean empower density of $134 \text{ E}15 \text{ sej/ha/y}$ coinciding with the empower density of a 5100 m (16,750 ft) mountain.

Humans living in high altitude environments are stressed by low oxygen pressure, a condition known as hypoxia. At sea level, blood hemoglobin is nearly 100% saturated to $19.5 \text{ mL-O}_2/100 \text{ mL-blood}$. At this concentration, 5 mL-O_2 can be transferred to tissue for each 100 mL of blood (a drop to $14.5 \text{ mL-O}_2/100 \text{ mL blood}$). The atmosphere's

partial pressure of oxygen decreases with altitude. At 6000 m oxygen pressure is ~40mm Hg, which corresponds to the 14.5 mL-O₂/100 mL-blood where oxygen transfer to tissue is minimal. Interestingly, the empower density of mountains at an altitude of 6000m is 343 E15 sej/ha/y, which is over two and a half times (2.6) the empower density of Charlotte. Pawson and Jest (1978) as reported in Stone (1992) suggest that an elevation of 2500m is the delimiter of hypoxia. The empower density of mountains at 2500 m was 8.9 E15 sej/ha/y, which in North Carolina was the empower density at which the emergy investment ratio of several counties was 7:1 (purchased:renewable).

Does the empower density of natural landscapes offer clues as to how much urbanization is locally sustainable? In the future it would be interesting to pursue this line of evidence more thoroughly. Some questions to investigate would be: where is the highest empower density on earth? Is it a man-made or natural feature? If it is man-made, how does its empower density compare to Mt. Everest or the mouth of the Amazon River? Does the empower density of mountains which corresponds to the ecological limit of trees (the tree line) or other life forms correspond to the empower density of the largest cities?

Plans for Future Research

Emergy evaluation is a powerful tool for analyzing and quantifying the importance of the multiple forcing factors, internal pathways and units, and outputs of forested systems. In this dissertation, the utility of the emergy spectra as both a visual and analytical tool for studying the interrelationships between the multiple forms of energy was emphasized. To fully realize the strength of this analytical tool, spectra need to be developed for all the world's biomes and compared to one another. Only then will

the emergy spectra's ability to integrate and synthesize our understanding of ecosystems be appreciated.

The ramifications of calculating transformities and emergy accumulation dynamically need to be investigated further. This is especially important when the time scale of interest is as long or longer than the time required for the transformity of a process to reach its steady state.

The methodology for calculating the empower and transformity of mountains, which was introduced here, needs to be more thoroughly investigated. The emergy contributed by land resources (e.g., minerals, uplift) to ecological and economic systems needs to be accounted for more thoroughly.

Emergy valuations of biogeochemical cycles, begun here with the calcium cycle, need to be undertaken and explored.

Work that strives for systems evaluations of forest management needs to continue. Emergy evaluation shows promise in comparing the multiple functions of forest systems and can lend valuable insight into the consequences of meeting the public's increasingly diverse set of goals. Therefore, emergy evaluation should play a central role in evaluating forest policy for its total, long-term benefit to society.

GLOSSARY
TERMS AND DEFINITIONS

Available Energy	Potential energy capable of doing work and being degraded in the process (units: kilocalories, joules, etc.)
Useful Energy	Available energy used to increase system production and efficiency
Power	Useful energy flow per unit time
Emergy	Available energy of one form previously required directly and indirectly to make a product or service (units: emjoules, emkilocalories, etc.)
Transformity	Emergy per unit available energy (units: emjoule per joule)
Empower	Emergy flow per unit time (units: emjoules per unit time)
Solar Emergy	Solar energy required directly and indirectly to make a product or service (units: solar emjoules, sej)
Solar Transformity	Solar emergy per unit available energy (units: solar emjoules per joule, sej/J)
Solar Empower	Solar emergy flow per unit time (units: solar emjoules per unit time)
Emdollars (Em\$)	The commensurate amount of dollar circulation resulting from the use of emergy
Earth deep heat	Heat emanating from deep within earth from radiogenic and residual sources

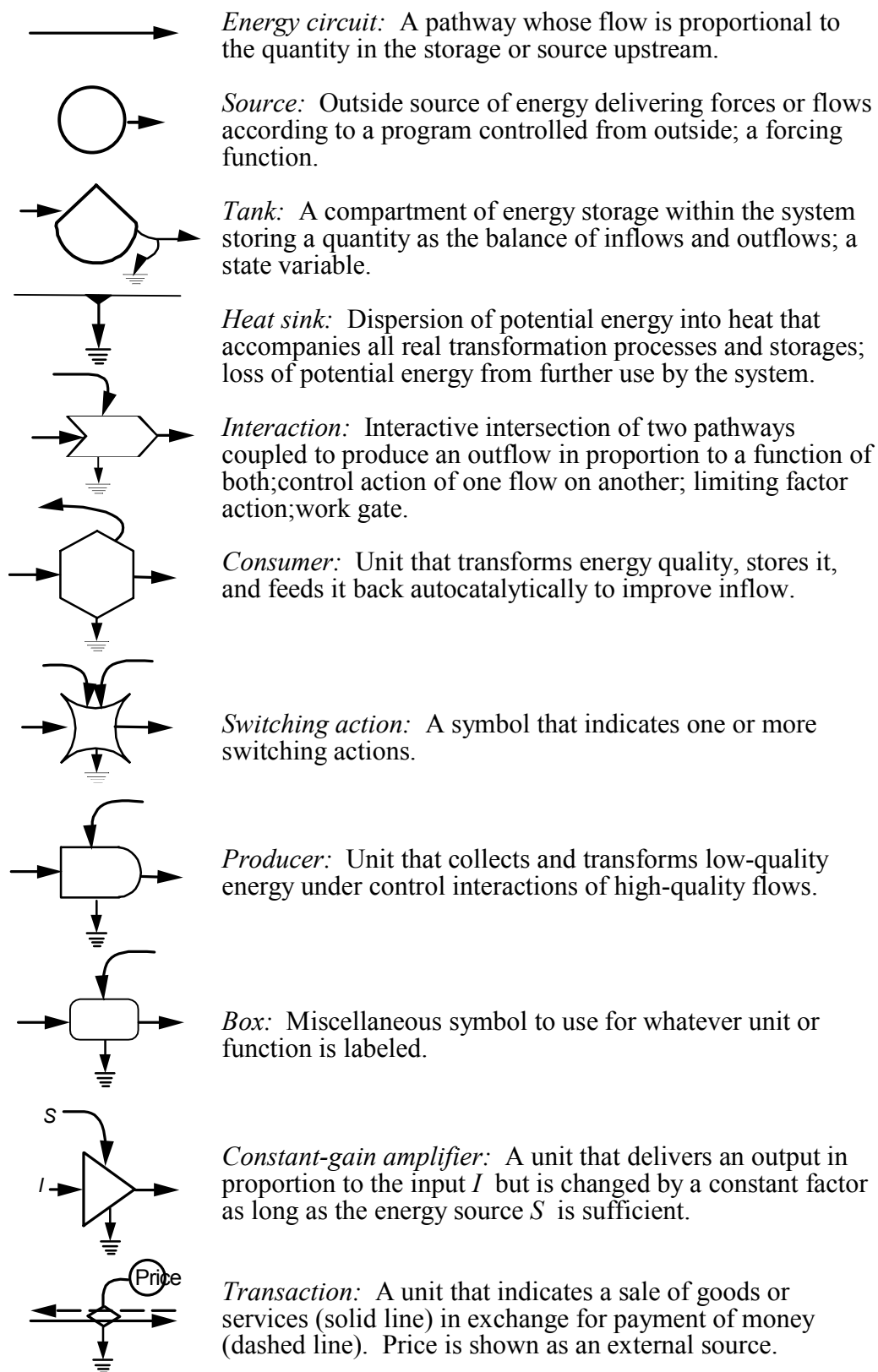

Figure Glossary-1. Energy systems symbols and definitions.

APPENDIX A
SOLAR TRANSFORMITIES USED FROM PREVIOUS WORK
AND FOOTNOTES TO EMERGY EVALUATION TABLES

Appendix A contains a list of the solar transformities, previously calculated by others, which were used in this work (Table A-1). This appendix also has the footnotes for the majority of the emergy evaluation tables. A few tables with short footnotes (Table 3-6, 3-12) are listed at the bottom of the tables themselves. Here, footnotes are given for the watershed analyses (Table 3-1, 3-2, 3-4, 3-5), Macon county (Table 3-7), North Carolina (Table 3-9, 3-11), and the U.S. forest products industry (Table 3-13, 3-14, 3-15, 3-16, 3-17, 3-18).

Table A-1. Summary of solar transformities previously calculated and used in this dissertation

Item	Energy Transformity, per mass,		Source
	sej/J	sej/g	
Environmental Energies			
Sun	1.0E+00		Odum, 1996
Wind, kinetic (global average)	1.5E+03		"
Precipitation, geopotential (global average)	1.0E+04		"
Tide (global average)	1.7E+04		"
Hurricanes, wind	1.0E+04		?
Precipitation, chemical potential (global average)	1.8E+04		Odum, 1996
Waves (global average)	3.1E+04		"
Earth deep heat (global average)	3.4E+04		"
Human metabolism (United States)			
Visitors to Wine Spring Creek	8.9E+06		"
Immigrants to Macon	2.4E+07		"
Scientists	3.4E+08		"
Erosion (global average)		1.0E+09	"
Fuels, electricity, & minerals			
Petroleum	6.6E+04		?
Coal	4.0E+04		Odum, 1996
Natural gas	4.8E+04		"
Electricity	1.6E+05		"
Hydroelectricity	1.6E+05		"
Non-fuel minerals (e.g., granite, sand&gravel)		5.0E+08	"
Machinery, heavy		6.9E+09	?
Phosphate rock, mined (Florida)		3.9E+09	Odum, 1996
Metals		1.0E+09	?
Agricultural products			
Livestock (Texas cattle)	2.0E+06		Odum & Odum, 1987.
Crops (Texas grains)	2.0E+05		"
Fish	2.0E+06		assumed same as livestock

Footnotes to Table 3-1 (emergy evaluation of Coweeta watershed)

1 **SOLAR ENERGY**

$$\begin{aligned}
 \text{Land Area of 1.0 ha} &= 10,000 \text{ m}^2 \\
 \text{Insolation @ ground} &= 5.00\text{E}+9 \text{ J/m}^2/\text{yr} \text{ (Swift et al., 1988)} \\
 \text{Energy(J)} &= (\text{area}) \times (\text{avg insolation}) \\
 &= (\text{ } \text{m}^2) \times (\text{ } \text{J/m}^2/\text{y}) \\
 &= 50.0\text{E}+12
 \end{aligned}$$

2 **Vapor saturation deficit**

	Mean conditions	Effects of ET	Difference
Atmos. pressure, mb	1000	1,000	
Mean annual temp. C	12.6	12.6	
sat. vap. press.(e _s), mb	14.60	14.60	
sat. mix. ratio (q _s), g/kg	9.08	9.08	
Evapotranspiration (ET), g/y		9.10E+09	
Air exchange, m ³ /y		3.75E+11	
Depression of mix. ratio, g/kg		0.0202	
vapor press.(e), mb	12.20	12.24	0.0325
mix. ratio (q), g/kg	7.59	7.61	0.0202
sat. deficit (q _s -q), g/kg	1.49	1.47	-0.0202
sat. deficit (e _s -e), mb	2.39	2.36	-0.03
free energy, J/kg	198.3	195.6	-2.69
free energy, J/m ³	238.0	234.8	-3.23

Mean annual temperature at climate station CS01 in Coweeta basin.

Saturation vapor pressure (e_s), mb = 611*EXP((17.27*T)/(237.3+T))/100

Where T is mean annual temperature, C

Saturation mixing ratio, g/kg = 622x(e_s,mb)/(air pressure,mb)

Evapotranspiration, g/y = (0.91 m/y)x(10,000m²/ha)x(1E6 g/m³)

Air exchange, see Table cow-wind

Depression of mix. ratio, g/kg = (ET, g/y)/(Air exchange, m³/y)/(1.2 kg/m³)

mix. ratio, g/kg is mean annual for CS01

Vapor pressure, mb = (mixing ratio, g/kg)x(air pressure,mb)/622

sat. deficit, g/kg = sat. mix. ratio - mix. ratio

sat. deficit, mb = sat. vapor pressure - vapor pressure

free energy, J/kg = -8.33*(273+T)*LN(((1000-q_s)/(1000-q))/18*100

Free energy of air mass = (8.33 J/mole/deg C)x(1 deg C)x (Loge((1000-sat. mix. ratio,g/kg)/(1000-mix.

Energy of the saturation deficit used, J/y = (difference in free energy, J/m³)x(air exchange, m³/y)

Energy of the saturation deficit used, J/y = (3.23 J/m³)x(375 E9 m³/y)

Energy of the saturation deficit used, J/y = 1.21E+12

3 **Wind, kinetic energy**

$$\text{Energy, J/y} = 1.88\text{E}+11 \text{ see Table D-1}$$

4 Water transpired

Land area, m ² =	10,000	
Rain, m/y =	1.94	WS 18 @ Coweeta (Swift et al., 1988)
Transpiration rate, m/y	0.91	WS 18 @ Coweeta (Swift et al., 1988)

$$\begin{aligned} \text{Energy on forest land (J)} &= (\text{area})(\text{Et})(\text{Gibbs no.}) \\ &= (\text{ } \text{m}^2)(\text{ } \text{m})(1000 \text{ kg/m}^3)(4940 \text{ J/kg}) \\ &= 4.47\text{E}+10 \end{aligned}$$

5 PRECIPITATION CHEMICAL POTENTIAL

Land Area, m ² =	1.00E+04	WS 18 @ Coweeta (Swift et al., 1988)
Rainfall, m/y =	1.94	WS 18 @ Coweeta (Swift et al., 1988)

$$\begin{aligned} \text{Water chemical energy used (J)} &= (\text{area})(\text{rainfall})(\text{density of water})(\text{Gibbs no.}) \\ &= (\text{ } \text{m}^2)(\text{ } \text{m})(1000 \text{ kg/m}^3)(4940 \text{ J/kg}) \\ &= 9.58\text{E}+10 \end{aligned}$$

6 Deep heat

Land Area (m ²) =	1.00E+04	
Heat flow / Area =	1.36E+06	J/m ² /y, @ Bryson City, NC (Smith et al., 1981; in Pollack et al., 1991).
Energy (J/ha) =	1.36E+10	

Transformity, 34,400 sej/J was the mean calculated for the continents by Odum, 1996.

7 PRECIPITATION, GEOPOTENTIAL

$$\begin{aligned} \text{Mid-elevation of WS 18, m} &= \sim (\text{max} + \text{min})/2 = (993 + 726)/2 \\ \text{Mid-elevation of WS 18, m} &= \sim 860 \\ \text{Energy @ mean elev. (J)} &= (\text{area})(\text{runoff})(\text{mid-elev} - \text{min. elev})(\text{density})(\text{gravity}) \\ &= (\text{ } \text{m}^2)(\text{ } \text{mm/y})/(1000 \text{ mm/m})(\text{ } \text{m})(1000 \text{ kg m}^{-3})(9.8\text{m/s}^2) \end{aligned}$$

$$\text{Energy, geopotential (J/ha)} = 13.5\text{E}+9$$

8 Atmospheric deposition, total ions

Ion	Atmospheric Input, kg/ha/y
Ca ⁺	3.63
Na ⁺	3.17
NH ₄ ⁺	1.78
Mg ²⁺	0.76
K ⁺	1.76
SO ₄ ²⁻ S	9.69
NO ₃ ⁻	2.67
Cl ⁻	5.07
HCO ₃ ⁻	1.27
PO ₄ ³⁻ P	0.08
SiO ₂	0.55
Total	30

Source: Swank and Waide, 1988.

Empower per ion influx (sej/g) assumed equivalent to mean global land cycle.

Footnotes to Table 3-1 (emergy evaluation of Coweeta watershed)

- 9 **Ca as dryfall (wind)**
 Dryfall deposition, kg/ha/y = 0.91 Swank and Waide, 1988.
- 10 **Ca as wetfall (rain)**
- 10a **Marine Origin**
 Concentration of Ca in rain of marine origin, mg/l = 0.005 Swank and Waide, 1988.
 Marine contribution, kg/ha/y = $(\text{0.005 mg/l})(1.93 \text{ m/y})(1\text{E}4 \text{ m}^2/\text{ha})(1000\text{L}/\text{m}^3)(1\text{kg}/1\text{E}6\text{mg})$
 Marine contribution, kg/ha/y = 0.097
- Empower-to-flux of cyclic salts = global empower divided by total minerals transported from sea to land; $(9.44\text{E}24 \text{ sej/y})/(2.6\text{E}14 \text{ g-salts/y}) = 36\text{E}9 \text{ sej/g-cyclic sea salt}$
- 10b **Terrestrial Origin**
 Concentration of Ca in rain of terrestrial origin, mg/l = 0.190 Swank and Waide, 1988.
 Terrestrial contribution, kg/ha/y = $(0.190 \text{ mg/l}) \times (1.93 \text{ m/y}) \times (1\text{E}4 \text{ m}^2/\text{ha}) \times (1000\text{L}/\text{m}^3) \times (1\text{kg}/1\text{E}6\text{mg})$
 Terrestrial contribution, kg/ha/y = 3.7
 Emery per gram is mean for global sedimentary-rock cycle
- 11 **Ca from rock weathering**
 Majority of rock weathered is calcium feldspar (molecular wt. 1064 of which 40 is Ca)
 Thus, Ca is 40/1064 of 482 kg/ha/y = 18
- 12 **Total Net Primary Prod. (NPP)**
 Annual NPP per ha = 14.6 MT Monk and Day, 1988.
 Energy(J) = $(\text{14.6 MT})(1\text{E}+06 \text{ g/MT})(3.5\text{kcal/g})(4186 \text{ J/g})$
 = 2.14E+11
- 13 **NPP aboveground**
 Annual NPP per ha = 8.4 MT Monk and Day, 1988.
 Energy(J) = $(\text{8.4 MT})(1\text{E}+06 \text{ g/MT})(3.5\text{kcal/g})(4186 \text{ J/g})$
 = 1.23E+11
- 14 **Root NPP**
 Annual NPP per ha = 6 MT Monk and Day, 1988.
 Energy(J) = $(\text{6 MT})(1\text{E}+06 \text{ g/MT})(3.5\text{kcal/g})(4186 \text{ J/g})$
 = 8.79E+10
- 15 **Wood Accumulation**
 Annual accum. per ha = 4.2 MT Monk and Day, 1988.
 Energy(J) = $(\text{4.2 MT})(1\text{E}+06 \text{ g/MT})(3.5\text{kcal/g})(4186 \text{ J/g})$
 = 6.15E+10
- 16 **Litter Fall**
 Annual litter per ha = 4.4 MT Monk and Day, 1988.
 Energy(J) = $(\text{4.4 MT})(1\text{E}+06 \text{ g/MT})(3.5\text{kcal/g})(4186 \text{ J/g})$
 = 6.45E+10

17 Leaf production

$$\begin{aligned} \text{Annual leaf prod per ha} &= 4.2 \text{ MT Monk and Day, 1988.} \\ &= (\text{--- MT})(1\text{E}+06 \text{ g/MT})(3.5\text{kcal/g})(4186 \text{ J/g}) \\ &= 6.15\text{E}+10 \end{aligned}$$

18 Rock weathering

$$\begin{aligned} \text{mean rate for all of Coweeta, cm/1000y} &= 3.8 \text{ Velbel, 1985.} \\ \text{Area, ha} &= 1 \\ \text{mean rate for WS 18, kg/ha/y} &= 482 \text{ Velbel, 1985.} \end{aligned}$$

$$\begin{aligned} \text{Mass of material} &= (\text{rate, cm/y}) \times (\text{area, ha}) \times (1\text{m}/100\text{cm}) \times (10,000\text{m}^2/\text{ha}) \times (1.5\text{g}/\text{cm}^3) \times (1\text{E}6\text{cm}^3/\text{m}^3) \\ \text{Mass of material, g/y} &= 570,000 \end{aligned}$$

Empower necessary for rock weathering is rain plus earth deep heat.

19 Calcium cycle

$$\text{Net annual uptake by vegetation, kg/ha/y} = 84 \text{ Monk and Day, 1989.}$$

$$\text{Emergy per mass, sej/g} = (\text{input empower: sum of rain + earth cycle as deep heat + dryfall Ca + wetfall Ca}) / (\text{internal Ca cycle})$$

$$\text{Emergy per mass, sej/g} = (84.2\text{E}12 \text{ sej/ha/y}) / (84000 \text{ g-Ca/ha/y})$$

20 Total mineral cycle

Element	Internal Uptake rate, kg/ha/y
Calcium	82
Potassium	88
Magnesium	21
Phosphorus	15
Nitrogen	156
Sulfur	?
Sodium	?
Total	362

Source: Monk and Day, 1988.

Empower of mineral cycle = (Empower input from rain + deep heat + atmospheric mineral deposition)

$$\text{Empower-to-flux of mineral cycle, sej/g} = (\text{--- sej/ha/y}) / (362 \text{ E}3 \text{ g/ha/y}) = 6.2 \text{ E}9 \text{ sej/g}$$

EXPORTS**21 Stream discharge**

$$\text{Runoff} = 1.035 \text{ m/y WS 18 @ Coweeta (Swift et al., 1988)}$$

$$\text{Chemical Energy(J)} = (\text{--- m}^2) \times (\text{--- m/y}) \times (1000 \text{ kg/m}^3) \times (4940 \text{ J/kg})$$

$$\text{Chemical Energy(J)} = 5.11\text{E}+10$$

$$\begin{aligned} \text{Geopotential Energy (J)} &= (\text{area})(\text{runoff})(\text{stream elev. above sea level})(\text{density})(\text{gravity}) \\ &= (\text{--- m}^2)(\text{--- m/y})(\text{--- m})(1000 \text{ kg m}^{-3})(9.8\text{m/s}^2) \end{aligned}$$

$$\text{Geopotential Energy (J)} = 6.37\text{E}+10 \text{ relative to sea level}$$

$$\text{Runoff (g)} = 1.04\text{E}+10$$

All calculated transformities (or empower-to-flux): [empower of rain + deep heat] / energy (or mass)

22 Calcium export

Footnotes to Table 3-1 (emergy evaluation of Coweeta watershed)

Ca export, kg/ha/y = 7 Swank and Waide, 1988.

Empower-to-flux ratio: assumed a split of internal cycle, therefore similar ratios.

Empower of Ca export = (Ca export, g/ha/y) x (emergy per mass of internally cycled calcium, sej/g-Ca)

23 **Total dissolved mineral export (based on WS 2)**

Ion	Output, kg/ha/y
Ca ⁺	5.45
Na ⁺	11.43
NH ₄ ⁺	0.02
Mg ²⁺	3.05
K ⁺	4.66
SO ₄ ²⁻ S	1.37
NO ₃ ⁻	0.02
Cl ⁻	6.18
HCO ₃ ⁻	40.4
PO ₄ ³⁻ P	0.02
SiO ₂	77.25
Total	150

Source: Swank and Waide, 1988.

Footnotes to Table 3-2 (emergy evaluation of Wine Spring Creek watershed)

1 SOLAR ENERGY:

Land area of WSC, ha = 1128 Forest Service
 Unit of analysis, m² = 10,000
 Insolation @ ground = 5.02E+09 J/m²/yr (taken from Coweeta, Swift et al., 1988)

$$\begin{aligned} \text{Energy(J)} &= (\text{area}) * (\text{avg insolation @ ground}) \\ &= (\text{m}^2) * (\text{J/m}^2/\text{y}) \\ &= 5.02\text{E}+13 \end{aligned}$$

2 VAPOR SATURATION DEFICIT

	Mean conditions	With evapo- transp.	Difference
Atmos. pressure, mb	1000	1,000	
Mean annual temp. C	12.6	12.6	
sat. vap. press.(e _s), mb	14.60	14.60	
sat. mix. ratio (q _s), g/kg	9.08	9.08	
Evapotranspiration (ET), g/y		5.38E+09	
Air exchange, m ³ /y		3.75E+11	
Depression of mix. ratio, g/kg		0.0120	
vapor press.(e), mb	12.20	12.22	0.0192
mix. ratio (q), g/kg	7.59	7.60	0.0120
sat. deficit (q _s -q), g/kg	1.49	1.48	-0.0120
sat. deficit (e _s -e), mb	2.39	2.37	-0.02
free energy, J/kg	198.3	196.7	-1.59
free energy, J/m ³	238.0	236.1	-1.91

Mean annual temperature at climate station CS301 in WSC basin.

Saturation vapor pressure (e_s), mb = 611*EXP((17.27*T)/(237.3+T))/100

Where T is mean annual temperature, C

Footnotes to Table 3-2 (emergy evaluation of Wine Spring Creek Watershed)

Saturation mixing ratio, g/kg = $622 \times (e_s, \text{mb}) / (\text{air pressure, mb})$

Evapotranspiration, g/y = $(0.91 \text{ m/y}) \times (10,000 \text{ m}^2/\text{ha}) \times (1 \text{E}6 \text{ g/m}^3)$

Air exchange, see Table cow-wind

Depression of mix. ratio, g/kg = $(\text{ET, g/y}) / (\text{Air exchange, m}^3/\text{y}) / (1.2 \text{ kg/m}^3)$

mix. ratio, g/kg: assumed mean annual for WSC

Vapor pressure, mb = $(\text{mixing ratio, g/kg}) \times (\text{air pressure, mb}) / 622$

sat. deficit, g/kg = sat. mix. ratio - mix. ratio

sat. deficit, mb = sat. vapor pressure - vapor pressure

free energy, J/kg = $-8.33 \times (273 + T) \times \text{LN}((1000 - q_s) / (1000 - q)) / 18 \times 100$

Free energy of air mass = $(8.33 \text{ J/mole/deg C}) \times (T \text{ deg C}) \times (\text{Loge}((1000 - \text{sat. mix. ratio, g/kg}) / (1000 - \text{mix. ratio, g/kg})) / (18 \text{ g/mole}) \times (1000 \text{ g/kg})$

Energy of the saturation deficit used, J/y = $(\text{difference in free energy, J/m}^3) \times (\text{air exchange, m}^3/\text{y})$

Energy of the saturation deficit used, J/y = $(1.91 \text{ J/m}^3) \times (423 \text{ E}12 \text{ m}^3/\text{y})$

Energy of the saturation deficit used, J/y = $7.17 \text{E}+11$

3 WIND ENERGY:

See Table D-2

Energy, Total (J) = $1.88 \text{E}+11 \text{ J/yr}$

Growing season only (April-September):

Energy, grow season (J) = $4.81 \text{E}+10 \text{ J/yr}$

Non-growing season (October-March)

Energy, winter (J) = $1.04 \text{E}+11 \text{ J/yr}$

4 PRECIPITATION, GEOPOTENTIAL ENERGY:

		<u>Hi-Wayah Bald</u>	<u>Lo-Nanta. Lake</u>	<u>Mean</u>	
Area	=			10000	m ²
Rainfall	=	1839	1697	1961	mm
Runoff	=			1423	mm
Elevation	=	1625	920	1318	m

Mean elev. determined from GIS topo-coverage

Footnotes to Table 3-2 (energy evaluation of Wine Spring Creek Watershed)

$$\begin{aligned} \text{Energy @ mean elev. (J)} &= (\text{area})(\text{runoff})(\text{mean elev.} - \text{min elev.})(\text{density})(\text{gravity}) \\ &= (\text{___ m}^2)(\text{___ mm/y})/(1000 \text{ mm/m})(\text{___ m})(1000 \text{ kg m}^{-3})(9.8 \text{ m/s}^2) \\ \text{Energy, geopotential (J)} &= 55.5\text{E}+9 \end{aligned}$$

5 HURRICANES

$$\begin{aligned} \text{Energy, J/event} &= 5.217\text{E}+11 \quad (\text{see Table ___ Hurricane estimate}) \\ \text{Energy, J/y} &= 5.217\text{E}+10 \end{aligned}$$

6 PRECIPITATION, CHEMICAL POTENTIAL ENERGY:

$$\begin{aligned} \text{Rain @ 925 m} &= 1,697 \text{ mm/y} \quad \text{Forest Service (long term)} \\ \text{Rain @ 1330 m} &= 1,961 \text{ mm/y} \quad \text{Forest Service (1995-1997)} \\ \text{Rain @ 1625 m} &= 1,839 \text{ mm/y} \quad \text{Forest Service (long term)} \\ \text{Mean E-T} &= 538 \text{ mm/y} \quad \text{Forest Service (1995-1997)} \\ \text{Total energy assuming rainfall @ 1330m (J)} &= (\text{area})(\text{rainfall})(\text{Gibbs no.}) \\ &= (\text{___ m}^2)(\text{___ mm})/(1000 \text{ mm/m})(1000 \text{ kg/m}^3)(4940 \text{ J/kg}) \\ &= 9.69\text{E}+10 \\ \text{Total energy (J)} &= 9.69\text{E}+10 \end{aligned}$$

7 EVAPOTRANSPIRATION,

$$\begin{aligned} \text{Mean E-T} &= 538 \text{ mm/y} \quad \text{CS301t (pers. comm. L. Swift, Coweeta)} \\ \text{Total energy assuming rainfall @ 1330m (J)} &= (\text{area})(\text{evapotranspiration})(\text{Gibbs no.}) \\ &= (\text{___ m}^2)(\text{___ mm})/(1000 \text{ mm/m})(1000 \text{ kg/m}^3)(4940 \text{ J/kg}) \\ \text{Total energy (J)} &= 2.66\text{E}+10 \end{aligned}$$

8 DEEP HEAT (1)

$$\begin{aligned} \text{Land Area (m}^2) &= 1.00\text{E}+04 \\ \text{Heat flow / Area} &= 1.36\text{E}+06 \quad \text{J/m}^2/\text{y, @ Bryson City, NC} \\ \text{Energy (J)} &= 1.36\text{E}+10 \quad (\text{Smith et al., 1981; in Pollack et al., 1991}). \\ \text{Transformity, 34,400 sej/J} &\text{ was the mean calculated for the continents by Odum, 1996.} \end{aligned}$$

If deep heat figured as a function of altitude.

Transformity, 75,000 sej/J based on height of geologic uplift (Appendix E)

9 ATMOSPHERIC DEPOSITION

Footnotes to Table 3-2 (energy evaluation of Wine Spring Creek Watershed)

Deposition rate, kg/ha/y = 30 30 estimate based on Coweeta (see Table cow-flow)

IMPORTED ENERGY SOURCES:

10 Gasoline of visitors

Gas within WSC = 3.70E+01 (bbl/yr) Table wsc3

Energy(J) = (____ bbl/yr)*(6.28e9 J/bbl)

Energy(J/ha) = 2.06E+08

11 Gasoline of thru traffic

Table wsc3

Gas within WSC = 3.70E+02 (bbl/yr)

Energy(J) = (____ bbl/yr)*(6.28e9 J/bbl)

Energy(J/ha) = 2.06E+09

12 Visitors, length of stay in WSC

Cordell et al., 1996.

no. of groups/yr = 4,361

mean group size = 2.7 people

mean length of stay = 19.0 hours

Energy(J) = (____ people-hrs/yr)*(104 Cal/hr)*(4186 J/Cal)

Energy(J/ha) = 8.63E+07

Transformity of 8,900,000 sej/J is the avg. for a U.S. citizen during avg. day.

13 TIMBERING

Services

Revenue from timber sales from 1973-1999 (26y) was \$250,000 (Wayah Ranger District, B. Cullpepper).

Revenue, \$/ha/y = 8.5

FuelsU.S. National average: 23 E15 J/y to harvest 648 E6 m³ of wood (see Table wood-log)U.S. National average J/m³= 3.55E+07Fuel use in WSC timbering, J/ha/y = (harvest, m³/ha/y)x(3.55E7 J/m³)

Fuel use in WSC timbering, J/ha/y = 1.56E+07

14 ROAD MAINTENANCE

Length of unpaved roads = 24 km (GIS database)

Length of paved roads = 9 km (GIS database, FS 711)

Footnotes to Table 3-2 (energy evaluation of Wine Spring Creek Watershed)

Cost to maintain roads	5,000 \$/mile/y (Bill Culpepper, FS Silviculturalist, Wayah Ranger District)
Cost of rd, \$/y =	(length of rds, km)x(\$5000/mile/y)x(1 mile/1.609 km)
Cost of rd, \$/y =	9.98E+04
Cost, \$/ha/y =	8.84E+01

15 FOREST SERVICE MANAGEMENT

Wayah Ranger District budget, \$/y	750000
Area of Wayah R.D., ha	56000
Expenditures, \$/ha/y =	13

16 RESEARCH EFFORT

At least 52 forest scientist, forest managers, university scientists and graduate students worked on the WSC Ecosystem Project from 1992-99. Assume they devoted 10% of their total work per year to gathering, analyzing, publishing and sharing their research

Effort, hr/y =	1.04E+04
Energy (J/ha) =	(____people-hrs/yr)*(104 Cal/hr)*(4186 J/Cal)/(1128 ha)
Energy (J/ha) =	4.01E+06
Transformity: post-college educated person (Odum 1996)	

INTERNAL PROCESSES

17 NET PRODUCTION OF LIVE BIOMASS

Roots+wood+leaves	14390 kg/ha/y; @ Coweeta Hydrologic Laboratory; Monk and Day, 1977,.
Energy(J) =	(NPP,kg/ha/y)x(area, ha)(1000 g/kg)(3.5 kcal/g-dry wt)(4186 J/kcal)
=	2.11E+11
Transformity = (empower of evapotranspiration + deep heat + atmos. dep.) / (net production)	

18 WOOD ACCUMULATION RATE

Net accumulation	4.20E+03 kg/ha/y; @ Coweeta Hydrologic Laboratory; Monk and Day, 1977,.
Energy(J) =	(net accum,kg/ha/y)x(area, ha)(1000 g/kg)(3.5 kcal/g-dry wt)(4186 J/kcal)
=	6.15E+10

Footnotes to Table 3-2 (emergy evaluation of Wine Spring Creek Watershed)

Transformity = (empower of evapotranspiration + deep heat + atmos. dep.) / (wood accumulation)

19 LITTERFALL

Net accumulation 4.40E+03 kg ha Avg. 1984-89. US Forest Service, 1990.
 Energy(J) = (Litterfall,kg/ha/y)x(area, ha)(1000 g/kg)(3.5 kcal/g-dry wt)(4186 J/kcal)
 = 6.45E+10

Transformity = (empower of evapotranspiration + deep heat + atmos. dep.) / (litterfall)

20 ROCK WEATHERING

Erosion rate, g/m²/y = 60 Velbel, 1988.
 Sediment lost, g/ha/y 6.00E+05
 Empower-to-flux (sej/g) = (empower of rain+deep heat+atmos. dep.) / (weathering rate)

21 TREE DIVERSITY

From the species-area curve, there were 30 species found within the first ha sampled.
 See Figure ____.

EXPORTS

22 Stream discharge

Runoff = 1.42 m/y mean 1995-96. Source: Coweeta Hydro. Lab

Chemical Energy(J) = (____ m²)*(____ m/y)*(1000 kg/m³)*(4940 J/kg)

Chemical Energy(J) = 7.03E+10

Chemical Energy (J/ha) =

Available geopotential energy (J) = (area)(runoff)(stream mouth elev above sea level)(density)(gravity)

= (____ m²)(____ m/y)*(____ m)*(1000 kg m⁻³)*(9.8m/s²)

Geopotential Energy (J) = 1.26E+11 relative to sea level

Runoff (g) = 1.424E+10

All transformities: [empower of rain + deep heat] / energy (or mass)

23 TIMBER EXTRACTION

Since 1973 (26 y), timber harvest from WSC watershed was 8623 m³ sawtimber and 4259 m³ of roundwood, valued at \$251,000 (Wayah Ranger District, courtesy of Bill Culpepper)

Footnotes to Table 3-2 (emergy evaluation of Wine Spring Creek Watershed)

Timber harvest rate, m ³ /ha/y =	0.44
Energy(J) =	(m ³)*(5 E5 g/m ³)*(4.5 Kcal/g)*(4186 J/Cal)
Energy(J) =	4.14E+09
Energy (J/ha) =	4.14E+09

Transformity of timber before harvest was based on simulation with EMERGYDYN for wood in Coweeta WS 18 (see Table 3-4)

Timber with services: services added were road maintenance, FS management, and timbering fuels and services.

Transformity of timber after harvest was emergy/energy

24 RECREATED PEOPLE

Same energy as visitor's length of stay above (#24)

Transformity = [sum of empower inputs / [metabolism of visitors during length of stay]

Empower inputs were sum of environmental and economic

Environmental inputs were taken as half the annual flow of rain+deepheat+atmospheric deposition since the main road is only opened from Apr. to Nov.

Economic inputs were sum of auto-fuel use, visiting time, road maintenance, and Forest Service management.

25 RESEARCH INFORMATION

From 1992 to 1998, 47 publications and 10 reports were produced (Swank 1999)

Publication rate over the six years was $57 / 6 = 9.5$ pubs/yr

Publications average 10 pages in length

Page weighs 1 gram

Grams of research articles published, g/y = 9.5 articles/y x 10 pages x 1 g/page

Grams of research articles published, g/y = 95

Energy of articles, J/y = grams x 3.5 kcal/g x 4186 J/kcal

Energy of articles, J/y = 1.39E+06

Energy of articles, J/ha/y = 1,234

Transformity = [sum of empower inputs (rain, deepheat, atmospheric deposition, road maintenance, Forest Service management, and research effort)]/[energy of publications, annual rate]

26 Total Export

Total export was rain + deep heat + atmos. deposition + all imported sources (items 10-18)

Footnotes to Table 3-4 (emergy of watershed storages)

1 Soil moisture

Soil water in 5.2m soil = 1.46 m Helvey and Patric, 1988.
 Depth of saprolite, m 6.1 Douglass and Swank, 1975.
 Cubic meters per ha = 17127
 Water chemical potential available (J) = (area)(rainfall)(density of water)(Gibbs no.)
 = (____m³(1000 kg/m³)*(4940 J/kg)
 = 8.46E+10

Emergy stored (sej) = (Accumulaton period of 2 y) x (annual empower: rain + deepheat, sej/y).

2 Wood

Wood stored per ha = 295 MT from model EMERGYDYN
 Energy(J) = (____ MT)(1E+06 g/MT)(19,200 J/g DW)
 = 5.66E+12

Emergy stored (sej) = 169 E15 sej/ha (based on simulation of EMERGYDYN)

3 Total Organic Matter

Total OM stored per ha = 1660 MT from model EMERGYDYN
 (____ MT)(1E+06 g/MT)(19,200 J/g DW)
 3.19E+13

Emergy stored (sej) = 795 E15 sej/ha (based on simulation of EMERGYDYN)

4 Calcium reserve

Ca reserve in live vegetation, kg/ha = 830 Monk and Day, 1989.
 Ca reserve in soil (extractable) and litter, kg/ha = 620 Monk and Day, 1989.

Emergy stored (sej) = (Accumulaton period of 200 y) x (annual empower:
 transpiration+deepheat+ atmospheric deposition, sej/y).

5 Saprolite

Depth of saprolite, m 6.1 Douglass and Swank, 1975.
 Per ha, m³ = 61000

Footnotes to Table 3-4 (emergy of watershed storages)

Density of sapr., g/cm³ : 1.5

Mass of saprolite = (vol., m³)x(1E6cm³/m³)x(1.5 g/cm³)

Mass of saprolite = 91.5E+9

Emergy stored (sej) = 3.6 E20 sej/ha (based on simulation of EMERGYDYN)

6 Tree species

Elliott and Hewitt (1997) observed 32 tree species in 3.5 ha at altitude > 1200m.

Based on simulations with EMSPECIES, ~70 tree species existed in the whole watershed, an average of 0.0621 species/ha.

Emergy accumulated based on EMSPECIES, was 2.6 E24 sej for 1128 ha or 2.31 E21 sej/ha.

STOP HERE

7 Forest tree bits

Based on EMSPECIES, 1763 bits (42 tree species) existed at 3.5 ha or 500 bits/ha.

Emergy accumulated based on EMSPECIES, was 131 E21 sej for 3.5 ha or 37.5 E21 sej/ha.

7 Forest tree bits	500 bits	4.6E+18	2,300,000	2.1E+09
--------------------	----------	---------	-----------	---------

Footnotes to Table 3-7 (emergy evaluation of Macon County, N.C.)

1 SOLAR ENERGY:

$$\begin{aligned}
 \text{Land Area} &= 1.34\text{E}+09 \text{ m}^2 \text{ (US Statistical Abstract 1995)} \\
 \text{Insolation @ Atmos} &= 6.31\text{E}+09 \text{ J/m}^2/\text{yr} \text{ (Barry \& Chorley, 1992, p. 23)} \\
 \text{Albedo} &= 0.15 \text{ fraction absorbed at surface (Barry \& Chorley, 1992, p. 23)} \\
 &= 3.15\text{E}+07 \quad 7.12\text{E}+09 \quad 225.65322 \\
 \text{Energy(J)} &= (\text{area incl shelf}) * (\text{avg insolation}) * (1 - \text{albedo}) \\
 &= (\text{ } \text{m}^2) * (\text{ } \text{J/m}^2/\text{y}) * (1 - \text{albedo}) \\
 &= 7.18\text{E}+18
 \end{aligned}$$

2 RAIN USED, CHEMICAL POTENTIAL ENERGY USED IN TRANSPIRATION:

$$\begin{aligned}
 \text{Land Area} &= 1.34\text{E}+09 \text{ m}^2 \\
 \text{Rain (land)} &= 1.35 \text{ m/yr} \text{ Water Information Center, 1973.} \\
 \text{Transpiration rate} &= 0.90 \text{ m/yr} \\
 \text{Energy (land) (J)} &= (\text{area})(\text{transpiration})(\text{Gibbs no.}) \\
 &= (\text{ } \text{m}^2) * (\text{ } \text{m}) * (1000 \text{ kg/m}^3) * (4940 \text{ J/kg}) \\
 \text{Total energy (J)} &= 5.96\text{E}+15
 \end{aligned}$$

3 GEOPOTENTIAL ENERGY in RAIN USED:

	<u>County</u>	
Area (m ²)	= 1.34E+09	(US Statistical Abstract 1995)
Rainfall (m/y)	= 1.35	Water Information Center, 1973.
Avg Elev (m)	= 340.00	From digital USGS 'DEM' coverages w/ ARCview
Runoff (m/y)	= 0.45	Water Information Center, 1973.

$$\begin{aligned}
 \text{Energy(J)} &= (\text{area})(\text{runoff})(\text{avg elevation})(\text{density})(\text{gravity}) \\
 &= (\text{ } \text{m}^2) * (\text{ } \text{m/y}) * (\text{ } \text{m}) * (1000 \text{ kg m}^{-3}) * (9.8 \text{ m/s}^2) \\
 &= 2.01\text{E}+15
 \end{aligned}$$

4 WIND ENERGY:	Jan.	Apr	July	Oct
Area, m ²	= 1.34E+09			
^a Eddy Diffusion, m ² /s	= 1.38	3.33	3.25	1.15
^a Vertical Gradient, m/s/m	= 0.0104	0.0069	0.0025	0.0037
(1000 m)(1.23 kg/m ³)(Eddy diffusion m ² /s)(7,884,000 sec/Qtr-yr)(Velocity Grad m/s/m) ² (area m ²)				
Energy/Qtr. (J)=	1.93E+15	2.05E+15	2.56E+14	2.05E+14

$$\text{Energy, Total (J/y)} = 4.43\text{E}+15 \text{ J/yr}$$

^a For Macon county, from Swaney, 1978.

WIND ENERGY ACCORDING TO "PROFILE METHOD" (see Table G-3)

$$\text{Energy, Total (J)} = 2.56\text{E}+16 \text{ J/yr}$$

5 VAPOR SATURATION DEFICIT

	Mean conditions	Effects of ET Difference
Atmos. pressure, mb	1000	1,000
Mean annual temp. (12.6	12.6

Footnotes to Table 3-7 (energy evaluation of Macon County, N.C.)

sat. vap. press.(e _s), mb	14.60	14.60	
sat. mix. ratio (q _s), g/kg	9.08	9.08	
Evapotranspiration (ET), g/y		1.21E+15	
Air exchange, m ³ /y		5.05E+16	
Depression of mix. ratio, g/kg		0.0199	
vapor press.(e), mb	12.20	12.23	0.0320
mix. ratio (q), g/kg	7.59	7.61	0.0199
sat. deficit (q _s -q), g/kg	1.49	1.47	-0.0199
sat. deficit (e _s -e), mb	2.39	2.36	-0.03
free energy, J/kg	198.3	195.7	-2.65
free energy, J/m ³	238.0	234.8	-3.18

Mean annual temperature at climate station CS01 in Coweeta basin.

Saturation vapor pressure (e_s), mb = $611 \cdot \text{EXP}((17.27 \cdot T)/(237.3 + T))/100$

Where T is mean annual temperature, C

Saturation mixing ratio, g/kg = $622 \cdot (e_s, \text{mb}) / (\text{air pressure, mb})$

Evapotranspiration, g/y = $(0.91 \text{ m/y}) \cdot (10,000 \text{ m}^2/\text{ha}) \cdot (1 \text{E}6 \text{ g/m}^3)$

Air exchange, see Table cow-wind

Depression of mix. ratio, g/kg = $(\text{ET, g/y}) / (\text{Air exchange, m}^3/\text{y}) / (1.2 \text{ kg/m}^3)$

mix. ratio, g/kg is mean annual for CS01

Vapor pressure, mb = $(\text{mixing ratio, g/kg}) \cdot (\text{air pressure, mb}) / 622$

sat. deficit, g/kg = sat. mix. ratio - mix. ratio

sat. deficit, mb = sat. vapor pressure - vapor pressure

free energy, J/kg = $-8.33 \cdot (273 + T) \cdot \text{LN}((1000 - q_s) / (1000 - q)) / 18 \cdot 100$

Free energy of air mass = $(8.33 \text{ J/mole/deg C}) \cdot (T \text{ deg C}) \cdot (\text{Loge}((1000 - \text{sat. mix. ratio, g/kg}) / (1000 - \text{mix. ratio, g/kg})) / (18 \text{ g/mole}) \cdot (1000 \text{ g/kg})$

Energy of the saturation deficit used, J/y = $(\text{difference in free energy, J/m}^3) \cdot (\text{air exchange, m}^3/\text{y})$

Energy of the saturation deficit used, J/y = $(\text{ } \text{J/m}^3) \cdot (\text{ } \text{m}^3/\text{y})$

Energy of the saturation deficit used, J/y: 1.61E+17

6 HISTORIC EROSIONAL LOSSES (based on forested land)

Annual erosion rate from forested land in Southern App., =

15 g/m² (Simmons, 1993.)

Loss (g/y) = $(\text{Area, m}^2) \cdot (\text{erosion rate, g/m}^2/\text{y})$

Loss (g/y) = 2.01E+10

7 GEOLOGIC UPLIFT

Land Area (m²) = 1.34E+09 Isostatic uplift from denudation rate

Uplift (cm/1000yr) = 4.0 of Southern Appalachians (Hack, 1980).

Height of Uplift, m = 940

Uplift (J/yr) = $(\text{uplift cm/1000y}) \cdot (2.6 \text{ g/cm}^3) \cdot (\text{area m}^2) \cdot (1 \text{m}/100 \text{cm}) \cdot (1 \text{e}6 \text{cm}^3/\text{m}^3) \cdot (0.5) \cdot (\text{ht. of uplift m}) \cdot (\text{gravity, } 9.8 \text{m/s}^2)$

Uplift (J/yr) = 6.42E+14

Footnotes to Table 3-7 (energy evaluation of Macon County, N.C.)

8 DEEP HEAT

$$\text{Land Area (m}^2\text{)} = 1.34\text{E}+09$$

$$\text{Heat flow / Area} = 1.36\text{E}+06 \text{ J/m}^2\text{/y, @ Bryson City, NC}$$

(Smith et al., 1981; in Pollack et al., 1991)

$$\text{Energy (J)} = (\text{heat flow/area}) \times (\text{land area})$$

$$\text{Energy (J)} = 1.82\text{E}+15$$

INDIGENOUS RENEWABLE ENERGY

9 HYDROELECTRICITY:

$$\text{Kilowatt Hrs/yr} = 2.45\text{E}+08 \text{ Federal Energy Regulatory Commission, 1981.}$$

$$\text{Energy(J)} = (\text{___ kWh/yr}) \times (3606\text{e}3 \text{ J/kWh})$$

$$\text{Energy(J)} = 8.85\text{E}+14$$

10 TOTAL ELECTRICITY USE:

$$\text{Kilowatt Hrs/yr} = (39,650 \text{ kWh/household in NC}) \times (9843 \text{ Households in Macon})$$

$$\text{Kilowatt Hrs/yr} = 3.90\text{E}+08 \text{ kWh/yr (1992)}$$

$$\text{Energy(J)} = (\text{___ kWh/yr}) \times (3606\text{e}3 \text{ J/kWh})$$

$$\text{Energy(J)} = 1.41\text{E}+15$$

11 AGRICULTURAL PRODUCTION:

$$\text{Ag. Prod} = 26,337 \text{ MT (1992 Census of Agriculture, NC.)}$$

$$\text{Energy(J)} = (\text{___ MT}) \times (1\text{E}+06 \text{ g/MT}) \times (3.5 \text{ Kcal/g}) \times (4186 \text{ J/Cal})$$

$$\text{Energy(J)} = 3.86\text{E}+14$$

12 LIVESTOCK PRODUCTION:

$$\text{L'stock Prod} = 2,285 \text{ MT (Cattle Sold, 1992 Census of Agriculture, NC.)}$$

$$\text{Cattle Sold} \times 1550 \text{ lbs/cattle}$$

$$\text{Energy(J)} = (\text{___ MT}) \times (1\text{E}+06 \text{ g/MT}) \times (2.82 \text{ Cal/g}) \times (4186 \text{ J/Cal})$$

$$= 2.70\text{E}+13$$

13 Forest Growth

$$\text{New Growth} = 4.42\text{E}+05 \text{ m}^3 \text{ 1983-89. USFS, 1990.}$$

$$\text{Energy(J)} = (\text{___ m}^3) \times (1\text{E}+06 \text{ g/m}^3) \times (0.5 \text{ g dry wt/g green wt}) \times (19,200 \text{ J/g dry wt})$$

$$= 4.25\text{E}+15$$

Transformity for annual wood growth at WS18 (see Table 3-1)

14 FOREST EXTRACTION

$$\text{Harvest} = 1.53\text{E}+05 \text{ m}^3 \text{ Avg. 1983-89. Forest statistics of North Carolina, 1990.}$$

$$\text{Energy(J)} = (\text{___ m}^3) \times (1\text{E}+06 \text{ g/m}^3) \times (0.5 \text{ g dry wt/g green wt}) \times (19,200 \text{ J/g dry wt})$$

$$= 1.47\text{E}+15$$

Footnotes to Table 3-7 (energy evaluation of Macon County, N.C.)

Transformity for wood at WS18 (see Table 3-4)

15 FUELWOOD USE:

Use, J/y = 2.87E+14 (see Table G-6)
 Energy(J) = 2.87E+14

NONRENEWABLE RESOURCE USE WITHIN MACON COUNTY

16 PRESENT EROSIONAL LOSSES

Annual sediment yield in Little Tennessee River = 80 g/m² (Simmons, 1993.)
 Loss (g/y) = (Area, m²)x(erosion rate, g/m²/y)

Loss (g/y) = 1.07E+11

17 GEMSTONES PRODUCTION

Production (\$/y) = \$ 50,000 (Minerals Yearbook, 1983, U.S.Dept. of Interior)

18 NON-FUEL MINERALS PRODUCTION

Production, 1981 (\$) = 1,406,000 (Minerals Yearbook, 1983, U.S.Dept. of Interior)

Price, 1981 (\$/MT) = 4

Production = 3.52E+05 MT/yr

Quantity (g) = (MT/y)*(1E6 g/MT)

= 3.52E+11

IMPORTS OF OUTSIDE ENERGY SOURCES:

19 PETROLEUM PRODUCTS

Imports of oil prod = 1.96E+15 J/y (see Table Mac-fuel)

Energy(J) = 1.96E+15

20 NATURAL GAS

Inconsequential amount, if any, used in county

21 COAL:

None used in county

22 ELECTRICITY IMPORTED

Imports = Consumption minus Production

Cons, J/y = 1.41E+15

Prod., J/y = 8.85E+14

Imports, J/y = 5.22E+14

23 LIVESTOCK

Imports =

Energy(J) = (1E5 MT/yr)*(1E6 g/MT)*(4 Kcal/g)*(4186 J/Kcal)*(.22 protein)

= 0.00E+00

24 NET IMMIGRATION

Footnotes to Table 3-7 (energy evaluation of Macon County, N.C.)

$$\begin{aligned} \text{Immigration} &= 503 \text{ people/yr, 1990-95. (U.S Census Bureau:county profiles, 1996)} \\ \text{Energy/person} &= 3.82\text{E}+09 \text{ J/y, energy expended per individual per day} = 2500 \text{ Cal/d} \\ \text{Energy(J)} &= (\text{ } \text{people/yr}) * (2500 \text{ Cal/d}) * (4186 \text{ J/Cal}) * (365 \text{ days/yr}) \\ &= 1.92\text{E}+12 \end{aligned}$$

25 MACHINERY, TRANSPORTATION, EQUIPMENT

$$\begin{aligned} \text{Auto \& truck registered} &= 20000 \\ \text{Assume lifetime} &= 10\text{y and replacements balance losses.} \\ \text{Purchases} &= 2.00\text{E}+03 \text{ autos per year} \\ \text{Mass (g)} &= (\text{ } \text{\#/y}) * (1.5 \text{ MT/aut}) * (1\text{E}6\text{g/MT}) \\ &= 3.00\text{E}+09 \end{aligned}$$

26 WOOD

$$\begin{aligned} \text{Imports} &= 0.00\text{E}+00 \text{ m}^3 \\ \text{Energy(J)} &= (\text{ } \text{m}^3) * (1\text{E}+06 \text{ g/m}^3) * (0.5 \text{ g dry wt/g green wt}) * (19,200 \text{ J/g dry wt}) \\ &= 0.00\text{E}+00 \end{aligned}$$

27 FEDERAL GOVERNMENT

$$\begin{aligned} \text{Personal Income, \$/y} &= 2.58\text{E}+08 \\ \text{Assume 15\% of Income paid in taxes and payout} &= \text{payin.} \\ &= 3.87\text{E}+07 \end{aligned}$$

28 IMPORTS OTHER THAN TOURISM

$$\begin{aligned} \text{Household Income, \$/y} &= 258.0\text{E}+6 \quad (\text{US Census Bureau, 1996}) \\ \text{Co. Income/m}^2 &= 0.192537 \quad 497.1\text{E}+3 \text{ \$/mi}^2 \\ \text{Import \$'s were proportional to income density} &= (\text{see M.T. Brown, 1980}). \\ \text{Dollar Value of non-tourism imports} &= \text{total imports less tourism} \\ \text{Dollar Value of non-tourism imports} &= \$25,800,000 \end{aligned}$$

29 TOURISM (input of tourist's time)

$$\begin{aligned} \text{Tourism to Macon Co. was based on extrapolating observed visitation rate to Wine Spring Creek} \\ \text{Visitation rate to WSC was 224,000 tourist-hrs in one year (1995-96, see Table WSC-tour).} \\ \text{Area of WSC, ha} &= 1,128 \\ \text{Visitation rate per ha} &= 198.6 \text{ tourist-hrs/year/hectare} \\ \text{Estimated visitation to Macon co., hours/year} &= (134,000 \text{ ha}) * (198.6 \text{ visitor-hr/ha/y}) \\ \text{visitor-hr/y} &= 2.66\text{E}+07 \\ \text{Energy, J/y} &= (\text{vis-hrs/y}) * (100\text{kcal/hr}) * (4186\text{J/kcal}) \\ \text{Energy, J/y} &= 1.11\text{E}+13 \end{aligned}$$

30 TOURISM (support of employment)

$$\begin{aligned} \text{Number of tourist related jobs in Macon Co. was 2000 (English 1995).} \\ \text{Assume mean per capita personal income in tourism equalled overall mean for Macon Co.} \\ \text{Mean income, \$/person/y} &= \$16,303 \text{ (NC Dept. of Commerce 1996)} \\ \text{Tourism Income in Macon, \$/y} &= \$32,606,000 \end{aligned}$$

EXPORTS OF ENERGY, MATERIALS AND SERVICES

31 TOBACCO

Footnotes to Table 3-7 (emergy evaluation of Macon County, N.C.)

Tobacco 6.00E+01 MT (NC Census of Ag., 1992)
 TOTAL 6.00E+01 MT

Energy(J) = (MT/yr)*(1E+06 g/MT)*(3.5 Cal/g)*
 (4186 J/Cal)
 = 8.79E+11

32 WOOD/WOOD PRODUCTS:

Fuelwood use = 2.87E+14 J/y
 Other use = (23,500 people) x (NC use/person, 28.6E9 J/y)
 Other use = 6.721E+14 J/y
 Production = 1.47E+15 J/y
 Consumption = fuelwood + Other use
 Exports = Prod - Cons = 507.6E+12 J/y
 Energy (J/y) = 5.08E+14

33 LIVESTOCK :

Est. consumption = 469 MT Est. mean NC per capita cons (44lbs) x population
 Production = 2,285 MT
 Exports = Prod - Cons
 Exports: = 1,816 MT

Energy(J) = (___ MT/yr)(1E6 g/MT)(4 Kcal/g)(4186 J/Cal)(.22 protein)
 = 6.69E+12

34 MINERALS :

Cons. per Capita = 3.25 MT/person, U.S. avg. 1995 (US Bureau of Mines)
 Consumption = 76375 MT Assume export = prod less consumption.
 Exports = 2.75E+05
 Energy (g) = (___ MT)*(1E6 g/MT)
 = 2.75E+11

35 SERVICES IN EXPORTS:

Gross State Prod. =
 Dollar Value =

36 FEDERAL GOVERNMENT

Assume \$ paid to federal gov't equal \$ received from fed. gov't
 0.00E+00
 0.00E+00 Imported monies must balance exported monies.

Footnotes to Table 3-9 (emergy evaluation of North Carolina)

1 SOLAR ENERGY:

$$\begin{aligned}
 \text{Cont Shlf Area} &= 2.5\text{E}+10 \text{ m}^2 \text{ at 150 m dpth., (est. from Goode's World Atlas, 1990).} \\
 \text{Land Area} &= 1.36\text{E}+11 \text{ m}^2 \text{ (US Statistical Abstract 1995)} \\
 \text{Insolation @ Atmo:} &= 6.31\text{E}+09 \text{ J/m}^2/\text{yr (Barry \& Chorley, 1992, p. 23)} \\
 \text{Albedo} &= 0.15 \text{ fraction absorbed at surface (Barry \& Chorley, 1992, p. 23)} \\
 &= 3.15\text{E}+07 \\
 \text{Energy(J)=} &= (\text{area incl shelf}) * (\text{avg insolation}) * (1-\text{albedo}) \\
 &= (\text{___ m}^2) * (\text{___ J/m}^2/\text{y}) * (1-\text{albedo}) \\
 &= 8.65\text{E}+20
 \end{aligned}$$

2 RAIN, CHEMICAL POTENTIAL ENERGY:

$$\begin{aligned}
 \text{Land Area} &= 1.36\text{E}+11 \text{ m}^2 \text{ (US Statistical Abstract 1995)} \\
 \text{Cont Shlf Area} &= 2.50\text{E}+10 \text{ m}^2 \text{ 150 m, (est. from Goode's World Atlas, 1990).} \\
 \text{Rain (land)} &= 1.27 \text{ m/yr Water Atlas of U.S., 1973.} \\
 \text{Rain (shelf)} &= 0.95 \text{ m/yr (est. as 75\% of tot. rain)} \\
 \text{Evapotrans rate=} &= 0.84 \text{ m/yr Water Atlas of U.S., 1973.}
 \end{aligned}$$

$$\begin{aligned}
 \text{Energy (land) (J)=} &= (\text{area})(\text{rainfall})(\text{Gibbs no.}) \\
 &= (\text{___ m}^2) * (\text{___ m}) * (1000 \text{ kg/m}^3) * (4940 \text{ J/kg}) \\
 &= 8.56\text{E}+17 \\
 \text{Energy (shlf) (J)=} &= (\text{area of shelf})(\text{Rainfall})(\text{Gibbs no.}) \\
 &= 1.18\text{E}+17 \\
 \text{Total energy (J)=} &= 9.74\text{E}+17
 \end{aligned}$$

3 RAIN, GEOPOTENTIAL ENERGY:

	<u>State</u> ^a	<u>Mountains</u> ^b	<u>Piedmont</u> ^b	<u>Coastal Plain</u>
Area, m ² =	1.26E+11	17.3E+9	55.3E+9	53.7E+9
Rainfall, m/y =	1.27	1.397	1.143	1.2192
Avg Elev., m =	214.00	1000	150	10
Min Elev., m =	0.00	600	10	0
Runoff rate, m/y =	0.43	1	0.4	0.4
Energy(J)=	1.14E+17	6.77E+16	3.03E+16	2.11E+15

a-US Statistical Abstract 1995, b-US Census Bureau, 21 Co.

a,b-Water Atlas of U.S., 1973. Water Information Center Publication.

a,b- USGS, Elevations & Distances in U.S., 1990, 1983.

Water Atlas of U.S., 1973. Water Information Center Publication.

$$\begin{aligned}
 \text{Energy(J)=} &= (\text{area})(\text{runoff})(\text{avg elevation})(\text{density})(\text{gravity}) \\
 &= (\text{___ m}^2) * (\text{___ m/y}) * (\text{___ m}) * (1000 \text{ kg m}^{-3}) * (9.8\text{m/s}^2)
 \end{aligned}$$

4 WIND ENERGY:

	Jan.	Apr	July	Oct
Area, m ² =	1.36E+11	1.36E+11	1.36E+11	1.36E+11
Eddy Diffusion, m ² /s =	1.38	3.33	3.25	1.15
Vertical Gradient, m/s/m =	0.0104	0.0069	0.0025	0.0037

Eddy Diffusion and Vertical Gradient from Swaney, 1978.

Footnotes to Table 3-9 (emergy evaluation of North Carolina)

Energy/Qtr. (J) = (1000 m)(1.23 kg/m³)(Eddy diffusion m²/s)(7,884,000 sec/Qtr-yr)(Velocity

Grad m/s/m²)(area m²)

Energy/Qtr. (J)= 1.96E+17 2.09E+17 2.60E+16 2.08E+16

Energy, Total (J)= 4.51E+17 J/yr

WIND ENERGY ACCORDING TO "PROFILE METHOD" (see Table D-4)

Energy, Total (J)= 5.41E+18 J/yr

5 SATURATION DEFICIT

Volume of air passing thru a 1000m tall prism over NC (see Table D-4)

Air flux, m³/y = 6.551E+18

Water evapotranspired (see Rain, Chemical energy above)

Mass of water, g/y : 1.15E+17

Increase in e (vapor pressure) is therefore (mass of water)/(air flux)

Assume that increase in e corresponds to commensurate decrease in vapor saturation deficit (d = e_s - e)

Decrease in d, g/m³ = 0.02

Energy of d, J/kg-air = (8.33 J/mol/K)x(300 K)/(18g/mol-water)x(1000g/kg)x[log_{nat}(1000-e_s)/(1000-e₁) - log_{nat}(1000-e_s)/(1000-e₂)]

Energy of d, J/kg-air 2.05

e_s, g/kg = 16.50 -LN((1000-C135)/(1000-C136+(C132/1.2)))

e₁, g/kg = 13.40

Energy used, J/y = energy of d, J/kg)x(1.2kg/m³)x(air flux, m³/y)

Energy used, J/y = 1.61E+19

6 HURRICANES

One hurricane every 4 yrs (NOAA, 1989); energy per hurricane = 9.6E15kcal/day

(Hughes, 1952), 3% kinetic,

10% delivered to surface system; mean duration = one day.

Energy/yr = (9.6e15 kcal/d) x (0.03) x (0.10) x (4186 J/kcal) x (1/4) x (1 d)

Energy(J)= 3.01E+16

7 WAVE ENERGY:

Shore length = 5.07E+05 m NCDEHNR, 1992.

velocity = [(gravity)(gauge depth)]^{1/2}

velocity, m/s = 1.4 estimated

Energy(J)=(shorelength, m) x 1/8 x (seawater density, kg/m³) x (gravity,

Energy(J)= 1.80E+16

8 TIDAL ENERGY:

Cont Shlf Area = 2.50E+10 m² 150 m, (est. from Goode's World Atlas, 1990).

Avg Tide Range = 1.10 m USGS, 1985.

Density = 1,025 kg/m³

Tides/year = 706 (estimated 2 tides/24.83 hr in one year)

Percent absorbed = 10% estimated

Footnotes to Table 3-9 (emergy evaluation of North Carolina)

Energy (J) on Shelf = (shelf)(0.5)(tides/y)(mean tidal range)²(density of
 Energy (J) on Shelf = (___m²)*(0.5)*(___/yr)*(___m)²(___kg/m³)(___%)*(9.8 m/s²)

Energy (J) on Shelf = 1.07E+16

Estuarine area = 7.99E+09 (NCDEHNR, 1992.)

Percent absorbed = 75% estimated

Estuarine Tidal

Range = 0.15 m USGS, 1985.

Energy (J) in Estuary = (estuarine area,m²)(0.5)(tides/y)(mean tidal range)²(density of

Energy (J), Estuary = 4.78E+14

Total tide energy = 1.12E+16

9 DEEP HEAT

Land Area (m²) = 1.36E+11

Heat flow / Area = 1.58E+06 J/m²/y, averaged from data in Pollock et al., 1991.

Energy, J/y = 2.16E+17

Land Area of Mtn (m²) = 1.73E+10

Energy of Mtn, J/y = 2.73E+16

10 HISTORIC LOSS OF SEDIMENTS VIA RIVERS

Historic loss was estimated based on a

Mean rate of sediment yield from forested basins in NC = 10.1 g/m²/y

Historic loss = 1.38E+12 g/y

INDIGENOUS RENEWABLE ENERGY**11 HYDROELECTRICITY:**

Kilowatt Hrs/yr = 5.81E+09 kWh (1992, US Statistical Abstract, 1995)

Energy(J) = (___kWh/yr)*(3606e3 J/kWh)

Energy(J) = 2.09E+16

12 AGRICULTURAL PRODUCTION:

Ag. Prod = 5.73E+06 MT (1992 Census of Agriculture, NC.)

Energy(J) = (___MT)*(1E06 g/MT)*(3.5 Kcal/g)*(4186 J/Cal)

Energy(J) = 8.40E+16

13 LIVESTOCK PRODUCTION:

L'stock Prod = 2,577,000 MT (1992 Census of Agriculture, NC.)

Energy(J) = (___MT)*(1 E6 g/MT)*(0.22 meat/live wt)(4.0 Cal/g)*(4186 J/Cal)

Footnotes to Table 3-9 (emergy evaluation of North Carolina)

$$= 9.49E+15$$

Caloric content used is average of beef, pork, poultry.

14 FISHERIES PRODUCTION:

$$\text{Fish Catch} = 74.8E+3 \text{ MT } 1993, (\text{National Marine Fisheries Service, 1995})$$

$$\begin{aligned} \text{Energy(J)} &= (\text{ } \text{ MT}) * (1 \text{ E6 g/MT}) * (0.22 \text{ meat/live wt}) * (4.0 \text{ Cal/g}) * (4186 \text{ J/Cal}) \\ &= 2.50E+14 \end{aligned}$$

15 FOREST GROWTH

$$\text{New Growth} = 4.95E+07 \text{ m}^3 \text{ 1983-89. Forest statistics of North Carolina, 1990 USFS.}$$

$$\begin{aligned} \text{Energy(J)} &= (\text{ } \text{ m}^3) * (1E+06 \text{ g/m}^3) * (0.5 \text{ g dry wt/g green wt}) * (19,200 \text{ J/g dry wt}) \\ &= 4.75E+17 \end{aligned}$$

Transformity: (see Table 3-12)

16 FOREST EXTRACTION

$$\text{Harvest} = 3.87E+07 \text{ m}^3 \text{ 1983-89. Forest statistics of North Carolina, 1990. USFS}$$

$$\begin{aligned} \text{Energy(J)} &= (\text{ } \text{ m}^3) * (1E+06 \text{ g/m}^3) * (0.5 \text{ g dry wt/g green wt}) * (19,200 \text{ J/g dry wt}) \\ &= 3.72E+17 \end{aligned}$$

Transformity from Table 3-1

17 FUELWOOD USE:

$$\text{Use} = 3.03E+06 \text{ m}^3 \text{ Avg. 1984-89. US Forest Service, 1990.}$$

$$\begin{aligned} \text{Energy(J)} &= (\text{ } \text{ m}^3) * (1E+06 \text{ g/m}^3) * (0.5 \text{ g dry wt/g green wt}) * (19,200 \text{ J/g dry wt}) \\ &= 2.91E+16 \end{aligned}$$

18 DIRECT WATER USE

$$\text{Tot. Cons., MGD} = 390 \text{ US Stat Abstract 1995}$$

$$\text{Energy (J/y)} = \text{MGD} * (365 \text{ d/y}) * (3.785E-3 \text{ m}^3/\text{gal}) * (5e6 \text{ J/m}^3)$$

$$\text{Energy (J/y)} = 2.69E+15$$

NONRENEWABLE RESOURCE USE WITHIN NORTH CAROLINA**19 PHOSPHATE ROCK**

$$\text{Production} = 5.50E+06 \text{ MT (U.S.Bureau of Mines, 1992)}$$

$$\begin{aligned} \text{Mass(g)} &= (\text{ } \text{ MT/y}) * (1E6 \text{ g/MT}) \\ &= 5.50E+12 \end{aligned}$$

20 PRESENT LOSS OF SEDIMENTS VIA RIVERS

Actual loss was estimated based on integration of Simmons (1993) work. (see [Table G-3.](#))

Mean rate of sediment yield from basins in NC = 37 g/m²/y

$$\text{Historic loss} = 5.05E+12 \text{ g/y}$$

21 TOTAL ELECTRICITY USE:

$$\text{Kilowatt Hrs/yr} = 9.55E+10 \text{ kWh/yr (1992) EIA, 1992. State Energy Data Report.}$$

$$\text{Energy(J)} = (\text{ } \text{ kWh/yr}) * (3606e3 \text{ J/kWh})$$

Footnotes to Table 3-9 (emergy evaluation of North Carolina)

$$\text{Energy(J)} = 3.44\text{E}+17$$

22 **NON-FUEL MINERALS (clays, feldspar, sand & gravel, stone)**

$$\text{Production} = 5.61\text{E}+07 \text{ MT/y} \text{ Sikich, S.W., P.A. Carpenter III, \& L.S. Wiener, 1992}$$

$$\begin{aligned} \text{Mass (g)} &= (\text{ MT/y}) * (1\text{E}6 \text{ g/MT}) \\ &= 5.61\text{E}+13 \end{aligned}$$

23 **TOPSOIL:**

$$\begin{aligned} \text{Soil loss on Ag. land, g/y} &= 4.30\text{E}+13 \\ \text{Soil gain on Forest land, g/y} &= 4.79\text{E}+13 \\ \text{Net soil gain, g/y} &= 4.91\text{E}+12 \\ \text{Energy, J/y} &= (\text{ g/yr}) * (0.03 \text{ organic}) * (5.4 \text{ Kcal/g}) * (4186 \text{ J/Kcal}) \\ &= \\ \text{Soil loss on Ag. land, J/y} &= 2.92\text{E}+16 \\ \text{Soil gain on Forest land, J/y} &= 3.25\text{E}+16 \end{aligned}$$

IMPORTS and OUTSIDE ENERGY SOURCES:

24 Oil Deriv. Prods.

$$\begin{aligned} \text{imports} &= 1.40\text{E}+08 \text{ (bbl/yr)} \quad (1992, \text{ US Statistical Abstract, 1995}) \\ \text{Energy(J)} &= (\text{ ___ bbl/yr}) * (6.28\text{e}9 \text{ J/bbl}) \\ &= 8.81\text{E}+17 \end{aligned}$$

25 NATURAL GAS

$$\begin{aligned} \text{Imports} &= 1.81\text{E}+11 \text{ (cu. ft./yr)} \quad (1992, \text{ US Statistical Abstract, 1995}) \\ \text{Energy(J)} &= (\text{ ___ cu. ft./yr}) * (1.10\text{e}6 \text{ J/cu. ft.}) \\ &= 1.99\text{E}+17 \end{aligned}$$

26 COAL:

$$\begin{aligned} \text{Imports} &= 24.1\text{E}+6 \text{ (short tons/yr)} \quad (1992, \text{ US Statistical Abstract, 1995}) \\ \text{Energy(J)} &= (\text{ ___ sh. tons/yr}) * (3.18\text{e}10 \text{ J/sh ton}) \\ &= 7.66\text{E}+17 \end{aligned}$$

27 NUCLEAR

$$\begin{aligned} \text{Kilowatt Hrs/yr} &= 2.26\text{E}+10 \text{ kWh/yr} \quad (1992, \text{ US Statistical Abstract, 1995}) \\ \text{Energy(J)} &= (\text{ ___ kWh/yr}) * (3606\text{e}3 \text{ J/kWh}) \\ \text{Energy(J)} &= 8.16\text{E}+16 \end{aligned}$$

28 LIVESTOCK

$$\begin{aligned} \text{Imports} &= 64313 \text{ MT/y} \text{ U.S. Census Bureau, 1998.} \\ \text{Energy(J)} &= (\text{ ___ MT/yr}) * (1\text{E}6 \text{ g/MT}) * (4 \text{ Kcal/g}) * (4186 \text{ J/Kcal}) \\ &= 1.08\text{E}+15 \end{aligned}$$

Footnotes to Table 3-9 (emergy evaluation of North Carolina)

29 AGRICULTURAL PRODUCTS

$$\begin{aligned} \text{Imports} &= 2.96\text{E}+06 \text{ MT/y} \\ \text{Energy(J)} &= (\text{MT}) \cdot (1\text{E}06 \text{ g/MT}) \cdot (3.5 \text{ Kcal/g}) \cdot (4186 \text{ J/Cal}) \\ \text{Energy(J)} &= 4.34\text{E}+16 \end{aligned}$$

30 NET IMMIGRATION

$$\begin{aligned} \text{Immigration} &= 6.40\text{E}+04 \text{ people/yr, avg. 1990-94. (US Statistical Abstract, 1995)} \\ \text{Energy/person} &= 3.82\text{E}+09 \text{ J/y, energy expended per individual per day} = 2500 \text{ Cal/d} \\ \text{Energy(J)} &= (\text{people/yr}) \cdot (2500 \text{ Cal/d}) \cdot (4186 \text{ J/Cal}) \cdot (365 \text{ days/yr}) \\ &= 2.44\text{E}+14 \end{aligned}$$

31 METALS

U.S. Consumption, 1992. (US Statistical Abstract, 1996)

Item	Quantity, 1E12 g/y
Iron Ore and Steel Scrap	138.9
Copper	2.8
Aluminum	7.3
Lead	1.5
Sum total	150.5

N.C. consumption assumed proportional to population, i.e., 2.68% of US Consumption.

$$\text{N.C. consumption} = 2.68\% \text{ of } 150.5\text{E}12 \text{ g/y} = 4.03\text{E}+12$$

32 WOOD (logs)

$$\begin{aligned} \text{Imports} &= 2.69\text{E}+06 \text{ m}^3 \text{ Johnson, T.G., 1994.} \\ \text{Energy(J)} &= (\text{m}^3) \cdot (1\text{E}+06 \text{ g/m}^3) \cdot (0.5 \text{ g dry wt/g green wt}) \cdot (19,200 \text{ J/g dry wt}) \\ &= 2.58\text{E}+16 \end{aligned}$$

33 MACHINERY, TRANSPORTATION, EQUIPMENT

Total value of U.S. shipments of machinery, transportation, electronics, and instrumentation equipment = 1.05e12 \$/y (US Census Bureau, 1992)

Total production hours used in these industries for U.S. = 7.66E9 hrs/y.

Therefore, value shipped per prod. hr = \$137/labor-hr.

NC had 1.81E6 surplus labor-hr in these industries based on having a consumption rate = to US average.

$$\text{NC import, } \$/\text{y} = \$137/\text{lab-hr} \times 1.81\text{E}6 \text{ lab-hr} = 2.48\text{E}+08$$

34 SERVICE IN OTHER IMPORTS

$$\begin{aligned} \text{Gross State Product} &= 160\text{E}+9 \\ \text{GSP/m}^2 &= 1.17 \\ \text{Total Dollar Value of imports} &= 1.47\text{E}+10 \\ \text{Dollar Value of other imports} &= (\text{total value}) \text{ less (value of machinery, etc)} \\ &= 1.45\text{E}+10 \end{aligned}$$

Imports are proportional to income density, M.T. Brown, 1980.

35 TOURISM :

$$\begin{aligned} \text{Dollar Value} &= 2.13\text{E}+09 \text{ US Travel Data Center, 1996} \\ &= 8.512\text{E}+09 \text{ Total travel expenditures in NC, 1994.} \\ \text{Dollar Value} &= 2.13\text{E}+09 \text{ Assume influx} = 25\% \text{ of state total expend.} \end{aligned}$$

Footnotes to Table 3-9 (emergy evaluation of North Carolina)

36 FEDERAL GOVERNMENT

Dollar Value = 2.89E+10 in 1994. (U.S. Statistical Abstract, 1995.)

EXPORTS OF ENERGY, MATERIALS AND SERVICES

37 TOBACCO

NC export = NC production less (US per capita consumption)x(NC population)

Tobacco 2.60E+05 MT/y (NC Census of Ag., 1992)

Energy(J) = (____ MT/y)*(1E+06 g/MT)*(3.5 Cal/g)*
(4186 J/Cal)

= 3.82E+15

38 FISHERY PRODUCTION:

Exports = 12.6E+3 MT 1993, (National Marine Fisheries Service, 1995)

Energy(J) = (____ MT)*(1E+06 g/MT)*(4 Cal/g)*(4186 J/Cal)(0.2 g dry/fresh)

= 4.23E+13

39 LIVESTOCK :

Exports: = 4.45E+05 MT/y see Table G-4

Energy(J) = (____ MT/yr)(1E6 g/MT)(4.0 Kcal/g)(4186 J/Cal)

= 7.46E+15

40 PHOSPHATE ROCK

Phosphate fertilizer use in NC Agriculture is 5.10E+11 g

Prod. - Cons. = 5.45E+06 MT/y

5.45E+12 g/y With Ag. use = 1%, then 99% of production is exported.

41 COTTON

NC export = NC production less (US per capita consumption)x(NC population)

Cotton export, MT/y = 3.55E+04

Energy(J) = (____ MT/y)*(1E+06 g/MT)*(3.5 Cal/g)*
(4186 J/Cal)

= 5.21E+14

42 CRUSHED STONE

Assume export = Prod - Cons.; Cons. = 2.6% of US total prod.

Exports = 2.58E+07 MT/y

Energy (g) = (____ MT)*(1E6 g/MT)

= 2.58E+13

43 LUMBER, FURNITURE, PAPER

Lumber, furniture, & paper export based on surplus labor-hrs used in production in NC.

Surplus labor-hrs = Labor-hrs used in NC production less (Labor-hrs per citizen x NC pop.)

Surplus labor-hrs = 220E6 lab.-hrs - (11.2 LH/pers)x(7E6 people); (US Census Bureau, 1992.)

Surplus labor-hrs/y = 1.42E+08

Footnotes to Table 3-9 (emergy evaluation of North Carolina)

Emergy per labor-hour (13E12 sej/LH), used as the "transformity," was the fuel+electricity emergy used in the U.S. wood products divided by the number of production hours worked, thus it excluded services(\$).

44 SERVICES IN EXPORTS:

Net Export of manufactured goods, \$/y 5.54E+10

45 FEDERAL GOVERNMENT

Assume the \$ of federal outlays equals income (see #36)

Footnotes to Table 3-10 (emergy evaluation of N.C. storages)

1 PHOSPHATE ROCK

Phosphate Rock Reserves (MT) =	1.00E+09 (U.S. Bureau of Mines, 1992)
% P =	10%
Reserves of phosphate (MT) =	100.0E+6
Reserves of phosphate (g) =	1.00E+14

2 GROUNDWATER

Area of Coastal Plain (m ²) =	6.8E+10	50% of State area
Avg. depth of Aquifers (m) =	75	est. based on Clay et al., 1975.
Est. mean porosity =	0.1	estimated
Storage (m ³) =	5.1E+11	
Energy (J) =	(_____ m ³)(1E+06 g/m ³)(4.94 J/g)	
Energy (J) =	2.519E+18	
Transformity based on analysis by A. Buenfil (UF dissertation forth coming)		

3 WOOD BIOMASS

Growing Stock	9.29E+08 m ³	
Avg. 1983-89. Forest statistics of North Carolina, 1990. US Forest Service.		
Energy (J) =	(_____ m ³)(1E+06 g/m ³)(0.5 g dry wt/g green wt)(19,200 J/g dry wt)	
=	8.92E+18	
Transformity based on analysis of Coweeta WS 18		

4 TOPSOIL

	Area, m ²	Topsoil (kg-org./m ²)
Forested	6.50E+10	15 (based on Coweeta soils)
Agriculture	3.20E+10	7.5 (assumed 50% of forest soils)
Organic Matter =	Area, m ² x _____ kg/m ² x 1000g/kg x 5.4 kcal/g x 4186 J/kcal	
Organic Matter, J =	2.75E+19	
Transformity based on analysis of Coweeta WS 18		

5 ECONOMIC ASSETS

Gross State Prod. =	1.60E+11 \$
5%/y depreciation	20 years
Economic Assets =	gross state product x 20 yrs
Economic Assets =	3.2E+12 \$

6 POPULATION

Population =	7.00E+06	1994, U.S. Bureau of the Census
Mean age (y) =	31	U.S. Average
People-years =	Population x mean age	
People-years =	2.17E+08	

7 SURFACE WATER

Reservoir storage (m ³) =	7.48E+09	NCDEHNR, 1992.
Energy (J) =	(_____ m ³)(1E+06 g/m ³)(4.94 J/g)	
Energy (J) =	3.7E+16	

Footnotes to Table 3-13 (energy of logging)

1 Services

Value of log shipments, \$/y = 13.8E+9 (US Census Bureau 1992)
 Value of log shipments, \$/m³ = (value of shipments,\$/y)/(log output,m³/y)
 Value of log shipments, \$/m³ = 23.78

2 Total Wages

Bureau of the Census: 1992 Economic Census:Census of Manufactures

3 Non-labor wages

Non-labor wages = Total wages less production workers wages.
 Production workers wages 1.31E+09
 Non-labor wages = 3.86E+08

4 Labor hrs

Hrs = 1.31E+08
 Bureau of the Census: 1992 Economic Census:Census of Manufactures
 Number of Prod. Workers : 69400
 40 hrs/wk x 52wk x 100kcal/hr x 4186 J/kcal
 Joules = 6.0426E+13

5 Capital Expenditures

New expenditures = 3.76E+08 \$
 @ 20 year life (5%) = 1.88E+07
 Bureau of the Census: 1992 Economic Census:Census of Manufactures

6 Biomass

Harvest = 6.47E+08 m³, 1991.
 US Forest Service, 1994. GTR-NC-169
 Energy(J) = (____ m³)(1E+06 g/m³)(0.5 g dry wt/g green wt)(19,200 J/g dry wt)
 = 6.21E+18
 Transformity of forest growth in NC (Table NC-forest).

7 Electricity

Electricity consumed, kWh 435.0E+6 Census Bureau, 1992.
 Electricity consumed, J/y = (____ kWh)x(3.61E6 J/kWh)
 Electricity consumed, J/y = 1.6E+15

8 Petroleum Fuels

Fuel used, \$/y = 152.0E+6 Census Bureau, 1992.
 Fuel used, J/y = (____ \$/y)x(1gal/\$)x(1bbl/42gal)x(6.28E9 J/bbl)
 Fuel used, J/y = 22.7E+15

Footnotes to Table 3-13 (emergy of logging)

9 Timber Output

Output of logs = Total Trees harvested x recovery rate

recovery rate = 90% assumed

10 Timber Output, transformity

Transformity of logs = sum of 1,6-10 divided by output energy of logs.

11 Emergy/\$ ratio for logs = sum of 1,6-10 divided by \$ value of log shipments.

Footnotes to Table 3-14 (emergy of pulpwood)

1 Services

Value of lumber shipments, \$/y =	5.47E+9 (US Census Bureau 1992)
\$ value of logs, \$/m ³ =	23.78 (Table wood-log)
\$ value of logs used for lumber, \$/y = (logs for lumber, m ³)x(\$/m ³)	
\$ value of logs used, \$/y =	3.76E+09
Services = \$ value of lumber sales less \$ value of logs	
Services, \$/y =	1.71E+09
Value of pulp shipments, \$/MT = (value of shipments,\$/y)/(pulp output, MT/y)	
\$ value of pulp, \$/MT =	94.41

2 Total Wages

Bureau of the Census: 1992 Economic Census:Census of Manufactures

3 Non-labor wages

Non-labor wages = Total wages less production workers wages.

Production workers wages = 501.6E+6 \$

Non-labor wages = 187.5E+6 \$

Bureau of the Census: 1992 Economic Census:Census of Manufactures

4 Labor hrs

Hrs = 26.3E+6

Number of Prod. Workers 12100

Joules = # of workers x 40 hrs/wk x 52wk x 100kcal/hr x 4186 J/kcal

Joules = 10.5E+12

Bureau of the Census: 1992 Economic Census:Census of Manufactures

5 Capital Expenditures

New expenditures = 772.3E+6 \$

@ 20 year life (5%) = 38.6E+6

Bureau of the Census: 1992 Economic Census:Census of Manufactures

6 Biomass

Roundwood used for pulp = 158.2E+6 m³, 1988. Ulrich, A.H., 1990.

$$\begin{aligned} \text{Energy(J)} &= (\text{_____ m}^3)(1\text{E}+06 \text{ g/m}^3)(0.5 \text{ g dry wt/g green wt})(19,200 \text{ J/g dry wt}) \\ &= 1.52\text{E}+18 \end{aligned}$$

7 Electricity

Kilowatt Hrs/yr = 2.54E+09 kWh/yr, 1991. EIA, 1991.

Energy(J) = (_____ kWh/yr)*(3606e3 J/kWh)

Energy(J) = 9.15E+15

8 Petroleum

Petroleum use = 4.80E+06 (bbl/yr) 1991. EIA, 1991.

Energy(J) = (_____ bbl/yr)*(6.28e9 J/bbl)

= 3.02E+16

9 Coal

Coal use = 3.31E+05 sh. tons, 1991. EIA, 1991.

Energy(J) = (_____ sh. tons/yr)*(3.18e10 J/sh ton)

= 1.05E+16

Footnotes to Table 3-14 (emergy of pulpwood)

10 Natural Gas

Natural gas use = 3.20E+10 cu. ft., 1991. EIA, 1991.
 Energy(J) = (___cu. ft./yr)*(1.10e6 J/cu. ft.)
 = 3.52E+16

11 Water use

Water use estimates from 241,000 Kraft-dissolve pulp
 Springer, 198? (liters per 53,000 Kraft-unbleached pulp
 M.T. produced) = 113,000 groundwood, chemimechanical pulp
 99,000 groundwood, thermomechanical pulp
 40,000 semichemical pulp
 244,000 sulfite pulp

Mix of production processes 42.5% Kraft-dissolve pulp
 % of total produced, 1988 34.9% Kraft-unbleached pulp
 (API, 1989) 4.7% groundwood, thermomechanical pulp
 5.0% groundwood, chemimechanical pulp
 7.1% semichemical pulp
 2.6% sulfite pulp
 3.2% other

Mean = (water use of i) x (fraction of production as i)
 Mean water use = 144,889 liters/M.T.

Water use (J) = (___MT)x(___liters/MT)x(0.001m³/liter)x(1E6g/m³)x(4940J/g)
 Water use (J) = 41.4E+15

12 Woodpulp output

Woodpulp production = 63.8E+6 short tons, 1988. Ulrich, A.H., 1990.
 Energy(J) = (___sh. tons/yr)x(1.0 MT/1.102 sh tons)x(1E6g/MT)x(3.5kcal/g)x(4186J/kcal)
 = 8.48E+17 J

13 Woodpulp output, transformity

Transformity of woodpulp = sum of 1,6-11 divided by output energy of woodpulp.

Footnotes to Table 3-15 (emergy of paperboard)

1 Services

Value of paperboard shipments, \$/y = 16.14E+9 (US Census Bureau 1992)
 \$ value of pulp, \$/MT = 94.41 (Table wood-pulp)
 \$ value of pulp used for paperbd, \$/y = (pulp, MT)x(\$/MT)
 \$ value of pulp used, \$/y = 3.26E+09
 Services = \$ value of paperboard sales less \$ value of pulp
 Services, \$/y = 1.29E+10

2 Total Wages

Bureau of the Census: 1992 Economic Census:Census of Manufactures

3 Non-labor wages

Non-labor wages = Total wages less production workers wages.
 Production workers wages = 1.5E+9 \$
 Non-labor wages = 601.4E+6 \$
 Bureau of the Census: 1992 Economic Census:Census of Manufactures

4 Labor hrs

Hrs = 88.4E+6
 Number of Prod. Workers 39400 employees
 Joules = # of workers x 40 hrs/wk x 52wk x 100kcal/hr x 4186 J/kcal
 Joules = 34.3E+12
 Bureau of the Census: 1992 Economic Census:Census of Manufactures

5 Capital Expenditures

New expenditures = 2.0E+9 \$
 @ 20 year life (5%) = 102.0E+6 \$
 Bureau of the Census: 1992 Economic Census:Census of Manufactures

6 Woodpulp

Woodpulp for paperbd = 31.3E+6 short tons, 1988. Ulrich, 1990.
 Energy(J) = (__sh. tons/yr)x(1.0 MT/1.102 sh tons)x(1E6g/MT)x(3.5kcal/g)x(4186J/kcal)
 = 4.16E+17 J
 Transformity from Table wood-pulp.

7 Recycled paper

Waste paper recycled = 8.6E+6 short tons, 1988. Ulrich, 1990.
 Energy(J) = (__sh. tons/yr)x(1.0 MT/1.102 sh tons)x(1E6g/MT)x(3.5kcal/g)x(4186J/kcal)
 = 1.14E+17 J
 Assume Transformity of recycled paper is same as virgin woodpulp.

8 Electricity

Kilowatt Hrs/yr = 1.04E+10 kWh/yr, 1991. EIA, 1991.
 Energy(J) = (____kWh/yr)*(3606e3 J/kWh)
 Energy(J) = 3.75E+16

Footnotes to Table 3-15 (energy of paperboard)

9 Petroleum

Petroleum use = (Paperboard Mill use of elect. per Paper Mill use of electricity, kWh)
x (petroleum use by Paper Mills, bbls)

$$\begin{aligned} \text{Petroleum use} &= 4.47\text{E}+06 \text{ (bbl/yr) 1991. Est. derived from EIA, 1991} \\ \text{Energy(J)} &= (\text{___bbl/yr}) \times (6.28\text{e}9 \text{ J/bbl}) \\ &= 2.81\text{E}+16 \end{aligned}$$

10 Coal

Coal use = (Paperboard Mill use of electricity per Paper Mill use of electricity, kWh)
x (Coal use by Paper Mills, sh. tons)

$$\begin{aligned} \text{Coal use} &= 2.74\text{E}+06 \text{ sh. tons, 1991. Est. derived from EIA, 1991.} \\ \text{Energy(J)} &= (\text{___sh. tons/yr}) \times (3.18\text{e}10 \text{ J/sh ton}) \\ &= 8.72\text{E}+16 \end{aligned}$$

11 Natural Gas

Natural gas use = (Paperboard Mill use of elect. per Paper Mill use of electricity, kWh)
x (natural gas use by Paper Mills, cu. ft.)

$$\begin{aligned} \text{Natural gas use} &= 8.00\text{E}+10 \text{ cu. ft., 1991. Est. derived from EIA, 1991} \\ \text{Energy(J)} &= (\text{___cu. ft./yr}) \times (1.10\text{e}6 \text{ J/cu. ft.}) \\ &= 8.80\text{E}+16 \end{aligned}$$

12 Water use

Water use estimates from	53,000 Kraft-unbleached
Springer, 1987 (liters per	40,000 semichemical
M.T. produced) =	151,000 Kraft-bleached
	30,000 recycled

Mix of production processes	47.9% Kraft-unbleached
% of total produced, 1988	15.9% semichemical
(API, 1989)	11.1% Kraft-bleached
	24.9% recycled

Mean = (water use of i) x (fraction of production as i)
Mean water use = 55,978 liters/M.T.

$$\begin{aligned} \text{Water use (J)} &= (\text{___MT}) \times (\text{___liters/MT}) \times (0.001\text{m}^3/\text{liter}) \times (1\text{E}6\text{g}/\text{m}^3) \times (4940\text{J}/\text{g}) \\ \text{Water use (J)} &= 9.6\text{E}+15 \end{aligned}$$

12 Paperboard output

$$\begin{aligned} \text{Paperboard production} &= 38.2\text{E}+6 \text{ short tons, 1988. Ulrich, 1990.} \\ \text{Energy(J)} &= (\text{___sh. tons/yr}) \times (1.0 \text{ MT}/1.102 \text{ sh tons}) \times (1\text{E}6\text{g}/\text{MT}) \times (3.5\text{kcal}/\text{g}) \times (4186\text{J}/\text{kcal}) \\ &= 5.08\text{E}+17 \text{ J} \end{aligned}$$

13 Paperboard output, transformity

Transformity of paperboard = sum of 1,6-12 divided by output energy of paperboard.

Footnotes to Table 3-16 (emergy of paper)

1 Services

Value of shipments, \$/y =	32.8E+9 (US Census Bureau 1992)
\$ value of pulp, \$/MT =	94.41 (Table wood-pulp)
\$ value of pulp used for paperbd, \$/y = (pulp, MT)x(\$/MT)	
\$ value of pulp used, \$/y =	3.26E+09
Services = \$ value of paper sales less \$ value of pulp	
Services, \$/y =	2.95E+10

2 Total Wages

Bureau of the Census: 1992 Economic Census:Census of Manufactures

3 Non-labor wages

Non-labor wages = Total wages less production workers wages.

Production workers wages = 3.9E+9 \$

Non-labor wages = 1.5E+9 \$

Bureau of the Census: 1992 Economic Census:Census of Manufactures

4 Labor hrs

Hrs = 215.2E+6

Number of Prod. Workers 100,400 number

Joules = # of workers x 40 hrs/wk x 52wk x 100kcal/hr x 4186 J/kcal

Joules = 87.4E+12

Bureau of the Census: 1992 Economic Census:Census of Manufactures

5 Capital Expenditures

New expenditures = 2.9E+9 \$

@ 20 year life (5%) = 145.6E+6 \$

Bureau of the Census: 1992 Economic Census:Census of Manufactures

6 Woodpulp

Woodpulp for paper = 31.3E+6 short tons, 1988. Ulrich, 1990.

Energy(J) = (__sh. tons/yr)x(1.0 MT/1.102 sh tons)x(1E6g/MT)x(3.5kcal/g)x(4186J/kcal)

= 4.16E+17 J

Transformity from Table wood-pulp.

7 Recycled paper

Waste paper recycled = 8.6E+6 short tons, 1988. Ulrich, 1990.

Energy(J) = (__sh. tons/yr)x(1.0 MT/1.102 sh tons)x(1E6g/MT)x(3.5kcal/g)x(4186J/kcal)

= 1.14E+17 J

Assume transformity of recycled paper is same as virgin woodpulp.

8 Electricity

Kilowatt Hrs/yr = 3.27E+10 kWh/yr, 1991. EIA, 1991.

Energy(J) = (___kWh/yr)*(3606e3 J/kWh)

Energy(J) = 1.18E+17

9 Petroleum

Petroleum use = 1.41E+07 (bbl/yr) 1991. EIA, 1991.

Energy(J) = (___bbl/yr)*(6.28e9 J/bbl)

= 8.85E+16

Footnotes to Table 3-16 (emergy of paper)

10 Coal

$$\begin{aligned} \text{Coal use} &= 8.63\text{E}+06 \text{ sh. tons, 1991. EIA, 1991.} \\ \text{Energy(J)} &= (\text{___ sh. tons/yr}) \times (3.18\text{e}10 \text{ J/sh ton}) \\ &= 2.75\text{E}+17 \end{aligned}$$

11 Natural Gas

$$\begin{aligned} \text{Natural gas use} &= 2.52\text{E}+11 \text{ cu. ft., 1991. EIA, 1991.} \\ \text{Energy(J)} &= (\text{___ cu. ft./yr}) \times (1.10\text{e}6 \text{ J/cu. ft.}) \\ &= 2.77\text{E}+17 \end{aligned}$$

12 Water use

Water use estimates from 133,000 Kraft-bleached fine papers
 Springer, 198? (liters per 91,000 groundwood-fine papers
 M.T. produced) = 220,000 sulfite-paper
 30,000 nonintegrated-fine paper

Mean = arithmetic average of above water use rates

Mean water use = 118,500 liters/M.T.

Water use (J) = (___MT)x(___liters/MT)x(0.001m³/liter)x(1E6g/m³)x(4940J/g)

Water use (J) = 20.7E+15

13 Paper output

Paper production = 38.9E+6 short tons, 1988. Ulrich, 1990.

$$\begin{aligned} \text{Energy(J)} &= (\text{___ sh. tons/yr}) \times (1.0 \text{ MT}/1.102 \text{ sh tons}) \times (1\text{E}6\text{g}/\text{MT}) \times (3.5\text{kcal}/\text{g}) \times (4186\text{J}/\text{kcal}) \\ &= 5.17\text{E}+17 \text{ J} \end{aligned}$$

14 Paper output, transformity

Transformity of paper = sum of 1,6-12 divided by output energy of paper.

Footnotes to Table 3-17 (emergy of plywood)

1 Services

Hardwood veneer & plywood (SIC-2435) shipments, \$ = 2.2E+09 (US Census 1992)

Softwood veneer & plywood (SIC-2436) shipments, \$ = 5.4E+09

\$ value of logs, \$/m³ = 23.78 (Table wood-log)

\$ value of logs used for plywood, \$/y = (logs for plywood, m³)x(\$/m³)

\$ value of logs used, \$/y = 1.14E+09

Services = \$ value of veneer & plywood sales less \$ value of logs

Services, \$/y = 6.55E+09

2 Total Wages

Hardwood veneer & plywood (SIC-2435) tot. wages, \$ = 3.9E+08

Softwood veneer & plywood (SIC-2436) total wages, \$: 8.3E+08

Bureau of the Census: 1992 Economic Census:Census of Manufactures

3 Non-labor wages

Non-labor wages = Total wages less production workers wages.

Hardwood V&P production workers wages, \$ = 285 E+6

Softwood V&P production workers wages, \$ = 705 E+6

Total Non-labor wages, \$ = 232 E+6

Bureau of the Census: 1992 Economic Census:Census of Manufactures

4 Labor hrs

Total production Hrs = 98.6E+6

Number of Prod. Workers, Hardwood V&P = 17,000

Number of Prod. Workers, Softwood V&P = 28,000

Joules = # of workers x 40 hrs/wk x 52wk x 100kcal/hr x 4186 J/kcal

Joules = 39.2E+12

Bureau of the Census: 1992 Economic Census:Census of Manufactures

5 Capital Expenditures

New expenditures = 145.7E+6 \$

@ 20 year life (5%) = 7.3E+6

Bureau of the Census: 1992 Economic Census:Census of Manufactures

6 Biomass

Roundwood used for lumber 4.80E+07 m³, 1988. CRB, 1993.

Energy(J) = (____ m³)(1E+06 g/m³)(0.5 g dry wt/g green wt)(19,200 J/g dry wt)

= 4.61E+17

Footnotes to Table 3-17 (emergy of plywood)

7 Electricity

The use of electricity and fuels in the plywood industry is assumed to have the same distribution of use in the wood products industry.

Fuel + electricity emergy of SIC-2435 & SIC-2436 =

[\$ value shipped (SIC-2435,-36)] x [sej (fuel+electricity) per \$ shipped (SIC-24)] sej

Fuel + elect. emergy used in Veneer & Plywood (SIC-2435,-36) = 1.3E+21

Distribution of fuel used in SIC-24 (Lumber & wood prod.)

	%	sej/y
Electricity	74.3%	1.03E+22
Petroleum	9.9%	1.36E+21
Coal	0.8%	1.16E+20
Natural Gas	14.9%	2.06E+21
Total	100.0%	1.38E+22

Electricity use = Fuel+elect. emergy of SIC-2435,-36 x % of total SIC-24 as elect.

Electricity use = 74.3% of 1.3 E21 sej

Electricity use = 964.6E+18 sej

8 Petroleum

Petroleum use = Fuel+elect. emergy of SIC-2435,-36 x % of total SIC-24 as petrol.

Petroleum used = 9.9% of 1.3 E21 sej.

Petroleum used = 128.3E+18 sej

9 Coal

Coal use = Fuel + electricity emergy of SIC-2435,-36 x % of total SIC-24 as coal

Coal use = 0.8% of 1.3 E21 sej

Coal use = 11.0E+18 sej

10 Natural Gas

Natural gas use = Fuel + electricity emergy of SIC-2435,-36 x % of total SIC-24 as N.G.

Natural gas use = 14.9% of 1.3 E21 sej

Natural gas use = 193.8E+18 sej

11 Plywood output

Plywood production = 2.21E+07 m³, 1993. CRB, 1996.

Energy(J) = (2.21E+07 m³)(1E+06 g/m³)(0.5 g dry wt/g green wt)(19,200 J/g dry wt)
= 212.2E+15

12 Plywood output, transformity

Transformity of plywood = sum of 1,6-10 divided by output energy of plywood.

Footnotes to Table 3-18 (emergy of lumber)

1 Services

Value of lumber shipments, \$/y =	2.11E+10 (US Census Bureau 1992)
\$ value of logs, \$/m ³ =	23.78 (Table 3-13)
\$ value of logs used for lumber, \$/y = (logs for lumber, m ³)x(\$/m ³)	
\$ value of logs used, \$/y =	5.67E+09
Services = \$ value of lumber sales less \$ value of logs	
Services, \$/y =	1.54E+10

2 Total Wages

Bureau of the Census: 1992 Economic Census:Census of Manufactures

3 Non-labor wages

Non-labor wages = Total wages less production workers wages.

Production workers wages = 2.4E+9 \$

Non-labor wages = 646.2E+6 \$

Bureau of the Census: 1992 Economic Census:Census of Manufactures

4 Labor hrs

Hrs = 249.1E+6

Number of Prod. Workers 118000

Joules = # of workers x 40 hrs/wk x 52wk x 100kcal/hr x 4186 J/kcal

Joules = 102.7E+12

Bureau of the Census: 1992 Economic Census:Census of Manufactures

5 Capital Expenditures

New expenditures = 457.1E+6 \$

@ 20 year life (5%) = 22.9E+6

Bureau of the Census: 1992 Economic Census:Census of Manufactures

6 Biomass

Roundwood used for lumber 2.39E+08 m³, 1988. CRB, 1993.

$$\text{Energy(J)} = (\text{_____ m}^3)(1\text{E}+06 \text{ g/m}^3)(0.5 \text{ g dry wt/g green wt})(19,200 \text{ J/g dry wt})$$

$$= 2.29\text{E}+18$$

Footnotes to Table 3-18 (emergy of lumber)

7 Electricity

The use of electricity and fuels in the sawmill industry is assumed to have the same distribution of use in the wood products industry.

Fuel + electricity (F&EL) of SIC-2421, sej/y =

$$[\$ \text{ value lumber sales (SIC-2421)}] \times [\text{sej}/\$ \text{ of (F\&EL of SIC-24)}]$$

F&EL used in sawmills (SIC-2421), sej/y = 3.6E+21

Distribution of fuel used in SIC-24 (Lumber & wood prod.)

	%	sej/y
Electricity	74.3%	1.03E+22
Petroleum	9.9%	1.36E+21
Coal	0.8%	1.16E+20
Natural Gas	14.9%	2.06E+21
Total	100.0%	1.38E+22

Electricity use = F&EL of SIC-2421(Sawmills) x % of total SIC-24 as electricity

Electricity use = 74.3% of 3.6 E21 sej

Electricity use = 2.6E+21 sej

8 Petroleum

Petroleum use = F&EL of SIC-2421(sawmills) x % of total SIC-24 as petrol.

Petroleum used = 9.9% of 3.55 E21 sej.

Petroleum used = 351.2E+18 sej

9 Coal

Coal use = F&EL of SIC-2421x % of total SIC-24 as coal

Coal use = 0.8% of 3.55 E21 sej

Coal use = 30.0E+18 sej

10 Natural Gas

Natural gas use = F&EL of SIC-2421x % of total SIC-24 as N.G.

Natural gas use = 14.9% of 3.55 E21 sej

Natural gas use = 530.5E+18 sej

11 Lumber output

Lumber production = 1.18E+08 m³, 1993. CRB, 1996.

$$\text{Energy(J)} = (\text{_____ m}^3)(1\text{E}+06 \text{ g/m}^3)(0.5 \text{ g dry wt/g green wt})(19,200 \text{ J/g dry wt})$$

$$= 1.1\text{E}+18$$

12 Lumber output, transformity

Transformity of lumber = sum of 1,6-10 divided by output energy of lumber.

APPENDIX B
CALIBRATION OF EMERGYDYN AND EMSPECIES

This appendix contains tables with footnotes documenting the calibration of EMERGYDYN for simulating wood (Table B-1), total organic matter (Table B-2), and saprolite (Table B-3) for the Coweeta watershed (ws18). Table B-4 documents the calibration of EMSPECIES for simulating tree species abundance and emergy values.

Table B-1. Calibration of EMERGYDYN for simulating biomass, energy, and transformity of wood in Coweeta watershed.

Note	Description	Variable	Equation	Calibration		
				Value	Units	k-value
1	Rainfall	R	constant	100	1×10^9 J/ha/y	n/a
2	Deep heat	G	constant	14	1×10^9 J/ha/y	n/a
3	Transformity of Rain	TR	constant	18000	sej/J	n/a
4	Transformity of deep heat	TG	constant	34000	sej/J	n/a
5	Wood biomass	Q		250	MT/ha	n/a
6	Runoff	Rr	$=R/(1 + k1*Q*G)$	55	1×10^9 J/ha/y	
7	Transpiration	J1	$=k1*Rr*G*Q$	45	1×10^9 J/ha/y	2.34E-04
8	Deepheat used	J5	$=k5*Rr*G*Q$	14	1×10^9 J/ha/y	7.27E-05
9	Wood feedback	J4	zero	0		
10	Gross wood production	J2	$=k2*Rr*G*Q$	17	MT/ha/y	8.83E-05
11	Wood export	J6	$=k6*Q$	2.5	MT/ha/y	1.00E-02
12	Wood depreciation	J3	$=k3*Q$	15	MT/ha/y	6.00E-02
13	Empower of rain	MR	$=TR*R$	1800	1×10^{12} sej/ha/y	n/a
14	Empower of deep heat	MG	$=TG*G$	476	1×10^{12} sej/ha/y	n/a
15	Empower of wood production	MJ2	$=MR + MG$	2276	1×10^{12} sej/ha/y	n/a

Notes to Table B-1

1 Rainfall

Rainfall averaged 2 m/y for Coweeta (Swift et al 1988)

Energy of rain, J/ha/y = (2 m/y)x(10,000m²/ha)x(1E6 g/m³)x(5 J/g)

Energy of rain, J/ha/y = 1E+11

2 Deep heat

Land Area (m²) = 1.00E+04

Heat flow / Area = 1.4E+06 J/m²/y, @ Bryson City, NC

(Smith et al., 1981; in Pollack et al., 1991).

Energy (J/ha/y) = (land area, m²)x(heat flow/area, J/m²/y)

Energy (J/ha/y) = 1.4E+10

3 Transformity of rain

Transformity of rain taken from Odum 1996

4 Transformity of deep heat

Transformity of heat flux through continents (Odum, 1996).

5 Wood biomass

Wood biomass in 1972, at least 50 years after heavy logging was 134 MT/ha. Monk and Day, 1988.

Assume by age 100 y, wood biomass would be 250 MT/ha.

Notes to Table B-1

6 Runoff

Runoff was 1.0 m/y from rainfall of 1.9 m/y, or ~55%.

55% of 2m/y = 1.1 m/y.

Energy of runoff, J/ha/y = $1.1\text{m/y} \times 1\text{E}4 \text{ m}^2/\text{ha} \times 5\text{E}6 \text{ J/m}^3 = 55 \text{ E}9$

7 Transpiration

Difference between rainfall and runoff = $2 - 1.1 = 0.9 \text{ m/y}$

Energy of transpiration, J/ha/y = $0.9\text{m/y} \times 1\text{E}4 \text{ m}^2/\text{ha} \times 5\text{E}6 \text{ J/m}^3 = 45 \text{ E}9$

8 Deep heat used

Deep heat used, was a proxy for geologic input (I.e., rock weathering, and land uplift)

Assume all of deep heat flux was used

9 Wood feedback

Gross production of wood was an autocatalytic function.

The energy flow of the feedback, although not zero in reality, was assumed negligible here.

Also, for convenience in calculating energy flow on a circular pathway, feedback energy was assumed to be zero.

10 Gross production of wood

Net production of wood in 1972, at least 50 y after heavy logging was 4.2 MT/ha/y (Monk and Day, 1988)

Estimate that gross wood production was 17 MT/ha/y when wood storage was 250 MT/ha

Notes to Table B-1

11 Wood export

Assume that wood export was 1% of wood biomass, or 2.5 MT/ha/y

12 Wood depreciation (respiration)

Assume that when wood biomass was 250 MT/ha, respiration was 90% of gross wood prod., or ~15 MT/ha/y.

13 Empower of rain

Empower of rain = Transformity of rain x energy of rainfall

14 Empower of deep heat

Empower of deep heat = Transformity of deep heat x energy of deep heat

15 Empower of gross wood production

Sum of rain and deep heat empower

Table B-2. Calibration of EMERGYDYN for simulating biomass, emergy, and transformity of total organic matter in Coweeta watershed.

Note	Description	Variable	Equation	Calibration		
				Value	Units	k-value
1	Rainfall	R	constant	100	1×10^9 J/ha/y	n/a
2	Deep heat	G	constant	14	1×10^9 J/ha/y	n/a
3	Transformity of Rain	TR	constant	18000	sej/J	n/a
4	Transformity of deep heat	TG	constant	34000	sej/J	n/a
5	Total organic matter (TOM)	Q		350	MT/ha	n/a
6	Runoff	Rr	$=R/(1 + k1*Q*G)$	55	1×10^9 J/ha/y	
7	Transpiration	J1	$=k1*Rr*G*Q$	45	1×10^9 J/ha/y	1.67E-04
8	Deepheat used	J5	$=k5*Rr*G*Q$	14	1×10^9 J/ha/y	5.19E-05
9	TOM feedback	J4	zero	0		
10	Gross TOM production	J2	$=k2*Rr*G*Q$	25	MT/ha/y	9.28E-05
11	TOM export	J6	$=k6*Q$	2	MT/ha/y	5.71E-03
12	TOM depreciation	J3	$=k3*Q$	8	MT/ha/y	2.29E-02
13	Empower of rain	MR	$=TR*R$	1800	1×10^{12} sej/ha/y	n/a
14	Empower of deep heat	MG	$=TG*G$	476	1×10^{12} sej/ha/y	n/a
15	Empower of TOM production	MJ2	$=MR + MG$	2276	1×10^{12} sej/ha/y	n/a

Notes to Table B-2

1 Rainfall

Rainfall averaged 2 m/y for Coweeta (Swift et al 1988)

Energy of rain, J/ha/y = (2 m/y)x(10,000m²/ha)x(1E6 g/m³)x(5 J/g)

Energy of rain, J/ha/y = 1E+11

2 Deep heat

Land Area (m²) = 1.00E+04

Heat flow / Area = 1.4E+06 J/m²/y, @ Bryson City, NC
(Smith et al., 1981; in Pollack et al., 1991).

Energy (J/ha/y) = (land area, m²)x(heat flow/area, J/m²/y)

Energy (J/ha/y) = 1.4E+10

3 Transformity of rain

Transformity of rain taken from Odum 1996

4 Transformity of deep heat

Transformity of heat flux through continents (Odum, 1996).

5 Total organic matter (TOM)

TOM (wood, roots, soil organic matter) in 1972, at least 50 years after heavy logging was 330 MT/ha. Monk and Day, 1988.

Round up to 350 MT/ha.

6 Runoff

Runoff was 1.0 m/y from rainfall of 1.9 m/y, or ~55%.

55% of 2m/y = 1.1 m/y.

Energy of runoff, J/ha/y = 1.1m/y x 1E4 m²/ha x 5E6 J/m³ = 55 E9

7 Transpiration

Difference between rainfall and runoff = 2 - 1.1 = 0.9 m/y

Energy of transpiration, J/ha/y = 0.9m/y x 1E4 m²/ha x 5E6 J/m³ = 45 E9

8 Deep heat used

Deep heat used, was a proxy for geologic input (I.e., rock weathering, and land uplift)

Assume all of deep heat flux was used

9 TOM feedback

Gross production of TOM was an autocatalytic function.

Energy flow of the feedback, although not zero in reality, was assumed negligible here.

Also, for convenience in calculating energy flow on a circular pathway, feedback energy was assumed to be zero.

10 Gross production of TOM

Net production of TOM in 1972, at least 50 y after heavy logging was 15 MT/ha/y (Monk and Day, 1988)

Based on observation estimate that gross production was 25 MT/ha/y when TOM storage was 350 MT/ha

Notes to Table B-2

11 TOM export

Assume that TOM export was less than 1% of TOM, ~2 MT/ha/y

12 TOM depreciation (respiration)

Assume that when TOM was 350 MT/ha, respiration was 30% of gross prod., or ~8 MT/ha/y.

13 Empower of rain

Empower of rain = Transformity of rain x energy of rainfall

14 Empower of deep heat

Empower of deep heat = Transformity of deep heat x energy of deep heat

15 Empower of gross TOM production

Sum of rain and deep heat empower

Table B-3. Calibration of EMERGYDYN for simulating saprolite, emergy, and emergy per mass of saprolite (regolith) in Coweeta watershed.

Note	Description	Variable	Equation	Calibration		
				Value	Units	k-value
1	Rainfall	R	constant	100	1×10^9 J/ha/y	n/a
2	Deep heat	G	constant	14	1×10^9 J/ha/y	n/a
3	Transformity of Rain	TR	constant	18000	sej/J	n/a
4	Transformity of deep heat	TG	constant	34000	sej/J	n/a
5	Saprolite	Q		91.5	1×10^9 g/ha	n/a
6	Rain not used in saprolite formation	Rr	$=R/(1 + k1*Q*G)$	1	1×10^9 J/ha/y	
7	Rain used in saprolite formation	J1	$=k1*Rr*G*Q$	99	1×10^9 J/ha/y	7.73E-02
8	Deepheat used	J5	$=k5*Rr*G*Q$	14	1×10^9 J/ha/y	1.09E-02
9	Saprolite feedback	J4	zero	0		
10	Gross saprolite production	J2	$=k2*Rr*G*Q$	0.57	1×10^9 g/ha/y	4.45E-04
11	Saprolite export	J6	$=k6*Q$	0.285	1×10^9 g/ha/y	3.11E-03
12	Saprolite depreciation	J3	$=k3*Q$	0.285	1×10^9 g/ha/y	3.11E-03
13	Empower of rain	MR	$=TR*R$	1800	1×10^{12} sej/ha/y	n/a
14	Empower of deep heat	MG	$=TG*G$	476	1×10^{12} sej/ha/y	n/a
15	Empower of saprolite production	MJ2	$=MR + MG$	2276	1×10^{12} sej/ha/y	n/a

Notes to Table B-3

1 Rainfall

Rainfall averaged 2 m/y for Coweeta (Swift et al 1988)

Energy of rain, J/ha/y = (2 m/y)x(10,000m²/ha)x(1E6 g/m³)x(5 J/g)

Energy of rain, J/ha/y = 1E+11

2 Deep heat

Land Area (m²) = 1.00E+04

Heat flow / Area = 1.4E+06 J/m²/y, @ Bryson City, NC

(Smith et al., 1981; in Pollack et al., 1991).

Energy (J/ha/y) = (land area, m²)x(heat flow/area, J/m²/y)

Energy (J/ha/y) = 1.4E+10

3 Transformity of rain

Transformity of rain taken from Odum 1996

Transformity of

4 deep heat

Transformity of heat flux through continents (Odum, 1996).

5 Saprolite (regolith)

Saprolite depth in Coweeta basin averaged 6.1 m. Douglass and Swank, 1975.

At a density of 1.5 g/cm³, that depth was the equivalent of 91.5 E9 g/ha

6 Rain not used in saprolite formation

Assume that nearly 100% of rainfall was used in saprolite formation.

Rain was either used as transpiration in production which accelerated rock weathering, or was runoff which carried acids and removed saprolite.

7 Rain used in saprolite formation

Assume that nearly 100% of rainfall (see above)

8 Deep heat used

Deep heat used, was a proxy for geologic input (i.e., rock weathering, and land uplift)

Assume all of deep heat flux was used

9 Saprolite feedback

Gross production of saprolite was an autocatalytic function.

Energy flow of the feedback, although not zero in reality, was assumed negligible here.

Also, for convenience in calculating energy flow on a circular pathway, feedback energy was assumed to be zero.

10 Gross production of saprolite

Velbel (1984) calculated that the rate of saprolite formation was 3.8 cm/1000y

Based on this observation and a density of 1.5 g/cm³, saprolite was being formed at 570,000 g/ha/y

11 Saprolite export

Without better data, assume that saprolite export was 50% of gross production

Notes to Table B-3

12 Saprolite depreciation

Assume that saprolite depreciation (dispersal) was 50% of gross production.

13 Empower of rain

Empower of rain = Transformity of rain x energy of rainfall

14 Empower of deep heat

Empower of deep heat = Transformity of deep heat x energy of deep heat

15 Empower of gross saprolite production

Sum of rain and deep heat empower

Table B-4. Calibration of EMSPECIES for simulating species abundance, stored emergy, and emergy per species in the WSC watershed.

Note	Description	Variable	Equation	Calibration		
				Value	Units	k-value
1	Rainfall per area	r	constant	100	1×10^9 J/ha/y	n/a
2	Deep heat	G	constant	14	"	n/a
3	Seed availability	C	constant	1	arbitrary units	
4	Transformity of Rain	TR	constant	18000	sej/J	n/a
5	Transformity of deep heat	TG	constant	34000	"	n/a
6	Empower per species	TC	constant	1.0×10^{20}	sej/y per tree species	n/a
7	Area	A	constant	0.08	ha	n/a
8	Biomass	V	state variable	28	MT per 0.08 ha	n/a
9	Tree species	S	state variable	9	species per 0.08 ha	
10	Rainfall	R	$r * \text{area}$	8		
11	Runoff	Rr	$=R/(1 + k1*S)$	5	1×10^9 J per 0.08 ha per y	
12	Transpiration	J1	$=k1*Rr*S$	3	"	6.67E-02
13	Deep heat used	J5	$=k5*V*G*C$	1.1	"	7.47E-02
14	Gross primary production	J2	$=k2*Rr*S$	2	"	4.44E-02
15	Species feedback	J4	negligible	0	"	
16	Unit respiration	J3	$=k3*V$	1.5	"	5.36E-02
17	Connectivity respiration	J6	$=k6*V*S^2$	0.4	"	1.76E-04
18	Recruitment respiration	J7	$=k7*V*G*C$	0.1	"	2.55E-04

Table B-4. continued.

Note	Description	Variable	Equation	Calibration		
				Value	Units	k-value
19	Species recruitment (gross)	J8	=k8*V*G*C	0.24	species per 0.08 ha per y	6.12E-04
20	Species loss (1st order)	J9	=k9*S	0.225	"	2.50E-02
21	Species loss (2nd order)	J13	=k13*S ²	0.015	"	1.85E-04
22	Empower of rain	MR	=TR*R	1800	1x10 ¹² sej/ha/y	n/a
23	Empower of deep heat	MG	=TG*G	476	"	n/a
24	Empower of new species	MC	=TC*C	1.0E+08	"	n/a
25	Empower of primary production	MJ2	=MR	1800	"	n/a
26	Empower contribution to tree species from biomass	MJ7	=TV*J7	variable	"	n/a
27	Empower of species recruitment	MJ8	=MJ7+MG+MC	variable	"	n/a

Notes to Table B-4

1 Rainfall per area

Rainfall averaged 2 m/y for Coweeta (Swift et al 1988)

Energy of rain, J/ha/y = (2 m/y)x(10,000m²/ha)x(1E6 g/m³)x(5 J/g)

Energy of rain, J/ha/y = 1E+11

2 Deep heat

Land Area (m²) = 1.00E+04

Heat flow / Area = 1.4E+06 J/m²/y, @ Bryson City, NC (Smith et al., 1981; in Pollack et al., 1991).

Energy (J/ha/y) = (land area, m²)x(heat flow/area, J/m²/y)

Energy (J/ha/y) = 1.4E+10

3 Seed availability

Availability was assumed constant

4 Transformity of rain

Transformity of rain taken from Odum 1996

5 Transformity of deep heat

Transformity of heat flux through continents (Odum, 1996).

6 Empower per species

Used Orrell's (1998) calculation of the annual empower per tree species in north central Florida.

7 Area

Calibration values were based on an area of 0.08 ha.

8 Biomass

28 MT per 0.08 ha is equivalent to 350 MT/ha, which was rounded up from Monk and Day's (1988) estimate of total organic matter for Coweeta WS18

9 Number of tree species

Calculated from Elliott and Hewitt's (1998) data.

10 Rainfall

Rainfall = rainfall per area x area

Notes to Table B-4

11 Runoff

Runoff was 1.0 m/y from rainfall of 1.9 m/y, or ~55%.

55% of 2m/y = 1.1 m/y.

Energy of runoff, J/ha/y = $1.1 \text{ m/y} \times 1 \text{ E}4 \text{ m}^2/\text{ha} \times 5 \text{ E}6 \text{ J/m}^3 = 55 \text{ E}9$

Energy of runoff, J per 0.08 ha per y = $55 \text{ E}9 \text{ J/ha/y} \times 0.08 = \sim 5 \text{ E}9 \text{ J}$

12 Transpiration

Difference between rainfall and runoff = $2 - 1.1 = 0.9 \text{ m/y}$

Energy of transpiration, J/ha/y = $0.9 \text{ m/y} \times 1 \text{ E}4 \text{ m}^2/\text{ha} \times 5 \text{ E}6 \text{ J/m}^3 = 45 \text{ E}9$

Energy of transpiration, J per 0.08 ha per y = $45 \text{ E}9 \text{ J/ha/y} \times 0.08 = \sim 3 \text{ E}9 \text{ J}$

13 Deep heat used

Deep heat used, was a proxy for geologic input (i.e., rock weathering, and land uplift)

Energy of deep heat, J per 0.08 ha per y = $14 \text{ E}9 \text{ J/ha/y} \times 0.08 = \sim 1.1 \text{ E}9 \text{ J}$

14 Gross production of biomass

Net production of TOM in 1972, at least 50 y after heavy logging, was 15 MT/ha/y (Monk and Day, 1988)

Based on the observation, gross production was estimated to be 25 MT/ha/y (2 MT/0.08ha/y) when TOM storage was 350 MT/ha

15 Species feedback

Gross production of biomass was a function of rain energy and tree species.

The energy flow of the feedback, although not zero in reality, was assumed negligible here.

Also, for convenience in calculating energy flow on a circular pathway, feedback energy was assumed to be zero.

16 Unit respiration

Unit respiration represented the energetic expense of the units as if in isolation, and was a function of biomass only

Total respiration was calibrated equal to gross production, unit respiration was assumed to be

75% of total respiration.

17 Connectivity respiration

Notes to Table B-4

Connectivity respiration was the energetic expense of maintaining the interactions between tree species.
It was assumed to be 20% of total respiration at steady state

18 Recruitment respiration

Recruitment respiration was the energetic expense to recruit new tree species
It was assumed to be 5% of total respiration at steady state

19 Species recruitment

Gross tree species recruitment was assumed to equal 3 species per ha per year (0.24 per 0.08 ha)

20 Species loss (1st order)

Species exit the ecosystem as a 1st order (linear) function of the species present.

Total species loss balanced species recruitment. 1st order loss was assumed to equal ~95% of total species loss

21 Species loss (2nd order)

Species exit the ecosystem as a 2nd order (quadratic) function of the species present (a "crowding effect").

Equaled 5% of total species loss.

22 Empower of rain

Empower of rain = Transformity of rain x energy of rainfall

23 Empower of deep heat

Empower of deep heat = Transformity of deep heat x energy of deep heat

24 Empower of new species

Empower of new species = Empower per tree species (north central Florida) x species recruitment

25 Empower of primary production

Empower of rain only

26 Empower contribution to tree species from biomass

Empower from biomass to tree species was transformity of biomass x recruitment respiration

27 Empower of species recruitment

Sum of empower from recruitment respiration, deep heat, and new species

APPENDIX C WATER VAPOR SATURATION DEFICIT OF THE ATMOSPHERE OVERLYING LAND

The mean solar transformity of the water vapor saturation deficit e_{sd} was calculated to be 590 sej/J. The following sections explain how the transformity was derived.

Introduction

The water vapor saturation deficit (e_{sd}) is well known to be a major factor in forest transpiration and has been strongly correlated with gross primary productivity of forest ecosystems (Odum 1970). Prior to this study, the solar transformity of e_{sd} had not been calculated, and therefore, the emergy contribution of e_{sd} to ecosystems could not be determined. Here, the mean annual value of the atmosphere's water vapor saturation deficit over the continents was calculated and used to determine a globally averaged solar transformity for e_{sd} . The solar transformity of e_{sd} was applied in the emergy evaluations of the Southern Appalachian watersheds (Coweeta and Wine Spring Creek), the county of Macon, N.C., and the state of North Carolina.

Methods

The water vapor saturation deficit e_{sd} is the difference between the water vapor saturation pressure e_s and the water vapor pressure e_a

$$e_{sd} = e_s - e_a \quad (1)$$

The vapor saturation pressure, the maximum amount of vapor a parcel of air will hold, is a function of temperature T as given by the Clausius-Clapeyron equation (Schneider 1996)

$$de_s/dT = e_s L M_w/R T^2, \quad (2)$$

where L = latent heat of phase transition, $M_w = 18.0$ is average molecular weight of water, $R = 8.33 \times 10^3$ Joules per Kelvin per mole is the ideal-gas constant, and T is absolute temperature.

The equation can be integrated and simplified to an approximate form (Chow et al. 1988)

$$e_s = 6.11 \cdot \exp[(17.27 \cdot T)/(237.3 + T)] \quad (3)$$

where e_s is in millibars, T is in degrees Celsius, and \exp means raise the base of the natural logarithm (2.718) by the bracketed expression.

Energy at the Surface (1000 mb)

The mean annual value of the saturation deficit over the continents at the surface (1000 mb) was estimated based on the mean monthly temperature and vapor pressure presented in a 0.5° latitude by 0.5° longitude resolution climatology for land areas, excluding Antarctica, for the period 1961-1990. The 'Global Climate Dataset' was compiled by the Climate Research Unit of the United Nations Intergovernmental Panel on Climate Change and distributed by their Data Distribution Centre (New et al. 1998).

Mean monthly water vapor saturation pressure for each grid was approximated with Eq. (3), which was then used in Eq. (1) to figure the water vapor saturation deficit.

The mean zonal value (i.e., per latitude) for the saturation deficit over land was figured by summing the monthly values at each latitude and dividing by the total area of

land at that latitude. The mean saturation deficit for all land was found by summing the monthly sums across all latitudes and dividing by the total area of land represented in the dataset.

Meridional Profiles of the Vertical Distribution of the Saturation Deficit

For each 10 degree interval of latitude an equation was developed for figuring the saturation deficit at a given altitude. The estimates for the surface (1000mb) and 850 mb were combined with the minimum values (i.e., those found at the highest altitudes) to develop a linear regression model. The saturation deficit at the surface (1000 mb) was determined as previously described. At the 850 mb level, the saturation deficit was based on the meridional profile of relative humidity (Peixoto and Oort 1996) and temperature (Haurwitz and Austin 1944) over land. The relative humidity U is

$$U = e_a / e_s \quad (4)$$

The minimum saturation deficit occurs at the highest altitudes. For the analysis the minimum vapor saturation deficit for each latitude was estimated based on the cross-section of the saturation mixing ratio given for the whole globe (ocean plus land) (Peixoto and Oort 1996). The saturation vapor pressure deficit can be approximated from the difference between saturation mixing ratio (q_s) and the mixing ratio (q) by

$$e_{sd} = p/622 \cdot (q_s - q) \quad (5)$$

Where p = atmospheric pressure in millibars, q_s is saturation mixing ratio in g/kg, and q is mixing ratio in g/kg.

Results

Systems Diagram of the Global Water Vapor Saturation Deficit

Figure C-1 shows the systems diagram highlighting the role of the water vapor saturation deficit in controlling the hydrologic cycle between sea, atmosphere, and land. The storages of heat (T_M , T_L) and water vapor (e_M , e_L) in the global atmosphere were separated into marine (M) and continental (L) components due to their distinctly different attributes. Marine air is generally more moist than continental air. In the sea, the sun, ocean water, tide, and the deep heat of the earth interact with the marine atmosphere to produce more atmospheric vapor and heat. In the atmosphere, the marine and continental air masses interact, accelerated by the deep heat of earth driving the land cycle, to produce rain over land and sea. On land, plant transpiration is driven by water availability, the water vapor saturation deficit (a function of the difference between T_L and e_L), and the land cycle. Water not used in transpiration or evaporated is discharged to the sea.

Energy at the Surface (1000 mb)

The seasonal distribution of the saturation deficit e_{sd} for the globe can be seen in the world maps (Figures C-2a and C-2b). In June, the saturation deficit was greatest in the deserts of North Africa, northern Australia, and southwestern North America. (Note: data was missing between meridians 45°E-80°E and 105°E-120°E for June, Figure C-2a). In December, e_{sd} was greatest in North Africa, Australia, south central South America, the Arabian peninsula, southern Africa, and western India. The vapor saturation deficit generally was greatest near the equator and decreased poleward.

The mean annual saturation deficit for the Northern Hemisphere (7.31 mb) was less than the 8.89 mb mean for the Southern Hemisphere. However, the mean annual meridional distribution for the Northern Hemisphere had a much higher peak (~ 20 mb near 15°N , Figure C-3) than any latitude in the Southern Hemisphere. For the June-August period (JJA), the global distribution was much more uneven between the Southern and Northern hemispheres.

In Figure C-4 the annual cycle of mean monthly vapor saturation deficit is shown for the Southern Hemisphere (SH), Northern Hemisphere (NH), and the globe. The cycles for the hemispheres were out of phase with the SH peaking in November-January and the NH doing so in June-July. Globally, the period of maximum vapor deficit was June-July.

Vertical Distribution of the Saturation Deficit

Figure C-5 is a graph of the data presented in Table C-1. Figure C-5 shows the meridional profiles of the vapor saturation deficit (e_{sd}) for altitudes from ground surface (1000 mb) up to 350 mb. The e_{sd} decreased with altitude at all latitudes, but at varying rates. Above 350 mb the e_{sd} was less than 1 mb.

Figure C-6 presents a graph of the data shown in the final column of Table C-2. Figure C-6 shows the meridional distribution of the vertically integrated, mean annual energy of the saturation deficit. Globally, it was greatest at 20°N , but had a local maximum at 20S . The e_{sd} dipped to a local minimum at the equator.

Figure C-7 shows the vertical distribution of the vapor saturation deficit (e_{sd}) over the continents. The e_{sd} declined with altitude from 7.8 mb at the surface (1000 mb) to near zero at 350 mb. This was an average of 0.74 mb per 1000 m of altitude.

Transformity of the Saturation Deficit over Land

The solar transformity of the earth's mean water vapor saturation deficit over land was 590 sej/J (Table C-3). The mean annual energy of the saturation deficit of the atmosphere overlying the continents was 361 E18 J. On average, the water vapor of the atmosphere is replaced every 8.2 days (UNESCO 1978), hence, the annual flow of energy necessary to support this storage is $(361 \text{ E18 J}) / (8.2 \text{ d}) \times (365 \text{ d}) = 16 \text{ E21 J/y}$.

Supposing that the total energy budget of the globe was required to maintain this energy flow, the global transformity of the saturation deficit over land was estimated as $(9.44 \text{ E24 sej/y}) / (16 \text{ E21 J/y}) = 590 \text{ sej/J}$.

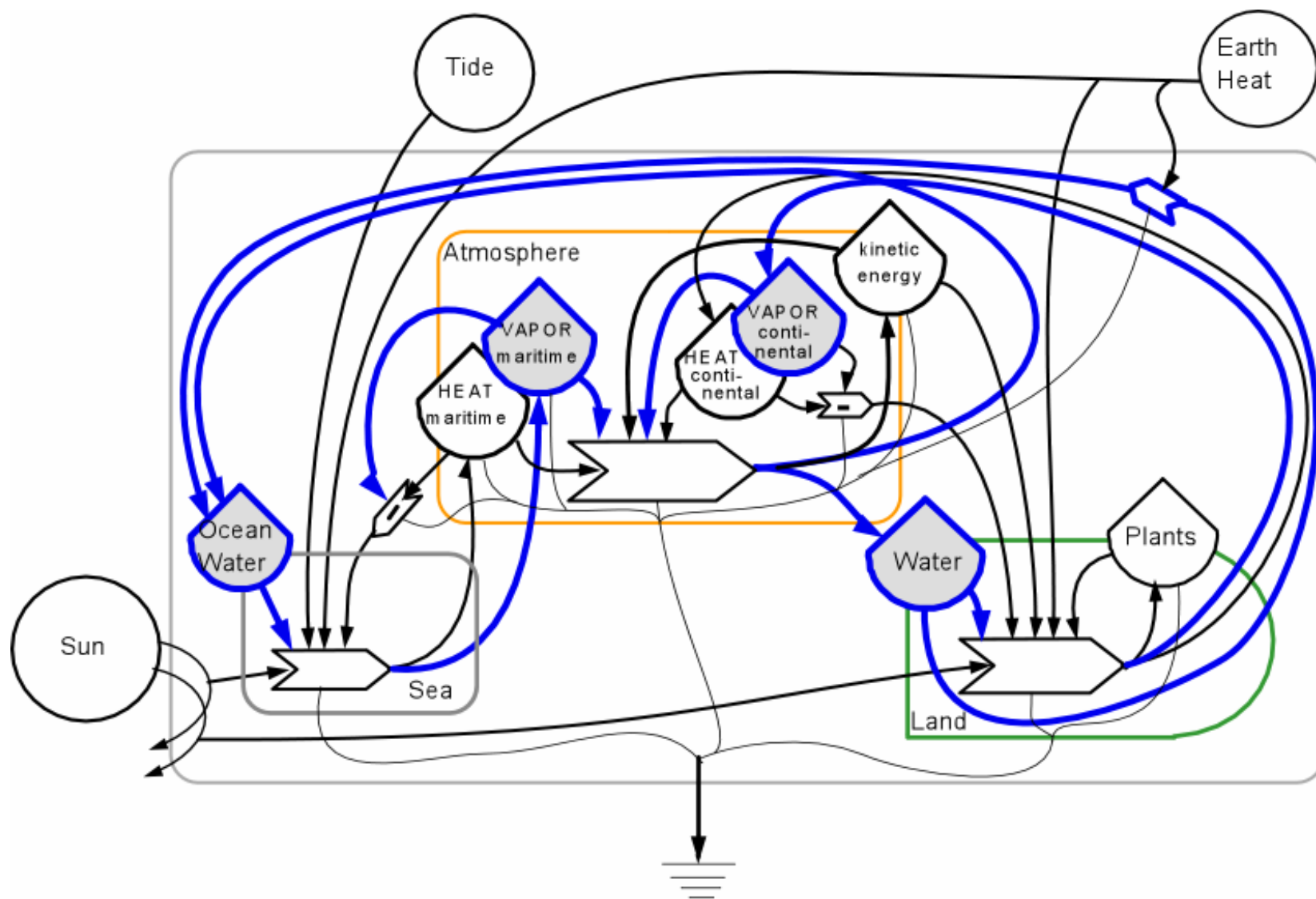
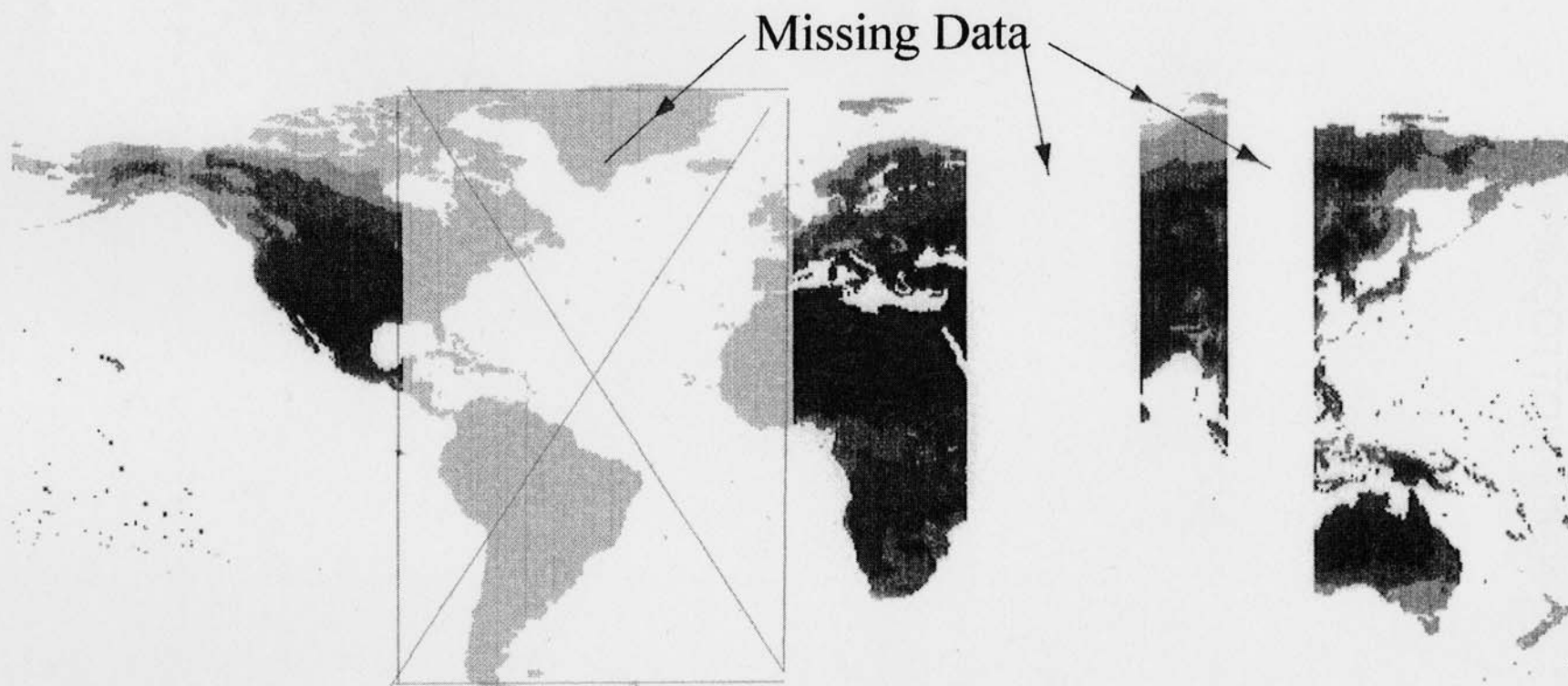

Figure C-1. Systems diagram of the hydrologic cycle overlaid with the heat budget of the atmosphere highlighting the role of the water vapor saturation deficit over land.



Mean vapor saturation deficit (mb x 100) at surface (1000 mb) for June (1961-90)

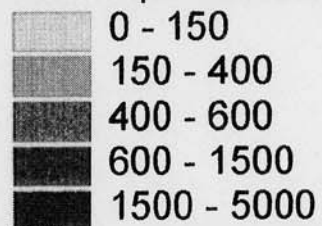
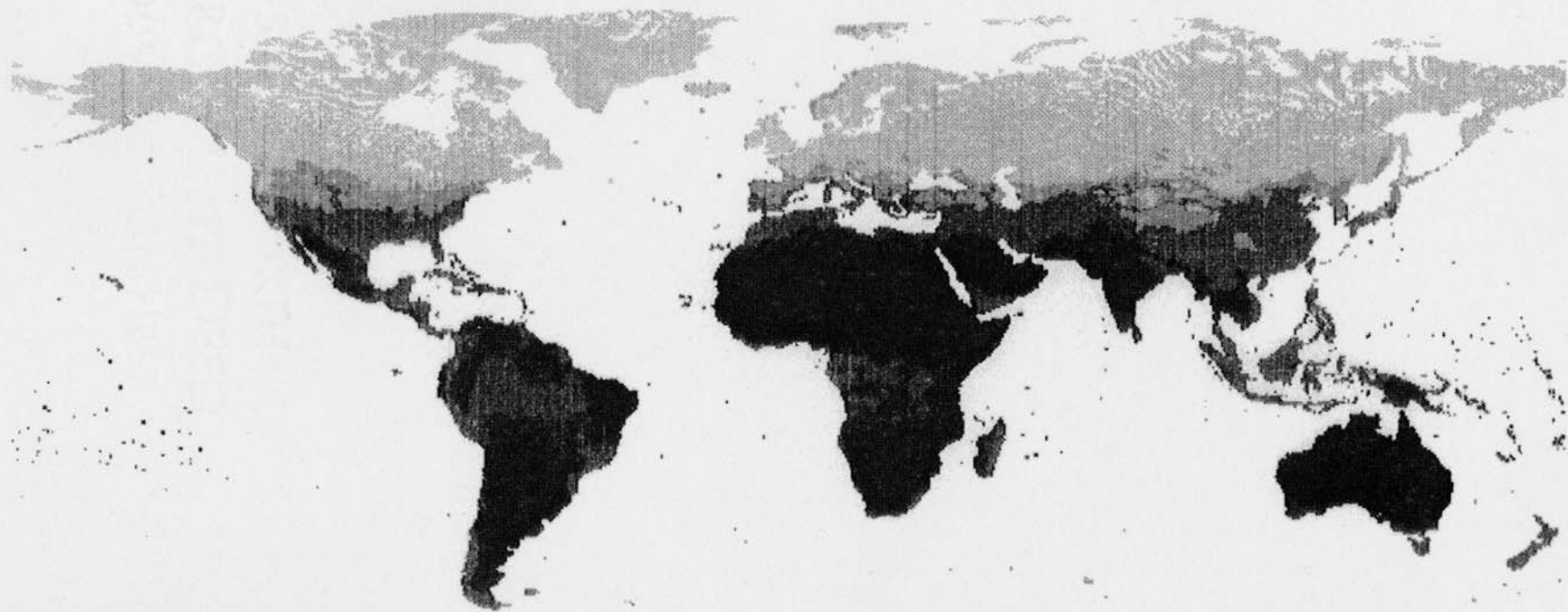

Figure C-2a. Average annual atmospheric water vapor saturation deficit for 1000 mb for period 1961-1990.



Mean vapor saturation deficit (100 x mb)
at surface for December for period 1961-1990.

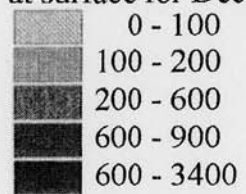

Figure C-2. continued.

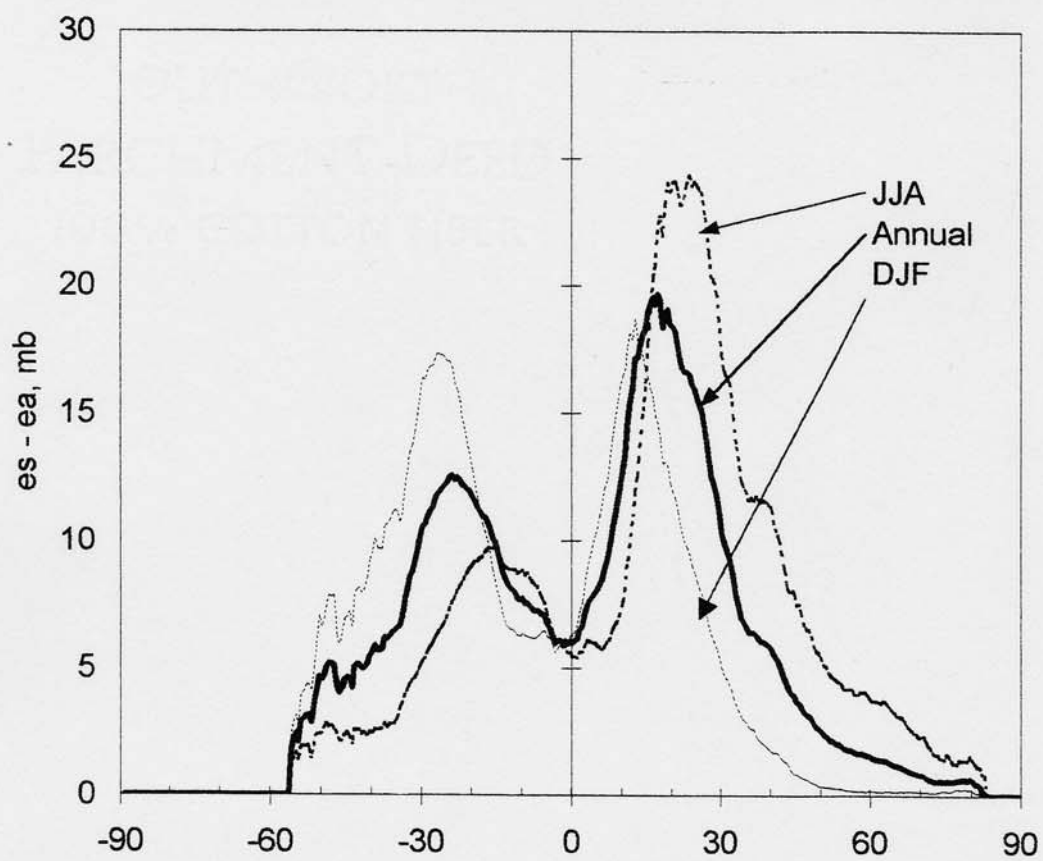

Figure C-3. Annual and seasonal meridional profiles of the mean zonal water vapor saturation deficit (mb) at the surface of the continents. (DJF--Dec, Jan, Feb; JJA--Jun, July, Aug).

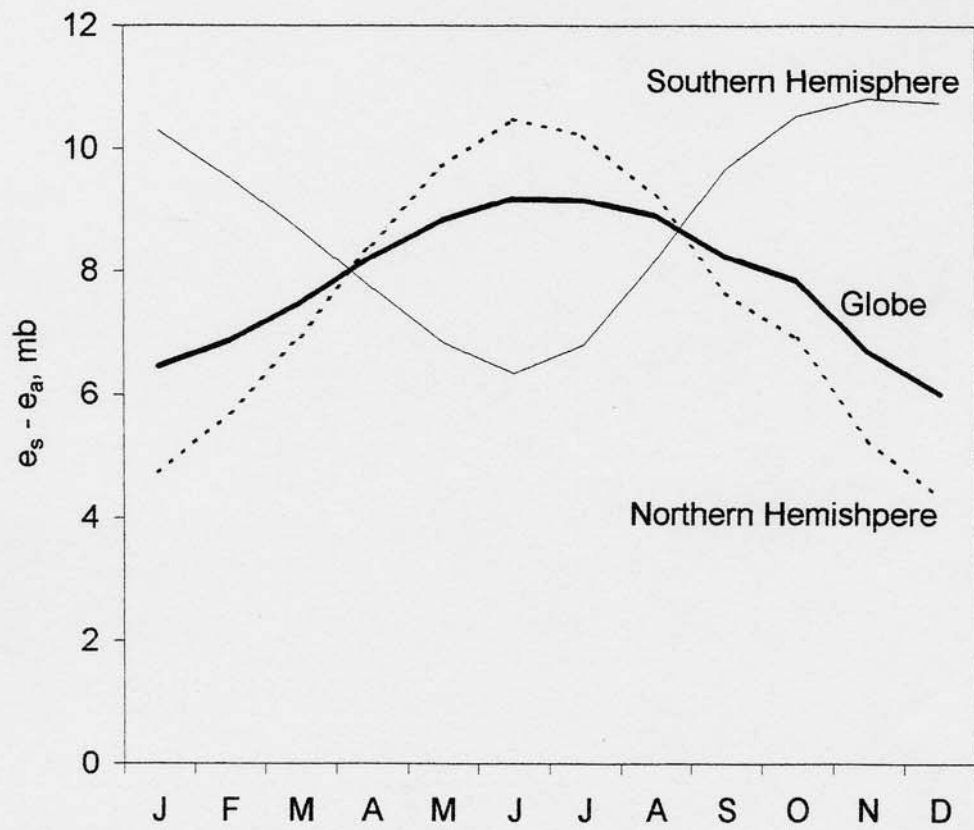

Figure C-4. Mean monthly (1961-90) water vapor saturation deficit at the surface (1000 mb) of the continents for the globe, Northern Hemisphere and Southern Hemisphere.

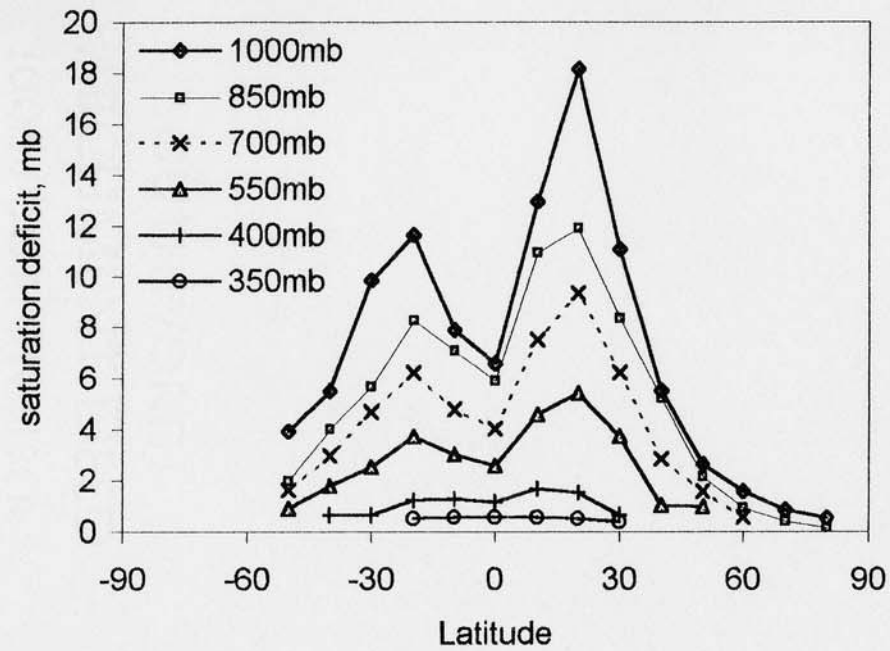

Figure C-5. Meridional profiles of the mean zonal water vapor saturation deficit at altitudes ranging from the surface (1000 mb) to 350 mb.

Table C-1. Derivation of the vertical profile of the annual vapor saturation deficit (mb) by latitude

Mid-latitude	Altitude, mb						saturation deficit (sd) for elevations (h) > 850 mb
	1000 ^a	850 ^b	700	550	400	350	
80	0.5	0.1					
70	0.8	0.4					sd = 0.003h - 2.1179
60	1.6	0.9	0.56				sd = 0.0033h - 1.8121
50	2.6	2.1	1.56	0.96			sd = 0.0038h - 1.0952
40	5.5	5.2	2.84	1.00			sd = 0.0106h - 4.5787
30	11.1	8.3	6.23	3.73	0.64	0.39	sd = 0.0167h - 5.4635
20	18.2	11.9	9.34	5.42	1.51	0.50	sd = 0.0261h - 8.9334
10	13.0	11.0	7.50	4.58	1.65	0.56	sd = 0.0195h - 6.1467
0	6.6	5.9	4.02	2.58	1.14	0.56	sd = 0.0096h - 2.7089
-10	7.9	7.1	4.78	3.03	1.27	0.56	sd = 0.0117h - 3.4164
-20	11.6	8.3	6.23	3.73	1.22	0.50	sd = 0.0167h - 5.4635
-30	9.9	5.7	4.68	2.52	0.64		sd = 0.0144h - 5.403
-40	5.5	4.0	2.96	1.78	0.64		sd = 0.0079h - 2.5734
-50	3.9	2.0	1.62	0.88			sd = 0.0063h - 2.7962

^a from global map (this dissertation)

^b based on meridional profiles of relative humidity for land (Peixoto & Oort, 1996) and temperature (Haurwitz & Austin, 1944)

The sat. def. at the highest altitude for each latitude was interpolated from zonal mean cross sections given for whole globe (i.e., ocean and land) (Peixoto & Oort, 1996)

All other sat. def. were based on regression equations (shown) developed from points at 1000 mb, 850 mb, and highest altitude for each latitude.

Table C-2. Energy (J) of the water vapor saturation deficit by latitude and altitude.

Latitude	Area, km ²	Total energy (J) at given altitude (mb)						Total
		1000 mb	850 mb	700 mb	550 mb	400 mb	350 mb	
80	1685687	6.69E+16	3.69E+16	0	0	0	0	1.04E+17
70	7817518	5.03E+17	4.63E+17	0	0	0	0	9.66E+17
60	12101767	1.44E+18	1.65E+18	1.10E+18	8.12E+15	0	0	4.20E+18
50	13786047	2.79E+18	4.40E+18	3.51E+18	2.96E+18	0	0	1.37E+19
40	12830910	5.42E+18	1.00E+19	5.93E+18	2.87E+18	0	0	2.42E+19
30	12359376	1.05E+19	1.54E+19	1.25E+19	1.03E+19	2.02E+18	5.02E+17	5.13E+19
20	11576940	1.61E+19	2.06E+19	1.76E+19	1.40E+19	4.46E+18	6.11E+17	7.34E+19
10	10022407	9.94E+18	1.64E+19	1.22E+19	1.03E+19	4.24E+18	5.92E+17	5.37E+19
0	11051876	5.57E+18	9.73E+18	7.23E+18	6.38E+18	3.22E+18	6.53E+17	3.28E+19
-10	10283746	6.21E+18	1.09E+19	8.00E+18	6.96E+18	3.34E+18	6.08E+17	3.60E+19
-20	10067917	8.96E+18	1.24E+19	1.02E+19	8.39E+18	3.14E+18	5.31E+17	4.36E+19
-30	7030558	5.30E+18	5.94E+18	5.35E+18	3.96E+18	1.15E+18	0	2.17E+19
-40	2025638	8.50E+17	1.21E+18	9.75E+17	8.04E+17	3.31E+17	0	4.17E+18
-50	731799	2.20E+17	2.15E+17	1.93E+17	1.44E+17	0	0	7.72E+17
Total		7.39E+19	1.09E+20	8.48E+19	6.71E+19	2.19E+19	3.50E+18	3.61E+20
Density, g/m ³		1.23	1.06	0.91	0.75	0.57	0.39	
Altitude, m		0	1500	3000	4750	7200	10500	

Equation:

Energy of saturation deficit at latitude Y and altitude Z, J = sat def, mb x ___ J/kg per mb x area per Y, km² x 1E6 m²/km² x density, g/m³ x mid-interval height, m

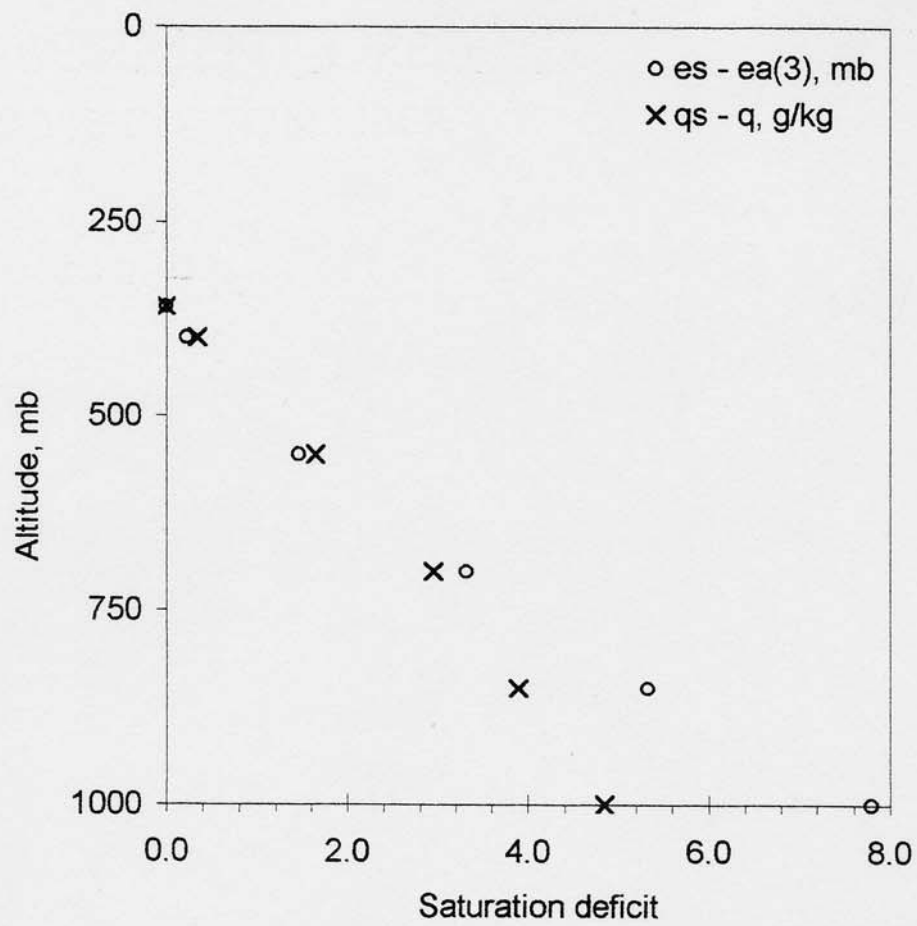

Figure C-7. Vertical profiles of water vapor saturation deficit (mb) and difference in vapor mixing ratios for the atmosphere above the continents.

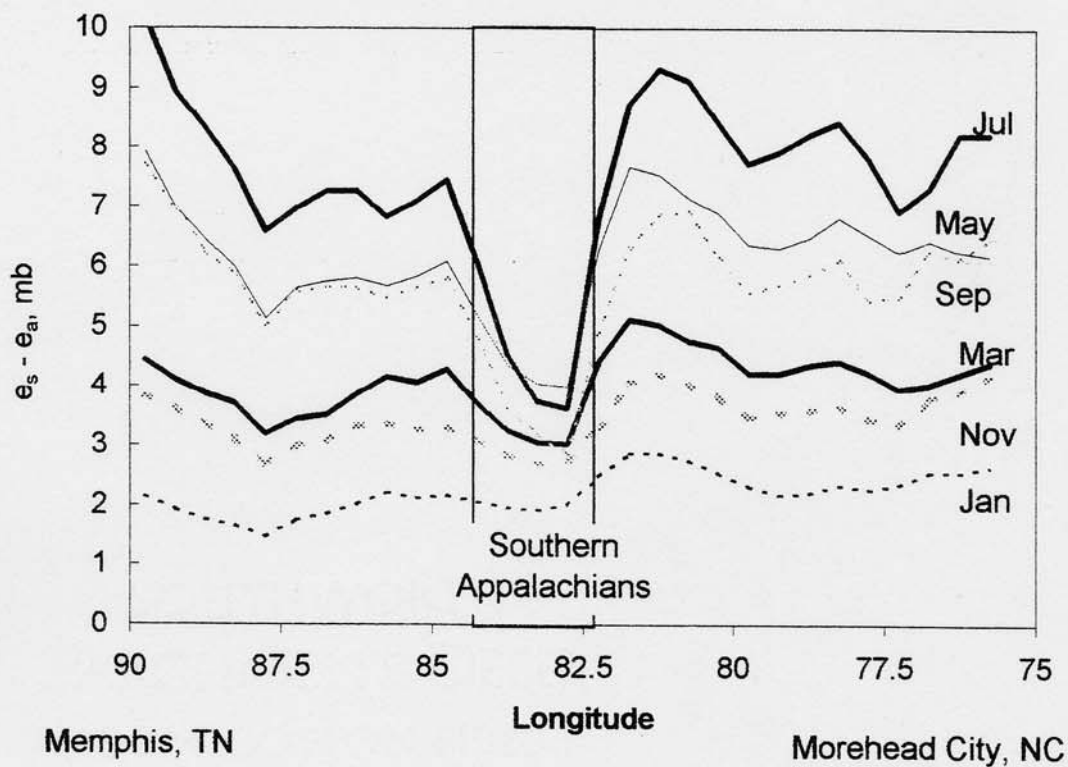

Figure C-8. Seasonal mean monthly saturation deficit across the Southern Appalachians along the 35th parallel from eastern North Carolina to western Tennessee.

Table C-3. Solar transformity of the water vapor saturation deficit overlying the continents.

Description	Value	Source
Mean annual energy of saturation deficit of atmosphere overlying the continents, J =	3.61E+20	Table C-2
Mean turnover time of atmospheric moisture, days =	8.2	UNESCO, 1978.
Annual supply of saturation deficit to atmosphere (3.61E20 J x 365 days per year / 8.2 days), J =	1.60E+22	
Global energy input to maintain saturation deficit of atmosphere, sej/y =	9.44E+24	Odum 1996
Global mean transformity of saturation deficit, sej/J =	588	

APPENDIX D CALCULATING ENERGY ABSORBED FROM WIND

A new methodology was developed and used for estimating the energy contributed from wind. First, wind speeds aloft (1000m) were approximated based on the general observation that, over land, near-surface speeds are 60% of speeds aloft (Barry and Chorley, 1992). Next, a vertical profile of wind speed was fitted to the two endpoints based on the curve-shape typically observed (Figure D-1). The total energy absorbed was found by numerically integrating the vertical change in wind velocity in a spreadsheet (explanation to follow). Only near-surface data on wind speed--typically reported at weather stations--were required, making the task of estimating energy absorption easier.

Table D-1 shows the data and equations used to calculate the wind energy absorbed in one (1) hectare of the Coweeta watershed. Columns 1-3 give the velocity profile over the 1000 m height. Wind speed increased with altitude. Column 4 gives the wind energy absorbed per unit of air between consecutive layers of the atmosphere. The last column, number 7, gives the rate of air exchange between height layers. Column 5 gives the annual wind energy absorbed between intervals of height, which was column 4 times column 7. The total wind energy absorbed over the control volume of $1\text{E}7 \text{ m}^3$ (1 ha x 1000 m) was the sum of column 5 (188 E9 J/ha/y).

Table D-1. Equations and data used to calculate annual wind energy absorbed in the Coweeta watershed.

Height above ground, m	Wind speed, mph	Wind speed, m/s	Wind energy absorbed over interval (E_h), J/m ³	Annual wind energy absorbed (E_a), J/y	Vertical profile (fractional change in speed with elevation)	Air exchange, m ³ /y
1000	7.13	3.19				
900	7.07	3.16	0.11	1.02E+09	0.0091	9.06E+09
800	6.96	3.11	0.18	2.76E+09	0.0153	1.50E+10
700	6.86	3.06	0.18	2.71E+09	0.0155	1.50E+10
550	6.71	3.00	0.25	5.16E+09	0.0221	2.09E+10
400	6.48	2.90	0.37	1.21E+10	0.0355	3.24E+10
300	6.27	2.80	0.33	9.71E+09	0.0334	2.96E+10
200	5.98	2.67	0.44	1.78E+10	0.0484	4.08E+10
100	5.30	2.37	0.94	8.91E+10	0.1273	9.52E+10
50	4.90	2.19	0.51	2.94E+10	0.0833	5.75E+10
20	4.58	2.05	0.36	1.60E+10	0.0682	4.41E+10
0.1	4.47	2.00	0.12	1.87E+09	0.0244	1.54E+10

Total wind energy absorbed (E_{total}), J/y = 187.61E+9

Total vertical air exchange, m³/y =

374.9E+9

Footnotes to Table D-1

Surface wind speed, mph =

4.47

Surface wind speed, m/s =

2.00 (CS01, Coweeta Hydro. Lab.)

Area of one hectare, m² =

1.00E+04

Annual wind speed @ surface averages 60% of that @ 1000m. (assumed)

Shape of the vertical wind profile was approximated based on Barry & Chorley 1996.

Equations:

h = height of top of interval; h' = height of bottom of interval

E_h = Energy absorbed over each height interval, J/m³

$E_h = \{[(\text{wind speed @ } h, \text{ m/s})^2 - (\text{wind speed @ } h', \text{ m/s})^2] \times (1.23 \text{ kg/m}^3 / 2)$

E_a = Energy absorbed over each height interval, J/y

$E_a = (E_h, \text{ J/m}^3) \times \{(\text{wind speed @ } h, \text{ m/s}) - (\text{wind speed @ } h', \text{ m/s})\} \times (\text{surface area, m}^2) \times (\text{seconds per time})$

E_{total} = Total energy absorbed over control volume, J/y.

E_{total} = Sum of E_a for each height interval

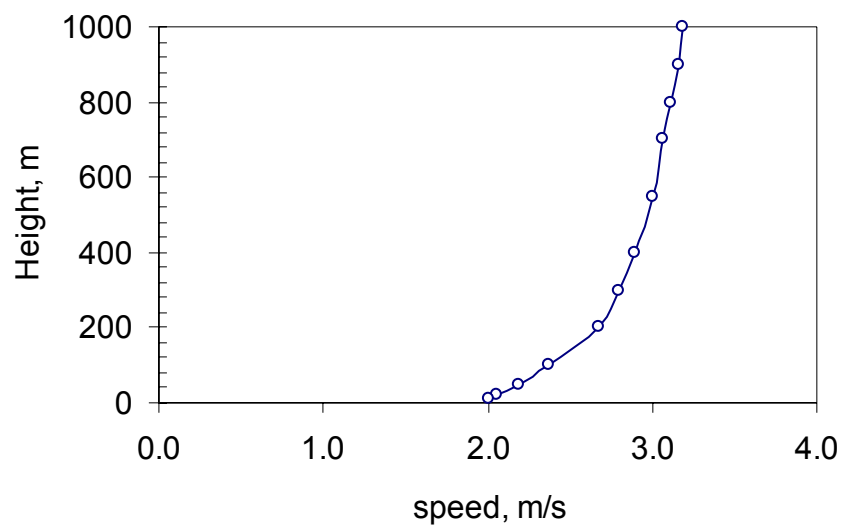

Figure D-1. Profile of wind velocity over Coweeta watershed

Table D-2. Equations and data used to calculate annual wind energy absorbed in the Wine Spring Creek watershed.

Height above ground, m	Wind speed, mph	Wind speed, m/s	Wind energy absorbed, J/m ³	Annual wind energy absorbed, J/y	Vertical profile (fractional increase in speed with elevation)	Air exchange, m ³ /y
1000	7.13	3.19				
900	7.07	3.16	0.11	1.02E+09	0.0091	9.06E+09
800	6.96	3.11	0.18	2.76E+09	0.0153	1.50E+10
700	6.86	3.06	0.18	2.71E+09	0.0155	1.50E+10
550	6.71	3.00	0.25	5.16E+09	0.0221	2.09E+10
400	6.48	2.90	0.37	1.21E+10	0.0355	3.24E+10
300	6.27	2.80	0.33	9.71E+09	0.0334	2.96E+10
200	5.98	2.67	0.44	1.78E+10	0.0484	4.08E+10
100	5.30	2.37	0.94	8.91E+10	0.1273	9.52E+10
50	4.90	2.19	0.51	2.94E+10	0.0833	5.75E+10
20	4.58	2.05	0.36	1.60E+10	0.0682	4.41E+10
0.1	4.47	2.00	0.12	1.87E+09	0.0244	1.54E+10
Total kinetic energy absorbed =				187.61E+9		
Volume of air exchanged, m ³ /y =						374.9E+9

Footnotes to Table D-2

Surface wind speed, mph = 4.47

Surface wind speed, m/s = 2.00

wind speed from climate station CS301t; 1213m; mid-elev of WSC

Area of Wine Spring Cr. basin, m² = 10000

Annual wind speed @ surface averages 60% of that @ 1000m. (assumed)

Shape of the wind profile was approximated based on Barry & Chorley 1996.

Equations:

E_a = Energy absorbed at each height interval, J/y

$$E_a = [\{ (\text{wind speed @ } h, \text{ m/s})^2 - (\text{wind speed @ } h', \text{ m/s})^2 \} \times (1.23 \text{ kg/m}^3 / 2) \times \{ (\text{wind speed @ } h, \text{ m/s}) - (\text{wind speed @ } h', \text{ m/s}) \} \times (\text{surface area, m}^2) \times (3.154 \times 10^7 \text{ s/y})]$$

E_{total} = Total energy absorbed over control volume, J/y.

E_{total} = Sum E_a over entire height

Table D-3. Equations and data used to calculate annual wind energy absorbed within a 1000 m prism overlying Macon County, N.C.

Height above ground, m	Wind energy absorbed over interval			Annual wind energy absorbed (E _a), J/y	Vertical profile (fractional change in speed with elevation)	Air exchange, m ³ /y
	Wind speed, mph	Wind speed, m/s	(E _h), J/m ³			
1000	7.17	3.21				
900	7.11	3.18	0.11	1.38E+14	0.0091	1.22E+15
800	7.00	3.13	0.19	3.75E+14	0.0153	2.02E+15
700	6.89	3.08	0.18	3.70E+14	0.0155	2.02E+15
550	6.75	3.02	0.25	7.02E+14	0.0221	2.81E+15
400	6.51	2.91	0.38	1.64E+15	0.0355	4.37E+15
300	6.30	2.82	0.33	1.32E+15	0.0334	3.98E+15
200	6.01	2.69	0.44	2.42E+15	0.0484	5.50E+15
100	5.33	2.38	0.95	1.21E+16	0.1273	1.28E+16
50	4.92	2.20	0.52	4.01E+15	0.0833	7.75E+15
20	4.61	2.06	0.37	2.18E+15	0.0682	5.94E+15
0.1	4.50	2.01	0.12	2.55E+14	0.0244	2.07E+15
Total wind energy absorbed (E _{total}), J/y				25.56E+15		50.5E+15

Footnotes to Table D-3

Surface wind speed, mph = 4.50 NOAA website
 Surface wind speed, m/s = 2.01
 Area of Macon Co., m² = 1.34E+09
 Annual wind speed @ surface averages 60% of that @ 1000m. (assumed)
 Shape of vertical wind profile was approximated based on Barry & Chorley 1996.

Equations:

h = height of top of interval; h' = height of bottom of interval

E_h = Energy absorbed over each height interval, J/m³

$E_h = [\{ (\text{wind speed @ } h, \text{ m/s})^2 - (\text{wind speed @ } h', \text{ m/s})^2 \} \times (1.23 \text{ kg/m}^3 / 2)$

E_a = Energy absorbed over each height interval, J/y

$E_a = (E_h, \text{ J/m}^3) \times \{ (\text{wind speed @ } h, \text{ m/s}) - (\text{wind speed @ } h', \text{ m/s}) \} \times (\text{surface area, m}^2) \times (\text{seconds per time})$

E_{total} = Total energy absorbed over control volume, J/y.

E_{total} = Sum of E_a for each height interval

Table D-4. Equations and data used to calculate annual wind energy absorbed within a 1000 m prism overlying North Carolina.

Height above ground, m	Wind energy absorbed over interval			Annual wind energy absorbed (E _a), J/y	Vertical profile (fractional change in speed with elevation)	Air exchange, m ³ /y
	Wind speed, mph	Wind speed, m/s	(E _h), J/m ³			
1000	9.17	4.10				
900	9.08	4.06	0.19	2.93E+16	0.0091	1.58E+17
800	8.95	4.00	0.30	7.95E+16	0.0153	2.62E+17
700	8.81	3.94	0.30	7.83E+16	0.0155	2.62E+17
550	8.62	3.85	0.41	1.49E+17	0.0221	3.65E+17
400	8.32	3.72	0.61	3.48E+17	0.0355	5.66E+17
300	8.06	3.60	0.54	2.80E+17	0.0334	5.16E+17
200	7.68	3.43	0.72	5.13E+17	0.0484	7.14E+17
100	6.82	3.05	1.55	2.57E+18	0.1273	1.66E+18
50	6.29	2.81	0.84	8.48E+17	0.0833	1.01E+18
20	5.89	2.63	0.60	4.63E+17	0.0682	7.70E+17
0.1	5.75	2.57	0.20	5.39E+16	0.0244	2.69E+17
Total wind energy absorbed (E _{total}), J/y				5.41E+18		6.6E+18

Footnotes to Table D-4

Surface wind speed was the average of stations at Asheville, Greensboro, Raleigh, Fayetteville, and Cape Hatteras taken from NOAA climate website

Surface wind speed, mph = 5.75

Surface wind speed, m/s = 2.57

Area of NC, m² = 1.36E+11

Annual wind speed @ surface averages 60% of that @ 1000m. (assumed)

Shape of the vertical wind profile was approximated based on Barry & Chorley 1996.

Equations:

h = height of top of interval; h' = height of bottom of interval

E_h = Energy absorbed over each height interval, J/m³

$E_h = [\{ (\text{wind speed @ } h, \text{ m/s})^2 - (\text{wind speed @ } h', \text{ m/s})^2 \} \times (1.23 \text{ kg/m}^3 / 2)$

E_a = Energy absorbed over each height interval, J/y

$E_a = (E_h, \text{ J/m}^3) \times \{ (\text{wind speed @ } h, \text{ m/s}) - (\text{wind speed @ } h', \text{ m/s}) \} \times (\text{surface area, m}^2) \times (\text{seconds per time})$

E_{total} = Total energy absorbed over control volume, J/y.

E_{total} = Sum of E_a for each height interval

APPENDIX E
SOLAR TRANSFORMITY OF MOUNTAIN DEEP HEAT AND EROSION

Introduction

Mountains are hierarchical centers of the landscape which require the work of all lower land for creation and maintenance (Figure E-1). Thus, the transformity of geologic processes (e.g., erosion, weathering, heat flow) and mountain structure increase with elevation. Since the mountain operates as an energy chain with higher levels having less heat flow, but the same supporting earth empower, the transformity of deep heat increased with elevation. Similarly, erosion rates increased with altitude (Chorley et al. 1984), but earth empower was assumed constant, leading to a higher ratio of empower to mass eroded with elevation. Systems theories of energy hierarchy indicate that the higher transformity of mountains results in a greater ability to effect global systems and control other more abundant forms of energy.

Here, a series of altitude dependent solar transformities were calculated for deep heat emanating from the surface of the continents and for the mass of material eroded from mountains. The new transformities and energy per mass ratios will be useful for examining the spatial configurations of empower in mountain landscapes.

Methods

Deep heat

The transformity of deep heat flow at varying altitudes was calculated by dividing the total heat flow at elevation into the total empower supporting the world's geobiospheric processes ($9.44 \text{ E}24 \text{ sej y}^{-1}$). The total heat flow at an elevation was found by multiplying the deep heat flux per area by the area of the globe above the given elevation. The area above an elevation was determined from the earth's hypsographic curve. A world hypsographic curve was interpolated from a graph in Duxbury and Duxbury (1991). The elevation gradient of deep heat flux was derived from the global heat flow database compiled by Pollack et al. (1991).

The change in deep heat flux per change in elevation was found by pooling the 7200+ data points of the global heat flow database (Pollack et al. 1991) into 500 m intervals from 0 to 4000 m. Pooling was necessary since the number of measurements at lower elevations drastically outnumbered the high elevation measurements. The arithmetic average of the observations made within each 500 m interval were plotted against the mid-elevation to develop a graph of deep heat flow as a function of altitude.

Mountain Erosion

The energy per mass of mountain erosion was calculated for various altitudes by dividing the total empower supporting the world's geobiospheric processes ($9.44 \text{ E}24 \text{ sej y}^{-1}$) by the total erosion above a given elevation (see Table E-2).). The total mountain erosion above an elevation was found by multiplying the erosion rate (mass/area/time) by

the area of the globe above the given elevation. The same area-elevation relationship was used for mountain erosion, as used for deep heat (see explanation in previous section).

Results

Deep heat

The deep heat generated per unit area was found to increase 26.5 mW m^{-2} per km of elevation (Figure E-2). Elevation explained the majority (64%) of the variation in heat flow.

The transformity of deep heat flow near sea level was 2.9 E4 sej/J , while at elevations of 1000 m it was twice that amount, 5.9 E4 sej/J (Table E-1). The highest peaks on earth ($> 8000 \text{ m}$) had transformities on the order of 3 E7 sej/J . By comparison, Odum (1996) estimated that the mean transformity for continental deep heat was 3.4 E4 sej/J . The mean empower density of deep heat also increased with elevation (Table E-1).

Mountain Erosion

The emergy per mass of mountain erosion increased with altitude at an exponential rate (Figure E-3). For example, at an altitude of 1000 m, mountain erosion had a emergy per mass ratio of 1.9 E9 sej/g (Table E-2), while at 4000 m, the ratio was 14.2 E9 sej/g .

The mean elevation of the Wine Spring Creek (WSC) watershed (1320m) was above the global mean (840m). The altitude-dependent solar transformity of deep heat at the mean elevation of WSC was 7.5 E4 sej/J , double the 3.4 E4 sej/J used in the emergy

evaluations. The empower density of the geologic work, calculated with the altitude-dependent transformity, was $1020 \text{ E}12 \text{ sej/ha/y}$. This was double the empower density estimated with the mean global transformity of land deep heat.

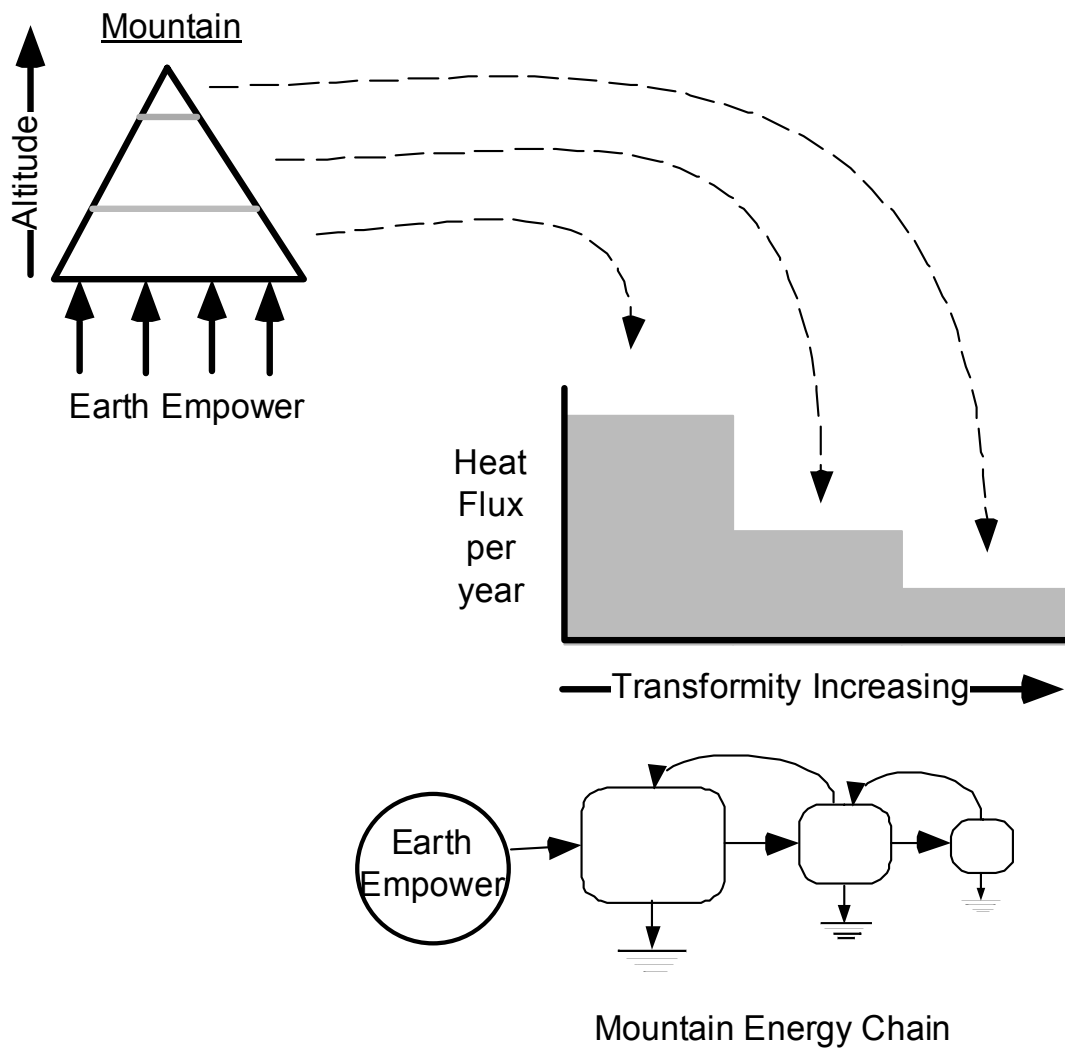

Figure E-1. Diagram illustrating how total heat flow of the earth decreased with altitude. (Heat release per unit area increased slightly with altitude, see Figure E-2). The same solar empower was supporting heat flux at each level, thus the transformity of heat release increased with altitude.

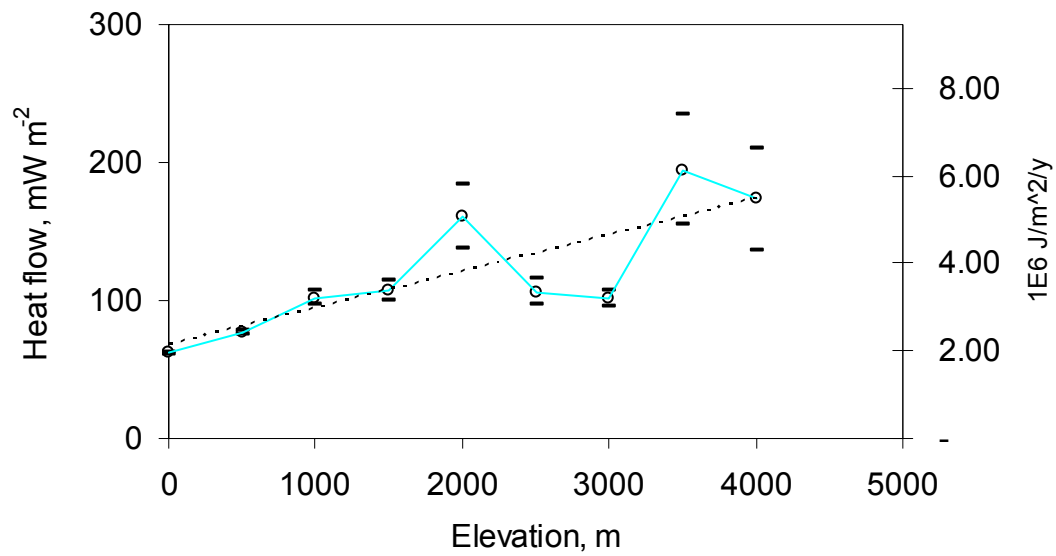

Figure E-2. Mean (+/- SEM; variable n) flow of deep heat versus elevation averaged over the globe. Heat flow, $\text{mW m}^{-2} = 67.4 + 0.0265 \cdot \text{elevation (m)}$.

Table E-1. Solar transformity and empower density of deep heat as a function of altitude.

Elev, m	Area above given elevation, $1 \times 10^9 \text{ m}^2$	Heat flow, mW/m ²	Total heat flow, 1×10^{12} mW	Transformity of deep heat at given elevation, sej/J	Empower density, 1×10^{12} sej/ha/y
	A	B	C	D	E
0	149,984	69	10,349	28,924	629
100	135,049	72	9,676	30,936	699
500	88,733	82	7,298	41,015	1,064
1000	52,491	96	5,013	59,715	1,799
1500	31,051	109	3,377	88,646	3,041
2000	18,368	122	2,241	133,577	5,140
3000	6,428	149	955	313,599	14,688
4000	2,249	175	394	760,454	41,973
5000	787	202	159	1,887,318	119,945
6000	275	228	63	4,766,444	342,761
7000	96	255	25	12,202,555	979,491
8000	34	281	9	31,582,133	2,799,042

Footnotes to Table E-1

A -- Hypsographic curve of world estimated from figure given in Duxbury & Duxbury (1991).

B -- Deep heat at elevation = $69 + (0.00265 \times \text{height, m})$ (see Figure E-2)

C -- Total heat flow = Area x heat flow per area

D -- Transformity of deep heat at given elevation = (Global emergy input, 9.44×10^{24} sej/y) / (total heat flow, J/y)

E -- Empower at given elevation = (Transformity, sej/J) x (heat flow, J/ha/y)
Empower density = $629 \exp(0.00105H)$; H is height in meters.

Table E-2. Solar energy per gram of mountain erosion as a function of altitude.

Elev, m	Area above given elevation, $1 \times 10^9 \text{ m}^2$	Denudation rate, cm/1000 y	Total erosion, $1 \times 10^{15} \text{ g}$	Energy per gram above given elevation, $1 \times 10^9 \text{ sej/g}$
	A	B	C	D
0	149,984	1.1	4.3	2.2
1000	52,491	3.7	5.0	1.9
2000	18,368	6.2	3.0	3.2
3000	6,428	8.8	1.5	6.4
4000	2,249	11.3	0.7	14.2
5000	787	13.9	0.3	33.2
6000	275	16.4	0.1	80.1
7000	96	19.0	0.0	198.2
8000	34			

Footnotes to Table E-2

A -- Hypsographic curve of world estimated from figure given in Duxbury & Duxbury (1991).

B -- Denudation rate = $(0.0001535 \text{ (mid-altitude)} + 0.01088)/6$. The equation, taken from Ahnert cited in Chorley et al. (1984) was divided by six (6) so that the total erosion of the earth would equal $9.5 \text{ E}15 \text{ g/y}$, the total earth cycle.

C -- Total erosion = $(\text{area, m}^2) \times (\text{denudation rate, cm/1000 y}) / (1000 \text{ y}) \times (2.6 \text{ E}6 \text{ g/m}^3) \times (1 \text{ m/100cm})$

D -- Solar energy per gram above given elevation = $(\text{Global energy input, } 9.44 \times 10^{24} \text{ sej/y}) / (\text{total erosion above given elevation, g/y})$

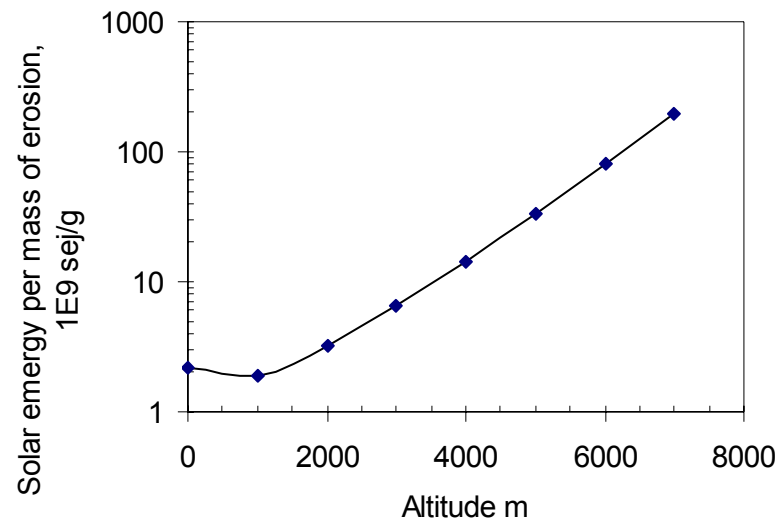

Figure E-3. Solar energy per gram of mountain erosion as a function of altitude. See Table E-2 for calculations. Solar energy per mass (sej/g) = $[0.694\exp(7.875 \text{ E}4)*A]*1\text{E}9$; where A is altitude in meters, exp is base of natural logarithm.

APPENDIX F
PROGRAM CODE FOR EXTEND BLOCKS
USED IN SIMULATION MODELS

This appendix contains the programming code for the Extend blocks (graphical user interface icons) used to simulate the models developed in this dissertation.

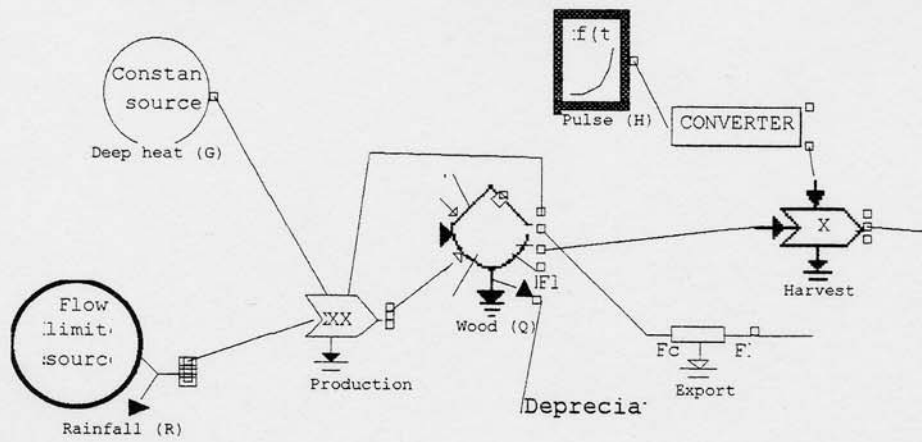

Figure F-1. Extend representation of model EMERGYDYN used for simulating the emergy and transformity of wood biomass for the Cow watershed (compare to systems diagram in Figure 3-7).

```

Constant Code is 0;  ** Array definition
Constant Force is 1;
Constant Flow is 2;
Constant Transformity is 3;

Real Q, dQ, EM, dEM, km, kd,  ** Variables for storage
  Inflow1, Inflow2, Inflow3, Inflow4, Inflow5,
  ST1, ST2, ST3, ST4, ST5, ** Variables for inflow
  Outflow1, Outflow2, Outflow3, Outflow4, ST,ST4o,  ** Variables for outflow
  Matteroutflow, STm,EC;

Real  Con1inarray[], Con2inarray[], Con3inarray[], Con4inarray[], Con5inarray[],
  Received1inarray[], Received2inarray[], Received3inarray[], Received4inarray[],
Received5inarray[],
  Con1outarray[], Con2outarray[], Con3outarray[], Con4Outarray[],
  Received1outarray[], Received2outarray[],
Received3outarray[],Received4outarray[],Received5outarray[],
  Matteroutarray[], Sensoroutarray[];

** Set initial values for the dialog
on Createblock
{
  Fract = 0.01;
  Calibstore = 100;
  Calibdrain = 5;
  Initstore = 1;
  Inittransformity = 10000;
  Materialfraction = .01;
  emergyconserv = 0;
}

** Initialize any simulation variables.
on Initsim
{
  Q = Initstore;
  ST = Inittransformity;
  kd = Calibdrain / Calibstore;
  km = Materialfraction * kd;
  EM = ST * Q;

  Makearray(Con1inarray, 4);
  Con1inarray[Code] = -1;
  Con1inarray[Force] = 0.0;
  Con1inarray[Flow] = 0.0;
  Con1inarray[Transformity] = 0.0;

  Makearray(Con2inarray, 4);
  Con2inarray[Code] = -1;
  Con2inarray[Force] = 0.0;
  Con2inarray[Flow] = 0.0;
  Con2inarray[Transformity] = 0.0;

  Makearray(Con3inarray, 4);
  Con3inarray[Code] = -1;
  Con3inarray[Force] = 0.0;
  Con3inarray[Flow] = 0.0;

```

```

Con3inarray[Transformity] = 0.0;

Makearray(Con4inarray, 4);
Con4inarray[Code] = -1;
Con4inarray[Force] = 0.0;
Con4inarray[Flow] = 0.0;
Con4inarray[Transformity] = 0.0;

Makearray(Con5inarray, 4);
Con5inarray[Code] = -1;
Con5inarray[Force] = 0.0;
Con5inarray[Flow] = 0.0;
Con5inarray[Transformity] = 0.0;

Makearray(Con1outarray, 4);
Con1outarray[Code] = -1;
Con1outarray[Force] = 0.0;
Con1outarray[Flow] = 0.0;
Con1outarray[Transformity] = 0.0;

Makearray(Con2outarray, 4);
Con2outarray[Code] = -1;
Con2outarray[Force] = 0.0;
Con2outarray[Flow] = 0.0;
Con2outarray[Transformity] = 0.0;

Makearray(Con3outarray, 4);
Con3outarray[Code] = -1;
Con3outarray[Force] = 0.0;
Con3outarray[Flow] = 0.0;
Con3outarray[Transformity] = 0.0;

Makearray(Con4outarray, 4);
Con4outarray[Code] = -1;
Con4outarray[Force] = 0.0;
Con4outarray[Flow] = 0.0;
Con4outarray[Transformity] = 0.0;

Makearray(Matteroutarray, 4);
Matteroutarray[Code] = -1;
Matteroutarray[Force] = 0.0;
Matteroutarray[Flow] = 0.0;
Matteroutarray[Transformity] = 0.0;

Makearray(Sensoroutarray, 4);
Sensoroutarray[Code] = -1;
Sensoroutarray[Force] = 0.0;
Sensoroutarray[Flow] = 0.0;
Sensoroutarray[Transformity] = 0.0;
}

** Start simulation
on Simulate
{
  If (Getpassedarray(Con1in, Received1inarray))
  {

```

```

Con1inarray[Code] = Received1inarray[Code];
Con1inarray[Flow] = Received1inarray[Flow];
Con1inarray[Transformity] = Received1inarray[Transformity];
}

If (Con1inarray[Code] == 1)
    Opndialogbox(); ** Code 1 is force, but should be Code 2 for flow

If (Getpassedarray(Con2in, Received2inarray))
{
    Con2inarray[Code] = Received2inarray[Code];
    Con2inarray[Flow] = Received2inarray[Flow];
    Con2inarray[Transformity] = Received2inarray[Transformity];
}

If (Con2inarray[Code] == 1)
    Opndialogbox(); ** code 1 is force but should be code 2 for flow

If (Getpassedarray(Con3in, Received3inarray))
{
    Con3inarray[Code] = Received3inarray[Code];
    Con3inarray[Flow] = Received3inarray[Flow];
    Con3inarray[Transformity] = Received3inarray[Transformity];
}

If (Con3inarray[Code] == 1)
    Opndialogbox(); ** code 1 is force but should be code 2 for flow

If (Getpassedarray(Con4in, Received4inarray))
{
    Con4inarray[Code] = Received4inarray[Code];
    Con4inarray[Flow] = Received4inarray[Flow];
    Con4inarray[Transformity] = Received4inarray[Transformity];
}

If (Con4inarray[Code] == 1)
    Opndialogbox(); ** code 1 is force but should be code 2 for flow

If (Getpassedarray(Con5in, Received5inarray))
{
    Con5inarray[Code] = Received5inarray[Code];
    Con5inarray[Flow] = Received5inarray[Flow];
    Con5inarray[Transformity] = Received5inarray[Transformity];
}

If (Con5inarray[Code] == 1)
    Opndialogbox(); ** code 1 is force but should be code 2 for flow

If (Getpassedarray(Con1out, Received1outarray))
    Con1outarray[Flow] = Received1outarray[Flow];

If (Getpassedarray(Con2out, Received2outarray))
    Con2outarray[Flow] = Received2outarray[Flow];

If (Getpassedarray(Con3out, Received3outarray))

```

```

**Con3outarray[Code] = Received3outarray[Code];
Con3outarray[Flow] = Received3outarray[Flow];
**Con3outarray[Transformity] = Received3outarray[Transformity];

If (Getpassedarray(Con4out, Received4outarray))
{
    Con4outarray[Flow] = Received4outarray[Flow];
    Con4outarray[Transformity] = Received4outarray[Transformity];
}
If (Getpassedarray(Matterout, Received5outarray))
{
    Matteroutarray[Flow] = Received5outarray[Flow];
}

If (Currentstep == 0)
{
    Con1inarray[Force] = Q;
    Con2inarray[Force] = Q;
    Con3inarray[Force] = Q;
    Con4inarray[Force] = Q;
    Con5inarray[Force] = Q;

    Con1outarray[Code] = 1; ** Code 1 is force out
    Con1outarray[Force] = Q;
    Con1outarray[Transformity] = ST;

    Con2outarray[Code] = 1; ** Code 1 is force out
    Con2outarray[Force] = Q;
    Con2outarray[Transformity] = ST;

    Con3outarray[Code] = 1; ** Code 1 is force out
    Con3outarray[Force] = Q;
    Con3outarray[Transformity] = ST;

    Con4outarray[Code] = 1; ** Code 1 is force out
    Con4outarray[Force] = Q;
    Con4outarray[Transformity] = ST;

    Matteroutarray[Code] = 1; ** Code 2 for flow out
    Matteroutarray[Force] = Q;
    Matteroutarray[Transformity] = 0.0;

    Sensoroutarray[Code] = 1;
    Sensoroutarray[Force] = Q;
    Sensoroutarray[Transformity] = ST;
}

Else
{
    Inflow1 = Con1inarray[Flow];
    Inflow2 = Con2inarray[Flow];
    Inflow3 = Con3inarray[Flow];
    Inflow4 = Con4inarray[Flow];
    Inflow5 = Con5inarray[Flow];

    Outflow1 = Q*Con1outarray[Flow];

```

```

Outflow2 = Q*Con2outarray[Flow];
Outflow3 = Q*Con3outarray[Flow];
Outflow4 = Q*Con4outarray[Flow];
Matteroutflow = kd*Q; **Matteroutarray[flow];

STm = EM / (Materialfraction * Q);

dQ = Inflow1 + Inflow2 + Inflow3 + Inflow4 + Inflow5 - kd * Q - Outflow1 - Outflow2 - Outflow3 -
Outflow4;**- Matteroutflow;
Q = Q + dQ * DeltaTime;

If (Q <= 0)
{
  Q = 0;
}

ST1 = Con1inarray[Transformity];
ST2 = Con2inarray[Transformity];
ST3 = Con3inarray[Transformity];
ST4 = Con4inarray[Transformity];
ST5 = Con5inarray[Transformity];
ST4o =Con4outarray[Transformity];

If (Outflow4 > 0.0)
{
  ST4o = ST;
}
If(emergyconserv)
{
  EC=1;
}
If ( (dQ > 0) AND (dQ/Q > fract))
  dEM = ST1*Inflow1 + ST2*Inflow2 + ST3*Inflow3 + ST4*Inflow4 + ST5*Inflow5 - ST*Outflow1 -
ST*Outflow2 - ST*Outflow3 - EC*ST * Outflow4;
  ** ST*matteroutflow;
else if (dQ == 0)
  dEM = 0;
else if ((dQ > 0) AND (dQ/Q < fract) )
  dEM =0;
else      ** if dQ is negative
  dEM = ST * dQ;

EM = EM + dEM * Deltatime;

If (EM <= 0)
  EM = 0.1;

ST = EM / Q;
  EC=0;
Con1inarray[Force] = Q;
Con2inarray[Force] = Q;
Con3inarray[Force] = Q;
Con4inarray[Force] = Q;
Con5inarray[Force] = Q;

Con1outarray[Code] = 1; ** Code 1 is force out

```

```

Con1outarray[Force] = Q;
Con1outarray[Flow] = outflow1;
Con1outarray[Transformity] = ST;

Con2outarray[Code] = 1; ** Code 1 is force out
Con2outarray[Force] = Q;
Con2outarray[Transformity] = ST;

Con3outarray[Code] = 1; ** Code 1 is force out
Con3outarray[Force] = Q;
Con3outarray[Transformity] = ST;

Con4outarray[Code] = 1; ** Code 1 is force out
Con4outarray[Force] = Q;
Con4outarray[Transformity] = ST;

Matteroutarray[Code] = 1; ** Code 1 for force out
Matteroutarray[Flow] = Matteroutflow;
Matteroutarray[Force] = Q;
Matteroutarray[Transformity] = ST; ** DRT changed from STm on 8/23/95

Sensoroutarray[Code] = 1;
Sensoroutarray[Force] = Q;
Sensoroutarray[Transformity] = ST;
}

Con1in = Passarray(Con1inarray);
Con2in = Passarray(Con2inarray);
Con3in = Passarray(Con3inarray);
Con4in = Passarray(Con4inarray);
Con5in = Passarray(Con5inarray);

Con1out = Passarray(Con1outarray);
Con2out = Passarray(Con2outarray);
Con3out = Passarray(Con3outarray);
Con4out = Passarray(Con4outarray);

Matterout = Passarray(Matteroutarray);
Sensorout = Passarray(Sensoroutarray);
}

** If the dialog data is inconsistent for simulation, abort.
on Checkdata
{
  If (Novalue(Initstore))
    abort;
}

** User clicked the dialog HELP button.
on Help
{
  showHelp();
}

```

APPENDIX G

MISCELLANEOUS DATA TABLES AND EMERGY EVALUATIONS

This appendix contains data tables and miscellaneous emergy evaluation tables.

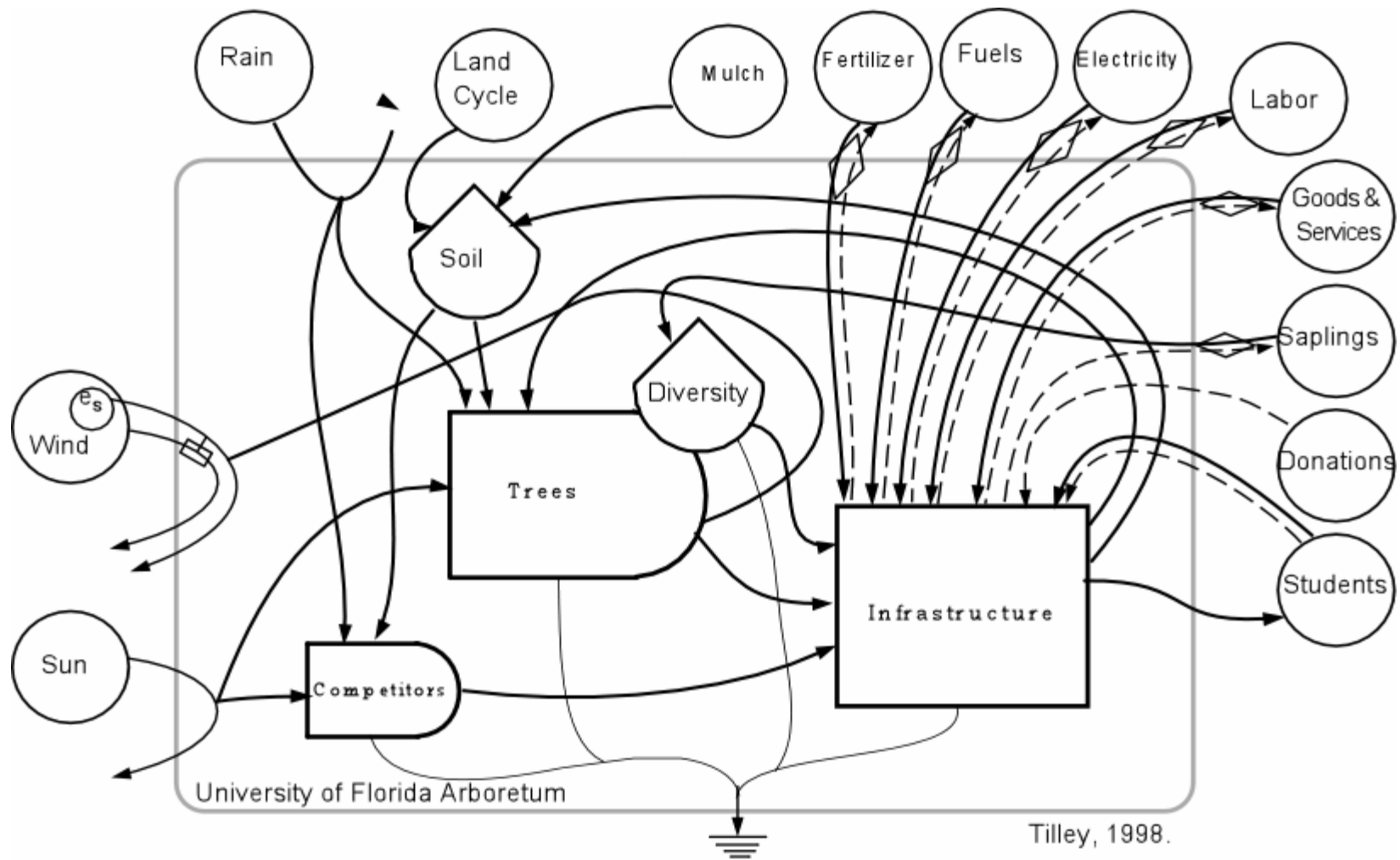

Figure G-1. Systems diagram of the environmental--economic interface of the UF Arboretum, Gainesville, Florida.

Table G-1. Emery evaluation of the University of Florida Arboretum (2 ha; ca.1993)

Note	Item	Raw Units	Trans- formity (sej/unit)	Solar Emergy 1 E14 sej/y	Macroeconomic Value (1990 US\$)
1	Sunlight	9.15E+13 J	1	0.9	61
2	Rain Transpired	7.56E+10 J	18,200	13.8	917
3	Soil formation (erosion)	3.66E+10 J	34400	12.6	839
4	Water from irrigation	2.99E+09 J	160,000	4.8	319
5	Mulch	4.27E+10 J	17,200	7.3	489
6	Fuel for mowing	3.09E+10 J	66,000	20.4	1,361
7	Fertilizer				
	Nitrogen	5832 g	3.45E+09	0.2	13
	Phosphorus	2592 g	3.90E+09	0.1	7
	Potassium	3240 g	2.96E+09	0.1	6
8	Fertilizer, \$ pd.	107 \$	1.50E+12	1.6	107
9	Electricity for irrigation	2.79E+09 J	160,000	4.5	298
10	Electricity, \$ pd.	120 \$	1.50E+12	1.8	120
11	Herbicide, \$ pd.	140 \$	1.50E+12	2.1	140
12	Start-up costs	600 \$	1.50E+12	9.0	600
13	Labels for trees	32 \$	1.50E+12	0.5	32
14	Human service				
	Pruning	1600 \$	1.50E+12	24.0	1,600
	Planting, irrigation, star	900 \$	1.50E+12	13.5	900
	Administration	13000 \$	1.50E+12	195.0	13,000
	Mowing	975 \$	1.50E+12	14.6	975
	Sum of all items except 1			326	21,724

Footnotes to Table G-1 (UF Arboretum)

1 SOLAR ENERGY

$$\begin{aligned}
 \text{Area of tree unit, ha} &= 2.0\text{E}+0 \\
 \text{Insolation @ ground} &= 6.1\text{E}+9 \text{ J/m}^2/\text{yr} \\
 \text{Area planted, \%} &= 75\% \text{ estimated} \\
 \text{Energy(J)} &= (\text{area}) * (\text{avg insolation}) \\
 &= (\text{ } \text{m}^2) * (\text{ } \text{J/m}^2/\text{y}) \\
 &= 91.5\text{E}+12
 \end{aligned}$$

Transformity, defined as 1.

2 Rain Transpired

$$\begin{aligned}
 \text{Rainfall, m/y} &= 1.36 \quad \text{mean for North central Florida} \\
 \% \text{ as transpiration} &= 0.75 \quad \text{estimated} \\
 \text{Rain chemical energy used by trees (J)} &= (\text{area})(\text{transpiration rate})(\text{Gibbs no.}) \\
 &= (\text{ } \text{m}^2) * (\text{ } \text{m}) * (1000 \text{ kg/m}^3) * (4940 \text{ J/kg})
 \end{aligned}$$

= 7.56E+10
 Transformity of average global rainfall (Odum, 1996)

3 Soil formation (erosion)

Use the average empower density of land throughout the globe (629 E12 sej/ha/y).

Use transformity of deep heat to calculated energy flow.

4 Water from irrigation

According to Dr. Dehgan:

Trees are irrigated twice a week in summer (6 months) at a rate of 7.5 gallons per tree.

Water used, J/y = (2/wk)x(26wk/y)x(7.5gal/tree)x(3.79 L/gal)x(1000g/L)x(5J/g)x(405 trees)

Water used, J/y = 2.99E+09

Transformity of municipal water supplied by Gainesville Regional Utilities (A. Buenfil, dissertation forthcoming)

5 Mulch

According to Dr. Dehgan:

Mulch is applied at the base of the trees at a rate of 20 cu. Yd. Per year for whole unit.

Mulch used, J/y =

= (20 yd³/y)x(9 ft³/yd³)x(0.0283 m³/ft³)x(0.5E6 g/m³)x(4 kcal/g)x(4186J/kcal)

Mulch used, J/y = 4.27E+10

Transformity is that calculated for Coweeta (this study).

6 Fuel for mowing

According to Dr. Dehgan:

Tree unit is cut once weekly in summer, once per two weeks in winter

Gasoline usage rate, gal/h = 2

Mowing rate, ac/h = 2

Energy used to cut grass, J/y =

= (2 ha)x(39 #/yr)x(0.5 hr/ac)x(2.5 ac/ha)x(2 gal/hr)x(3790 g/gal)x(10 kcal/g)x(4186 kcal)

Energy used to cut grass, J/y = 3.0937E+10

Transformity is average for petroleum products (Odum, 1996)

7 Fertilizer

According to Dr. Dehgan:

Each tree receives 80 grams of 18-8-10 slow release (\$75 per 50 lb. Bag)

Therefore, total fertilizer used equals (80 g/y/tree)x(405 trees), g/y = 32,400

Nitrogen

18% of total as N, g/y = 5832

Phosphorus

8% of total as P, g/y = 2592

Potassium

10% of total as K, g/y = 3240

Emergy per gram from Odum, 1996.

8 \$ paid for fertilizer

$$\begin{aligned} & (\text{fertilizer used per year}) \times (\$75 \text{ per } 50 \text{ lb bag}) \\ \$ \text{ pd} &= (32,400 \text{ g/y}) \times (0.0022 \text{ lb/g}) \times (\$75/50\text{lb-bag}) \\ \$ \text{ pd per year} &= \qquad \qquad \qquad \$107 \end{aligned}$$

9 Electricity for irrigation

According to Dr. Dehgan:

A 5 hp pump is used 2 days per week in summer (6 months) for 4 hrs each day used.

$$\begin{aligned} \text{Electrical energy used, J/y} &= \\ &= (5 \text{ hp}) \times (1 \text{ kW}/1.341\text{hp}) \times (1000 \text{ W/kW}) \times (1\text{J/s/W}) \times (52 \text{ #/y}) \times (4 \text{ h/\#}) \times (3600 \text{ s/h}) \end{aligned}$$

$$\text{Electrical energy used, J/y} = \qquad \qquad \qquad 2.79\text{E}+09$$

Transformity is mean for coal-fired power plants (Odum, 1996)

10 Electricity, \$ pd.

According to Dr. Dehgan: \$10/month

$$(\$10/\text{month}) \times (12 \text{ months/y}) = \qquad \qquad \qquad \$120$$

11 Herbicide, \$ pd.

According to Dr. Dehgan: one gallon of Round-up (\$140/gal) is used per year.

$$\begin{aligned} \$ \text{ paid for herbicide per y} &= (\$140/\text{gal}) \times (1 \text{ gal/y}) \\ & \qquad \qquad \qquad \$140 \end{aligned}$$

12 Start-up costs

According to Dr. Dehgan:

A \$20,000 grant was used to buy saplings and install irrigation.

\$10,000 worth of trees were donated.

Assume project life of 50 yrs.

$$\text{Ammortized cost for start-up} = (\$30,000/50\text{y}) = \qquad \qquad \qquad \$600$$

13 Labels for trees

According to Dr. Dehgan:

One label per species was bought (\$12 ea) and attached

Assume project life of 50 yrs.

$$(\$12/\text{label}) \times (1 \text{ label/species}) \times (135 \text{ species}) / (50 \text{ y}) = \qquad \qquad \qquad \$32$$

14 Total labor*Pruning*

Requires 2 days per year to prune crop. Dr. Dehgan and Dr. Black perform pruning

Dollar rate, \$/h = \qquad \qquad \qquad 50 \qquad \text{estimated}

Labor for pruning, \$/y = (2 people) \times (2 d/y) \times (8 h/d) \times (\\$50/h)

$$\text{Labor for pruning, } \$/y \qquad \qquad \qquad \$1,600$$

Planting, install irrigation, start-up maintenance

Half-time employee for first three years

Dollar rate, \$/h = 15 estimated
 Ammortize over 50 y life of project
 Labor required, \$/y = (1 person)x(1000 h/y)x(\$15/h)x(3 y)/(50y)
 Labor required, \$/y = \$900

Administration

Dr. Dehgan devotes 5 h/wk to overseeing operation.
 Dollar rate, \$/h = 50 estimated
 Labor required, \$/y = (1 person)x(5 h/wk)x(52 wk/y)x(\$50/h)
 Labor required, \$/y = \$13,000

Mowing

see fuels for mowing above.
 Labor required, \$/y = (2 ha)x(39 #/y)x(0.5 h/ac)x(2.5 ac/ha)x(\$10/h)
 Labor required, \$/y = \$975

Data was supplied by Professor Bijan Dehgan, creator and administrator of the UF Tree Unit.

Tree unit was established in 1993.

It is located on SW 23 St., Gainesville, FL

There are 135 North Central Florida trees on 2 ha.

Table G-2. Evaluation of the energy, water, and sediment budgets of the continents.

Continent	Area, 1000 km ² (1)	Water runoff, km ³ /y (2)	Discharge of suspended sediment, 1E6 MT/y (3)	Precipitation, km ³ /y (4)	Precipitation empower, 1E24 sej/y (5)	Empower per suspended sediment, 1E9 sej/g (6)	Suspended sediment per water runoff, g/m ³ (7)
Europe	9800	2850	439	7540	0.68	1.55	154
Asia	40775	13560	10500	25700	2.31	0.22	774
Africa	29530	4110	988	21400	1.93	1.95	240
N. America	20060	7840	1100	16200	1.46	1.33	140
S. America	17800	11700	2440	28400	2.56	1.05	209
Australia	7615	2370	197	3470	0.31	1.59	83
All continents	125580	42430	15664	102710	9.24	0.59	369

Footnotes to Table G-2

(1), (2), (3), & (4) from UNESCO, 1978.

(5) Empower of precipitation, sej/y = (precipitation, km³/y) × (1E15g/km³) × (9E4 sej/g)

(6) Empower per sediment, sej/g = (empower of precipitation, sej/y) / (sediment discharge, g/y)

(7) Suspended sediment per water runoff, sej/g = (sediment discharge, g/y) / (water runoff, m³/y)

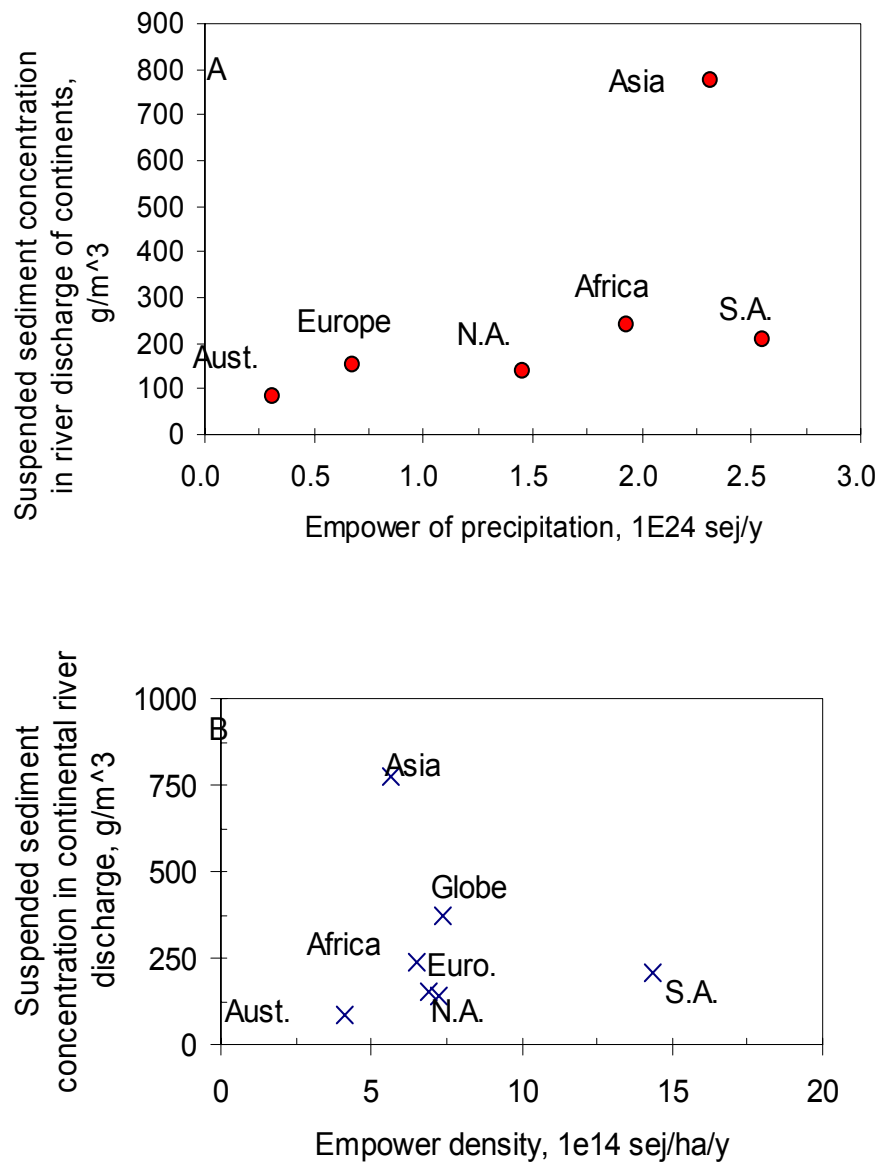

Figure G-2. Concentration of suspended sediment in continental river discharge as a function of (a) total empower of continental precipitation and (b) empower density of continental

Table G-3. Sediment and energy budgets for the main river basins of N.C. based on historic, agriculture, and present day sediment

Basin name	Area, ha	Historic (Forested) Sediment Export Rate ^a	Mean Yield of Sediment from Agriculture basins ^a	Mean Sediment Export Rate from Basin ^a	Historic (Forested) Sediment Export	Yield of Sediment if 100% Agriculture Landuse	Actual Sediment Exported from Basin	Historic sediment exported	Sediment exported if Agriculture 100%	Actual Sediment exported
		g m ⁻² y ⁻¹			1000 MT y ⁻¹		Million EM\$ per year			
Cape Fear	2,430,056	8.6	63.0	21.0	209	1,531	510	139	1,021	340
Chowan	344,792	1.8	4.0	4.0	6	14	14	4	9	9
Chowan	264,425	1.8	4.0	15.0	5	11	40	3	7	26
French Broad	746,009	15.4	56.0	67.0	115	418	500	77	279	333
Hiawassee	127,152	15.4	38.0	24.0	20	48	31	13	32	20
Little Tennessee	434,487	15.4	56.0	175.0	67	243	760	45	162	507
Lumber	841,069	1.8	4.0	4.0	15	34	34	10	22	22
Neuse	1,375,677	8.6	42.0	11.0	118	578	151	79	385	101
New	304,440	1.8	4.0	4.2	5	12	13	4	8	9
Pasquatank	277,682	1.8	4.0	15.0	5	11	42	3	7	28
Roanoke	900,900	8.6	88.0	4.2	77	793	38	52	529	25
Savannah	49,503	15.4	67.0	66.7	8	33	33	5	22	22
Tar-Pamlico	1,096,543	8.6	40.0	15.0	94	439	164	63	292	110
Upper Broad	386,882	15.4	98.0	137.0	60	379	530	40	253	353
Upper Catawba	871,534	15.4	98.0	133.0	135	854	1,159	90	569	773
Upper New	203,068	15.4	49.0	130.0	31	100	264	21	66	176
Watuaga	40,283	15.4	49.0	49.0	6	20	20	4	13	13
Yadkin--Pee Dee	1,901,906	15.4	105.0	19.0	294	1,997	361	196	1,331	241
Total	12,596,408	10.1	59.6	37.0	1270	7513	4663	847	5,009	3,109

^a -- Sediment yield rates based on Simmons, 1993.

4.66E+21

Table G-4. Emergy evaluation of North Carolina leaf tobacco, 1987.

Note	Item	Raw Units	Trans- formity (sej/unit)	Solar Emergy (E20 sej)	Emdollar Value E6 1990 US\$
1	Sun	1.47E+19 J	1	0.15	10
2	Rain	9.97E+15 J	1.82E+04	1.81	117
3	Soil used	2.36E+15 J	6.34E+04	1.50	97
4	Gasoline	2.37E+15 J	5.30E+04	1.26	81
5	Diesel	3.64E+15 J	5.30E+04	1.93	125
6	Natural Gas	6.21E+14 J	4.80E+04	0.30	19
7	Other Fuels	2.37E+07 \$	1.80E+12	0.43	28
8	Electricity	6.26E+14 J	1.59E+05	0.99	64
9	Nitrogen Fertilizer	1.45E+11 g	3.45E+09	4.99	322
10	Phosphate Fertilizer	1.45E+11 g	6.88E+09	9.95	642
11	Potassium Fertilizer	1.45E+11 g	2.96E+09	4.28	276
12	Agricultural Chemicals	5.24E+09 g	1.48E+10	0.78	50
13	Machinery, Trucks	8.48E+09 g	6.70E+09	0.57	37
14	Machinery, Tractors	7.89E+09 g	6.70E+09	0.53	34
15	Machinery, Other	7.89E+08 g	6.70E+09	0.05	3
16	Buildings	1.77E+07 \$	1.80E+12	0.32	21
17	Labor, unskilled	2.81E+13 J	8.90E+06	2.50	162
19	Labor, Skilled	3.43E+13 J	2.46E+07	8.44	544
20	Research	1.17E+11 J	3.43E+08	0.40	26
	Sum of 2-19 less 17			38.11	2459
21	Tobacco Produced	3.18E+15 J			
22	Transformity of tobacco		1.20E+06		

Footnotes for Table G-4

1 Sun

Annual Energy =

$$= (1.18e6 \text{ ac})(0.4071 \text{ ha/ac})(1.1e6 \text{ kcal/m}^2/\text{y})(1e4 \text{ m}^2/\text{ha})(8/12 \text{ y})(4186\text{J/kcal})$$

$$1.47E+19 \text{ J/y}$$

2 Evapotranspiration

Annual Energy =

$$= (1.18e6 \text{ ac})(0.4071 \text{ ha/ac})(1e4 \text{ m}^2/\text{ha}) \times (0.84\text{m/y}) \times (1/2 \text{ y}) \times 4.94 \text{ E6J/m}^3$$

$$9.97E+15 \text{ J/y}$$

3 Soil used

Erosion rate from cropland, MT/ha/y = 7.5 (USDA 1977)

Soil used, J/y = (area, ac)x(1 ha/2.47ac)x(7.5 MT/ha/y)x(1.5 E6 g/MT)x(3% OM)x(3.5 kcal/g)x(4186 J/kcal)

Soil used, J/y = 2.36E+15

4 Gasoline

$$\text{Annual Energy} = (\$17.9\text{e}6/\text{yr}) / (\$1.00/\text{gal}) \times (1.25\text{e}5 \text{ Btu}/\text{gal}) \times (1.06\text{e}3 \text{ J}/\text{Btu})$$

$$2.37\text{E}+15 \text{ J}/\text{y}$$

5 Diesel Fuel

$$\text{Annual Energy} = (\$17.3\text{e}6/\text{yr}) / (\$0.70/\text{gal}) \times (1.39\text{e}5 \text{ Btu}/\text{gal}) \times (1.06\text{e}3 \text{ J}/\text{Btu})$$

$$3.64\text{E}+15 \text{ J}/\text{y}$$

6 Natural Gas

$$\text{Annual Energy} = (\$3.1\text{e}6/\text{yr}) / (\$0.1925/\text{m}^3) \times (36.4\text{e}3 \text{ Btu}/\text{m}^3) \times (1.06\text{e}3 \text{ J}/\text{Btu})$$

$$6.21\text{E}+14 \text{ J}/\text{y}$$

7 Other Fuels

$$\text{Annual Dollars} = 23.7\text{e}6$$

$$2.37\text{E}+07 \text{ \$}$$

8 Electricity

$$\text{Annual Energy} = (\$13.9\text{e}6/\text{y}) / (\$0.08/\text{kwh}) \times (3.6\text{e}6 \text{ J}/\text{kwh})$$

$$6.26\text{E}+14 \text{ J}/\text{y}$$

9 Nitrogen Fertilizer

$$\text{Annual Mass Flow} = (\$69.4\text{e}6) \times (1/3) / (\$160/\text{MT}) \times (1\text{e}6 \text{ g}/\text{MT})$$

$$1.45\text{E}+11 \text{ g}/\text{y}$$

10 Phosphate Fertilizer

$$\text{Annual Mass Flow} = (\$69.4\text{e}6) \times (1/3) / (\$160/\text{MT}) \times (1\text{e}6 \text{ g}/\text{MT})$$

$$1.45\text{E}+11 \text{ g}/\text{y}$$

11 Potassium Fertilizer

$$\text{Annual Mass Flow} = (\$69.4\text{e}6) \times (1/3) / (\$160/\text{MT}) \times (1\text{e}6 \text{ g}/\text{MT})$$

$$1.45\text{E}+11 \text{ g}/\text{y}$$

12 Agricultural Chemicals

$$\text{Annual Mass Flow} = (\$41.5\text{e}6) / (\$3.6/\text{lb}) \times (454.5 \text{ g}/\text{lb})$$

$$5.24\text{E}+09 \text{ g}/\text{y}$$

13 Machinery, Trucks

$$\text{Annual Mass Flux} = (31,096 \text{ trucks}) \times (6000 \text{ lb}/\text{truck}) \times (454.5 \text{ g}/\text{lb}) \times (1/10)$$

Assume truck lifespan = 10 yrs

$$8.48\text{E}+09 \text{ g}/\text{y}$$

14 Machinery, Tractors

Annual Mass Flux = (43,404 tractors) x (8000 lb/tract.) x (454.5 g/lb) x (1/20)

Assume tractor lifespan = 20 yrs

$$7.89\text{E}+09 \text{ g/y}$$

15 Machinery, Other

Annual Mass Flux = $7.89\text{E}+08 \text{ g/y}$ (Assume equals 10% of Tractor mass)

16 Buildings

Assume buildings have lifespan of 30 years

1987 buidings = $\$5.3\text{e}8$

$$1.77\text{E}+07 \text{ \$}$$

17 Labor, unskilled

Annual Labor Costs = $\$94.0\text{e}6$

Average Wage Rate = $\$8.00/\text{hr}$

Assume Work Period = 5 months @ 40 hr/wk

Number of Workers = $(\$94\text{e}6/\text{yr}) / (\$8.00/\text{hr}) / 800 \text{ hr/worker-year}$

Number of Workers = 14,688

Annual Energy = (# of Workers) x (2500 kcal/d) x (4186 J/kcal) x (183 d/y)

Annual Energy, J/y = $2.81\text{E}+13$

19 Labor, Skilled

Skilled Labor Base on Owners Time

of Owners = 17911

Annual Energy = (# of Owners) x (2500 kcal/d) x (4186 J/kcal) x (183 d/y)

$$3.43\text{E}+13 \text{ J/y}$$

20 Research

Total Research for U.S. = 87.3 Scientist-yrs

N.C. Tobacco Production = 35% of U.S. Total

Annual Energy = (# of Scientists) x (2500 kcal/d) x (4186 J/kcal) x (365 d/y) x (35%)

$$1.17\text{E}+11 \text{ J/y}$$

21 Tobacco Production

Production, g/y = $2.17\text{E}+11$

Energy, J/y = $(\text{Production}) \times (3.5\text{kcal/g}) \times (4186\text{J/kcal})$

Energy, J/y = $3.18\text{E}+15$

22 Transformity of N.C. Leaf Tobacco

Total emergy inputs (sum of 2 through 19 less 17) divided by tobacco production

Table G-5. Computation of North Carolina trade in manufactured goods.

Standard Industrial Classification code	Description	U.S. Production labor-hours (1000's)	N.C. Production labor-hours (1000's)	U.S. per capita production, labor-hours per person	N.C. per capita production, labor-hours per person	N.C. exports (imports), 1000 labor-hours per year	US mean value of shipment per prod. hour, \$/hr	N.C. exports (imports), \$ per year
20	Food and kindred products	2,245,400	76,400	8.8	11.2	16,170	181	2.93E+09
21	Tobacco Products	51,300	21,700	0.2	3.2	20,324	686	1.39E+10
22&23	Textile Mill products & apparel	2,593,800	451,500	10.2	66.0	381,925	55	2.09E+10
24,25,26	Lumber, furniture, paper	2,858,500	219,500	11.2	32.1	142,825	90	1.29E+10
27	Printing & publishing	1,564,300	32,600	6.1	4.8	-9,360	107	-9.98E+08
28	Chemicals	1,007,700	49,200	4.0	7.2	22,170	303	6.72E+09
29	Petroleum & coal products	165,400	1,100	0.6	0.2	-3,337	907	-3.02E+09
30	Plastics	1,412,200	62,000	5.5	9.1	24,120	80	1.94E+09
32	Stone, clay, glass	742,500	30,400	2.9	4.4	10,484	84	8.81E+08
33,34	Primary and fabricated metals	2,744,200	67,700	10.8	9.9	-5,909	90	-5.31E+08
35,36,37,38, 39	Machinery, Electronics, transport. Equipment, Instruments	7,657,700	203,600	30.0	29.8	-1,807	137	-2.47E+08
	Total	23.0E+6	1,215,700	90.4	177.7	597,605	127	5.54E+10

REFERENCES

- API, 1989. American Paper Institute's annual report.
- Ashton, P.S., 1964. Ecological studies in the mixed dipterocarp forest of Brunei State. Clarendon Press, Oxford.
- Baas, P., K. Kalkman, and R. Geesink, 1990. The plant diversity of Malesia. Kluwer Academic, Dordrecht. 420 pp.
- Barry, R.G. & R.J. Chorley, 1992. Atmosphere, weather and climate. 6th ed. Routledge, London. 392. pp.
- Beyer, F., 1991. North Carolina: the years before man, a geologic history. Carolina Academic Press, Durham, NC. 244 pp.
- Bogges, C.F., 1995. The biogeoconomics of phosphorus in the Kissimmee Valley. Ph.D. dissertation, University of Florida, Gainesville. 234 pp.
- Boring, L.R., C.D. Monk, and W.T. Swank, 1981. Early regeneration of a clear-cut southern Appalachian forest. *Ecology* 62(5):1244-1253.
- Boring, L.R., W.T. Swank, and C.D. Monk, 1988. Dynamics of early successional forest structure and processes in the Coweeta basin. In: *Forest hydrology and Ecology at Coweeta*, W.T. Swank and D.A. Crossley, Jr. (eds). Springer-Verlag, New York, NY.
- Brown, M.J., 1990. North Carolina's Forests. USDA, Forest Service, Southeastern Forest Experiment Station, Asheville, NC. Resource Bulletin, SE-142.
- Brown, M.T. and R.A. Herendeen, 1996. Embodied energy analysis and emergy analysis: a comparative view. *Ecological Economics* 19:219-235.
- Brown, M.T. and S. Ulgiati, 1999. Emergy evaluation of natural capital and biosphere services. *Ambio* (in press)
- Buranakarn, V., 1998. Evaluation fo recycling and reuse of building materials using the emergy analysis method. Ph.D. dissertation, University of Florida, Gainesville. 258pp.

- Cavelier, J., 1995. Reforestation with the native tree *Alnus acuminata*: effects on phytodiversity and species richness in an upper montane rain forest area of Colombia, pp. 125-137. In: Tropical montane cloud forests. Hamilton, L.S., J.O. Juvik, and F.N. Scatena (eds). Springer-Verlag, New York. 407 pp.
- Chorley, R.J., S.A. Schumm, and D.E. Suddgen, 1984. *Geomorphology*. Methuen Co. London.
- Clay, J.W., D.M. Orr, Jr., and A.W. Stuart, 1975. *North Carolina Atlas: portrait of a changing southern state*. University of North Carolina, Chapel Hill, NC. 177 pp.
- Clayton, J.L., 1986. An estimate of plagioclase weather rate in the Idaho Batholith based upon geochemical transport rates. Pp. 453-466. In: Rates of chemical weathering of rocks and minerals (S.E. Colman and D.P. Dethier, eds.) Academic Press, Orlando, FL. 603 pp.
- Commodity Research Bureau (CRB), 1960. *Commodity Yearbook 1960*. Commodity Research Bureau, New York, NY.
- Commodity Research Bureau, 1986. *Commodity Yearbook 1986*. Jersey City, NJ.
- Commodity Research Bureau-Knight Ridder Financial, 1996. *Commodity Yearbook 1960*. John Wiley & Sons, New York, NY.
- Cordell, H.K., R.J. Teasley, and J. Bergstrom, 1996. CUSTOMER: Wine Spring Creek watershed. Final report, Southeastern Forest Experiment Station, Athens, GA. 88 pp.
- Corder, S.E., 1975. Fuel characteristics of wood and bark and factors affecting heat recovery. Proc. Conf. Wood Residue as an Energy Source. For. Prod. Res. Soc.
- Costain, J.K., Speer, J.A., Glover, L., Perry, L., Dashevsky, S. and McKinney, M., 1986. Heat flow in the piedmont and atlantic coastal plain of the southeastern United States. *J. Geophys. Res.*, 91, No. B2, 2123-2135.
- Creasey, J. A.C. Edwards, J.M Reid, D.A. MacLeod, and M.S. Cresser, 1986. The use of cathment studies for assessing chemical weathering rates in two contrasting upland areas in northeast Scotland. Pp. 467-502. In: Rates of chemical weathering of rocks and minerals, S.E. Colman and D.P. Dethier, eds. Academic Press, Orlando, FL. 603 pp.
- Dailey, G. C. (ed.), 1997. *Nature's Services: societal dependence on natural ecosystems*. Island Press, Washington, DC. 392 pp.
- Day, F.P. and C.D. Monk, 1977. Net primary production and phenology on a southern Appalachian watershed. *Amer. J. Bot.* 64(9):1117-1125.

- Diamond, C., 1984. Energy basis for the regional organization of the Mississippi River basin. M.S. thesis, University of Florida, Gainesville, 136 pp.
- Doherty, S.J., 1995. Emergy evaluations of and limits to forest production. Ph.D. dissertation, University of Florida, Gainesville. 215 pp.
- Doherty, S.J., F.N. Scatena, and H.T. Odum, 1997. Emergy evaluation fo the Luquillo Experimental Forest and Puerto Rico. Final report to International Institute of Tropical Forestry, Rio Piedras, Puerto Rico.
- Douglass, J.E. and W.T. Swank, 1975. Effects of management practices on water quality and quantity: Coweeta Hydrologic Laboratory, Otto, North Carolina: U.S. Dept. of Agr. Forest Service. Gen. Tech. Rept. NE-13, p. 1-13.
- Elliot, K.J., R.L. Hendrick, A.E. Major, J.M. Vose, W.T. Swank, 1999. Vegetation dynamics after a prescribed fire in the southern Appalachians. *Forest Ecology and Management* 114:2-3(199-213)
- Elliot, K.J., and D. Hewitt, 1997. Forest species diversity in upper elevation hardwood forests in southern Appalachian mountains. *Castanea* 62(1):32-42.
- Energy Information Administration (EIA), 1991. Manufacturing Consumption of Energy: Total primary consumption of energy for all purposes by census region, industry group, and selected industries, 1991 (Part 1), Washington, DC.
- English, D.B.K., 1995. Baseline economic conditions near the Wine Spring Creek watershed: Draft report and research proposal, Wine Spring Creek Ecosystem Management Research. USDA Forest Service, Coweeta Hydrologic Lab, Otto, NC.
- FAO (Food and Agricultural Organization), 1996. FAO Yearbook 1983-1994: FAO Forestry Series #29. Food & Agricultural Organization of United Nations, Rome.
- FAO, 1997. State of the World's Forests, 1997. Food and Agriculture Organization of the United Nations, Rome.
- FAO, 1999. On-line database accessed via web server of Food and Agricultural Organization of United Nations.
<http://www.fao.org/WAICENT/FAOINFO/FORESTRY/forestry.htm>.
- Federal Energy Regulatory Commission, 1981. Water resources appraisal for hydroelectric licensing: Little Tennessee River Basin. FERC-0066.
- Geraghty, J., D. Miller, F. van der Leeden, and F. Troise, 1973. Water Atlas of U.S. Water Information Center Publication, Port Washington, NY.

- Hamilton, L.S., J.O. Juvik, F.N. Scatena (eds.), 1995. Tropical montane cloud forests. Springer-Verlag, New York. 407 pp.
- Handel, M.D., 1996. Water vapor. In: Encyclopedia of Climate and Weather. Schneider, S.H. (ed). Oxford University Press, New York.
- Haurwitz, B. and J.M. Austin, 1944. Climatology. New York, McGraw-Hill. 410 pp.
- Haygreen, J.G. and J.L. Bowyer, 1982. Forest Products and Wood Science: An Introduction. Iowa State Univ. Press, Ames, IA. 495 pp.
- Helvey, J.D. and J.H. Patric, 1988. Research on interception losses and soil moisture relationships. pp. 129-137. In: Forest hydrology and Ecology at Coweeta, W.T. Swank and D.A. Crossley, Jr. (eds). Springer-Verlag, New York.
- Howington, T., 1999. A spatial analysis of emergy of an internationally shared drainage basin and the implications for policy decisions. Ph.D. dissertation. University of Florida, Gainesville.
- Hughes, J.D. and J.V. Thirgood, 1982. Deforestation in ancient Greece and Rome: a cause of collapse? *The Ecologist* 12:196-208.
- Johnson, T.G., 1994. North Carolina Timber Industry: An Assessment of Timber Product Output and Use, 1992. USDA, Forest Service, Southeastern Forest Experiment Station, Asheville, NC. Resource Bulletin, SE-146.
- Kartawinata, K. R. Abdulhadi, and T. Paromihardjo, 1981. Composition and structure of a lowland Dipterocarp forest at Wanariset, East Kalimantan. *Malaysian Forester* 44(2&3):397-406.
- Keitt, T.H., 1991. Hierarchical organization of energy and information in a tropical rain forest ecosystem. M.S. thesis, University of Florida, 72 pp.
- Keller, P.A., 1992. Perspectives on interfacing paper mill wastewaters and wetlands. M.S. thesis. Gainesville, FL.
- Kharecha, P., 1997. Energy evaluation of the effects of human activities on Luquillo Experimental Forest, Puerto Rico. M.S. project, University of Florida, Gainesville. 38 pp.
- Kitayama, Kanehiro, 1995. Biophysical conditions of the montane cloud forests of Mount Kinabalu, Sabah, Malaysia. In: Tropical montane cloud forests, L.S. Hamilton, J.O. Juvik, F.N. Scatena (eds.). Springer-Verlag, pp 183-197.
- Kurth, E.F., 1952. The volatile oils, pp. 548-589. In: Wood Chemistry, 2nd ed., Wise, L.E. and E.C. Jahn, eds. Reinhold Publishing, New York.

- Lewis, H.E., L. Johnson, and D. Askins, 1978. Colonialism in Modern America: The Appalachian Case. The Appalachian Consortium Press, Boone, NC. 370 pp.
- Lyke, J., 1998. The impact of the NAFTA on US forest products trade with Canada and Mexico: An assessment. *Forest Products Journal*, 48(1):23-28.
- Mather, A.S., 1990. Global forest resources. Belhaven Press, London. 341 pp.
- McGrane, G., 1998. Simulating whole-earth cycles using hierarchies and other general systems concepts. Ph.D. dissertation, University of Florida, Gainesville. 372 pp.
- Myers, N., 1997. The world's forests and their ecosystem services. In: *Nature's services: societal dependence on natural ecosystems* (G.C. Daily, ed.) Island Press, Washington, D.C.
- National Marine Fisheries Service, 1995. Fisheries of the US, 1994. NOAA, Current Fisheries Statistics #9400
- New, M., M. Hulme, and P.D. Jones, 1998. Representing twentieth century space-time climate variability. Part 1: development of a 1961-90 mean monthly terrestrial climatology. *J.Climate*.
- North Carolina Department of Environment, Health, and Natural Resources (NCDEHNR), 1992. Water quality progress in North Carolina 1990-1991 305b Report. N.C. Dept. of Environment, Health, and Natural Resources, Raleigh.
- Odum, E.P. and H.T. Odum, 1972. Natural areas as necessary components of man's total environment. Transactions for the Thirty-seventh North American Wildlife and Natural Resources Conference, March 12-15. Wildlife Management Institute, Washington, DC.
- Odum, H.T., 1970. A tropical rain forest: a study of irradiation and ecology at El Verde, Puerto Rico. Division of Technical Information, U.S. Atomic Energy Commission. Washington, DC.
- Odum, H.T., 1995. Tropical forests systems and the human economy. In: *Tropical forests: Management and ecology*. A.E. Lugo and C. Lowe, eds. Springer-Verlag, New York.
- Odum, H.T., 1996. *Environmental Accounting: Energy and environmental decision making*. John Wiley, New York. 370 pp.
- Odum, H.T. and E.C. Odum, in press. *Modelling for All Scales*. Academic Press, San Diego.

- Odum, H.T., C. Diamond, and M.T. Brown, 1987. Energy systems overview of the Mississippi River Basin. Center for Wetlands Publication #87-1, University of Florida. 107 pp.
- Odum, H.T., M.S. Romitelli, and R. Tighe, 1998. Evaluation overview of the Cache River and Black Swamp in Arkansas. Final report to Waterways Experiment Station, U.S. Dept. of Army, Vicksburg, MS. 127 pp.
- Orrell, J.J., 1998. Cross scale comparison of plant and production diversity. M.S. thesis, University of Florida, Gainesville. 159 pp.
- Paces, T., 1986. Rates of weathering and erosion derived from mass balance in small drainage basins. In: *Rates of Chemical Weathering of Rocks and Minerals*, Colman, S.M. and D.P. Dethier, eds. Academic Press, Orlando, FL. 603 pp.
- Pajmans, K., 1970. An analysis of four tropical rain forest sites in New Guinea. *J. Ecol.* 58(1):77-101.
- Parker, N. 1998. Spatial models of total phosphorus loading and landscape development intensity in a north Florida watershed. M.E. thesis, University of Florida, Gainesville. 123 pp.
- Peixoto, J.P. and A.H. Oort, 1996. The climatology of relative humidity in the atmosphere. *J. Clim.* 9(12):3443-3463.
- Pollack, H.N., S.J. Hurter, and J.R. Johnson, 1991. A new global heat flow compilation. Department of Geological Sciences, U. of Mich., Ann Arbor.
- Romitelli, M.S., 1997. Energy analysis of watersheds. Ph.D. dissertation, University of Florida, Gainesville. 292 pp.
- Romitelli, M.S. and Odum, H.T., 1996. Energy analysis of Coweeta River basin, N.C. Final report to the U.S. Dept. of Agriculture Coweeta Hydrologic Laboratory, Otto, NC.
- Rosen, R.D., D.A. Salstein, J.P. Peixoto, 1979a. Variability in the annual fields of large-scale atmospheric water vapor transport. *Monthly Weather Review* 107:26-37.
- Rosen, R.D., D.A. Salstein, J.P. Peixoto, 1979b. Streamfunction analysis of interannual variability in large-scale water vapor flux. *Monthly Weather Review* 107:1682-1684.
- Scatena, F.N., 1995. The management of Luquillo elfin cloud forest ecosystems: Irreversible decisions in a nonsubstitutable ecosystem, pp. 296-308. In: *Tropical montane cloud forests*. Hamilton, L.S., J.O. Juvik, and F.N. Scatena (eds). Springer-Verlag, New York. 407 pp.

- Sclater, J.G., C. Jaupart, and D. Galson, 1980. The heat flow through oceanic and continental crust and the heat loss of the earth. *Reviews of Geophysics and Space Physics*, 18(1):269-311.
- Sheffield, R.M. and H.A. Knight, 1986. North Carolina's forests. Resource bulletin SE-88. US Department of Agriculture Forest Service, Southeastern Experiment Station. Asheville, NC.
- Sikich, S.W., P.A. Carpenter III, L.S. Wiener, 1992. Annual Report North Carolina. U.S. Dept. of Interior, Bureau of Mines.
- Simmons, C.E., 1993. Sediment characteristics of North Carolina Streams, 1970-79. USGS Water Supply Paper 2364.
- Singh, J.S., S.P. Singh, A.K. Saxena and Y.S. Rawat, 1984. The forest vegetation of Silent Valley, India, pp. 25-52. In: *Tropical rain-forest: The Leeds symposium*, A.C. Chadwick and S.L. Sutton (ed). Leeds.
- Smith, D.L., R.G. Gregory, and J.W. Emhof, 1981. Geothermal measurements in the Southern Appalachian Mountains and Southeastern Coastal Plain. *Amer. J. Sci.*, 281, 282-298.
- Smith, D.L., R.G. Gregory, and M.J. Garvey, 1978. A thermal reconnaissance of Georgia heat flow and radioactive heat generation. *Geol. Surv. of Georgia Bull.*, 93, 93-104.
- Southern Appalachian Assessment, 1996. Southern Appalachian Man and the Biosphere Program, Norris, TN.
- Springer, A.M., 1986. Industrial environmental control: pulp and paper industry. John Wiley, New York. pp. 430
- Steer, H.B., 1948. Lumber production in the U.S. 1799-1946. U.S. Department of Agriculture, Miscellaneous Publication #669.
- Swaney, D.P., 1978. Energy analysis of climatic inputs to agriculture. MS thesis, University of Florida, 198 pp.
- Swank, W.S., 1998. Wine Spring Creek ecosystem demonstration project. North American Forestry Research Conference. Raleigh, NC.
- Swank, W.S. and D.A. Crossley, 1988. Forest hydrology and ecology at Coweeta. Springer-Verlag, New York. 469pp.
- Swift, L.W., G.B. Cunningham, and J.E. Douglass, 1988. Climatology and hydrology pp. 35-55. In: *Forest hydrology and Ecology at Coweeta*, W.T. Swank and D.A. Crossley, Jr. (eds). Springer-Verlag, New York.

- Swift, L.W. and W.T. Swank, 1981. Long term responses of streamflow following clearcutting and regrowth. *Hydrological Sciences Bulletin* 26(3):245-256.
- Tilley, D.R., 1996. Benefits of ecologically engineered stormwater management systems in urban watersheds south of Miami, Florida. M.E. thesis, University of Florida, Gainesville. 206 pp.
- Timber Mart-South, 1997. Stumpage and F.O.B. Price mart. Daniel B. Warnell School of Forest Resources, University of Georgia. Athens.
- Ulrich, A.H., 1990. U.S. timber production, trade, consumption, and price statistics 1960-88. USDA Forest Service, Miscellaneous Publication No. 1486. Washington. 80 pp.
- Ulrich, L.L., 1989. Raw water treatment, pp. 1-6. In: *Water supply and treatment*, 2nd ed. J.G. Walters, ed. TAPPI, Atlanta, GA. pp. 87.
- UNESCO, 1978. World water balance and water resources of the earth, UNESCO studies and reports in hydrology 25,1978. United Nations.
- U.S. Bureau of Mines, 1992. Annual Report of North Carolina. U.S. Geologic Survey.
- U.S. Census Bureau, 1992. Economic Census:Census of Manufactures, Department of Commerce. Washington, DC.
- U.S. Department of Commerce, Bureau of the Census. <http://www.doc.gov/>
- USDA, 1996. Soil survey of Macon County, North Carolina. Natural Resources Conservation Service, Washington, DC.
- U.S. Forest Service, 1995. Wine Spring Creek Ecosystem Management Project: Summary of research results. Coweeta Hydrologic Laboratory, Otto, NC.
- U.S. Forest Service, 1999. Southern Research Station, Forest Inventory and Analysis. <http://www.srfia.usfs.msstate.edu/>
- U.S. Travel Data Center, 1996. Impact of travel on state economies, 1994. Research Dept. of Travel Industry Assoc. of America.
- Velbel, M.A., 1985. Geochemical mass balances and weathering rates in forested watersheds of the southern Blue Ridge. *Am. J. Sci.* 285:904-930.
- Velbel, M.A., 1988. Weathering and soil-forming processes. In: *Forest hydrology and Ecology at Coweeta*, W.T. Swank and D.A. Crossley, Jr. (eds). Springer-Verlag, New York.

- Vose, J.M., W.T. Swank, B.D. Clinton, J.D. Knoepp, L.W. Swift, 1999. Using stand replacement fires to restore southern Appalachian pine-hardwood ecosystems: effects on mass, carbon, and nutrient pools. *Forest Ecology and Management* 114:2-3(215-226)
- Whisnant, D.E., 1994. *Modernizing the Mountaineer: people, power, and planning in Appalachia*. Rev. ed. Univ. of Tennessee Press, Knoxville. 310 pp.
- Whitmore, T.C. (ed), 1984. *Tropical rain forests of the Far East* (2 ed). Clarendon Press, Oxford, 352 pp.
- Whitmore, T.C. and K. Sidiyasa, 1986. Composition and structure of a lowland rain forest at Toraut, northern Sulawesi. *Kew Bulletin* 41(3):747-756.

BIOGRAPHICAL SKETCH

David Rogers Tilley was born in Greensboro, NC, the 31st day of January, 1969. He attended Oak Ridge Elementary, Northwest Guilford Junior High and Northwest Guilford Senior High, all located in Guilford County, NC. In 1987, David entered the College of Engineering at North Carolina State University in Raleigh. While in school he participated in the cooperative education program, working as an industrial engineer first at Thomasville Furniture Industries in Thomasville, NC and then at Phillip Morris, U.S.A. in Richmond, VA. He received a B.S. in industrial engineering and a B.S. in furniture manufacturing and management in December 1992.

David held a management engineering position with Cape Fear Valley Medical Center in Fayetteville, NC after graduating from NCSU. Exposure to systems engineering and computer simulation modelling during David's undergraduate education and his fascination with nature combined to inspire his interest in ecological and general systems. David received his M.E. in environmental engineering from the University of Florida with an emphasis in systems ecology in August 1996.

From 1996 to 1999 David pursued his doctoral degree in the systems ecology program of the Department of Environmental Engineering Sciences at the University of Florida.

After graduation, David took a position as an assistant professor of environmental engineering at Texas A&M Kingsville.